



The new generation of energy-saving LED PLS tube lighting

CorePro LED PLS

The Philips CorePro LED PLS integrates a LED light source into a traditional fluorescent form factor. This product is the ideal solution for uplamping in general lighting applications: it meets basic lighting requirements, offers significant energy savings, and is environment-friendly.

Benefits

- Reduced operational cost thanks to lower energy consumption
- Lower maintenance cost thanks to 2-3 times longer lifetime than conventional lamps
- Fastest and easiest way to upgrade existing luminaires to LED technology; completely safe product and installation process

Features

- Highly energy-efficient
- Easy installation
- Conventional form factor to fit into existing luminaires
- No mercury

Application

- Hospitality, retail, office, industrial and home applications

CorePro LED PLS

Versions



CorePro-LED-PLS-360D-5W-3CCT-2P-G23



CorePro LED PLS 2P G23

Dimensional drawing

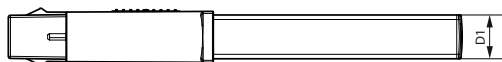
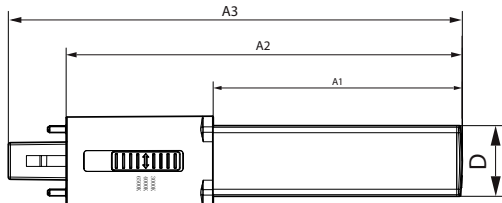
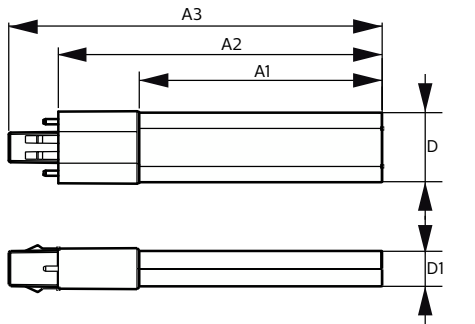
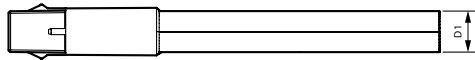
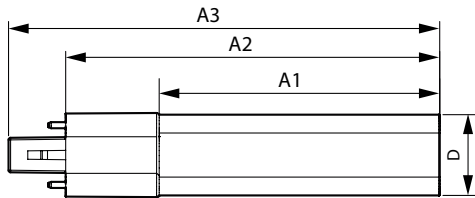

Product	D1	D	A1	A2	A3
CorePro LED PLS 3.5W 830 2P G23	16 mm	31 mm	79 mm	115 mm	137 mm
CorePro LED PLS 3.5W 840 2P G23	16 mm	31 mm	79 mm	115 mm	137 mm
CorePro LED PLS 5W 830 2P G23	16 mm	31 mm	108 mm	144 mm	166 mm
CorePro LED PLS 5W 840 2P G23	16 mm	31 mm	108 mm	144 mm	166 mm

Product	D1	D2	A1	A2	A3
CorePro LED PLS 5W 830 2P G23	15.8 mm	15.8 mm	108 mm	144 mm	166 mm
CorePro LED PLS 5W 840 2P G23	15.8 mm	15.8 mm	108 mm	144 mm	166 mm

Product	D1	D	A1	A2	A3
CorePro LED PLS 360D 5W 3CCT 2P G23	16 mm	26 mm	91 mm	145 mm	166 mm

CorePro LED PLS

Product details

Product detail image



General Information	
Cap-Base	G23
Switching Cycle	50,000
Nominal lifetime	30,000 hour(s)
Light Technical	
LLMF At End Of Nominal Lifetime (Nom)	70 %
Operating and Electrical	
Input Frequency	50 to 60 Hz
Starting Time (Nom)	0.5 s
Controls and Dimming	
Dimmable	No
Mechanical and Housing	
Bulb Shape	PL-S

Light Technical (1/2)

Order Code	Full Product Name	Beam Angle (Nom)	Correlated Color Temperature (Nom)	Color rendering index (CRI)	Color Code
929001926302	CorePro LED PLS 5W 830 2P G23	120 degree(s)	3000 K	82	830
929001926402	CorePro LED PLS 5W 840 2P G23	120 degree(s)	4000 K	82	840
929003756802	CorePro LED PLS 5W 830 2P G23	120 degree(s)	3000 K	82	830
929003756902	CorePro LED PLS 5W 840 2P G23	120 degree(s)	4000 K	82	840
929004350102	CorePro LED PLS 360D 5W 3CCT 2P G23	360 degree(s)	3000 K	80	3000/4000/6500
929003756602	CorePro LED PLS 3.5W 830 2P G23	120 degree(s)	3000 K	82	830
929003756702	CorePro LED PLS 3.5W 840 2P G23	120 degree(s)	4000 K	82	840

Light Technical (2/2)

Order Code	Full Product Name	Luminous Flux	Order Code	Full Product Name	Luminous Flux
929001926302	CorePro LED PLS 5W 830 2P G23	520 lm	929004350102	CorePro LED PLS 360D 5W 3CCT 2P G23	500 lm
929001926402	CorePro LED PLS 5W 840 2P G23	550 lm	929003756602	CorePro LED PLS 3.5W 830 2P G23	360 lm
929003756802	CorePro LED PLS 5W 830 2P G23	520 lm	929003756702	CorePro LED PLS 3.5W 840 2P G23	390 lm
929003756902	CorePro LED PLS 5W 840 2P G23	550 lm			

Operating and Electrical

Order Code	Full Product Name	Line Frequency	Power Consumption	Wattage Equivalent	Order Code	Full Product Name	Line Frequency	Power Consumption	Wattage Equivalent
929001926302	CorePro LED PLS 5W 830 2P G23	50 to 60 Hz	5 W	-	929004350102	CorePro LED PLS 360D 5W 3CCT 2P G23	-	5 W	9 W
929001926402	CorePro LED PLS 5W 840 2P G23	50 to 60 Hz	5 W	-	929003756602	CorePro LED PLS 3.5W 830 2P G23	-	3.5 W	-
929003756802	CorePro LED PLS 5W 830 2P G23	-	5 W	-	929003756702	CorePro LED PLS 3.5W 840 2P G23	-	3.5 W	-
929003756902	CorePro LED PLS 5W 840 2P G23	-	5 W	-					

CorePro LED PLS

Temperature

Order Code	Full Product Name	T-Case Maximum (Nom)
929001926302	CorePro LED PLS 5W 830 2P G23	83 °C
929001926402	CorePro LED PLS 5W 840 2P G23	83 °C
929003756802	CorePro LED PLS 5W 830 2P G23	50 °C
929003756902	CorePro LED PLS 5W 840 2P G23	50 °C

Order Code	Full Product Name	T-Case Maximum (Nom)
929004350102	CorePro LED PLS 360D 5W 3CCT 2P G23	75 °C
929003756602	CorePro LED PLS 3.5W 830 2P G23	45 °C
929003756702	CorePro LED PLS 3.5W 840 2P G23	45 °C

Mechanical and Housing

Order Code	Full Product Name	Bulb Finish
929001926302	CorePro LED PLS 5W 830 2P G23	-
929001926402	CorePro LED PLS 5W 840 2P G23	-
929003756802	CorePro LED PLS 5W 830 2P G23	Frosted
929003756902	CorePro LED PLS 5W 840 2P G23	Frosted

Order Code	Full Product Name	Bulb Finish
929004350102	CorePro LED PLS 360D 5W 3CCT 2P G23	Frosted
929003756602	CorePro LED PLS 3.5W 830 2P G23	Frosted
929003756702	CorePro LED PLS 3.5W 840 2P G23	Frosted

Approval and Application

Order Code	Full Product Name	Ambient temperature range	Energy Consumption kWh/1000 h
929001926302	CorePro LED PLS 5W 830 2P G23	-20 °C to 45 °C	5 kWh
929001926402	CorePro LED PLS 5W 840 2P G23	-20 °C to 45 °C	5 kWh
929003756802	CorePro LED PLS 5W 830 2P G23	-20 to +45 °C	5 kWh
929003756902	CorePro LED PLS 5W 840 2P G23	-20 to +45 °C	5 kWh
929004350102	CorePro LED PLS 360D 5W 3CCT 2P G23	-20 to +45 °C	5 kWh
929003756602	CorePro LED PLS 3.5W 830 2P G23	-20 to +45 °C	4 kWh
929003756702	CorePro LED PLS 3.5W 840 2P G23	-20 to +45 °C	4 kWh

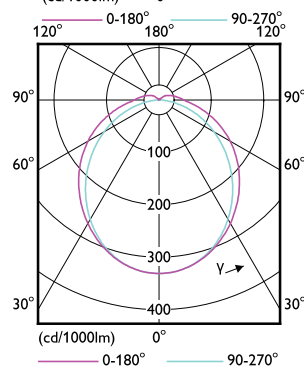
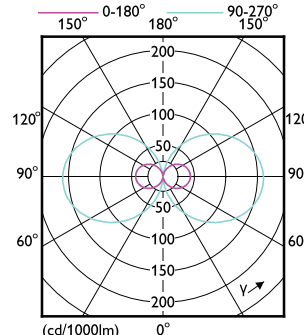
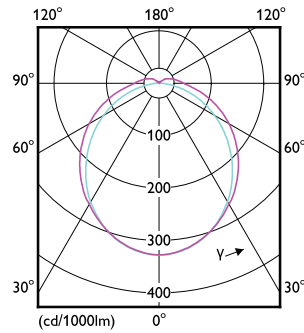
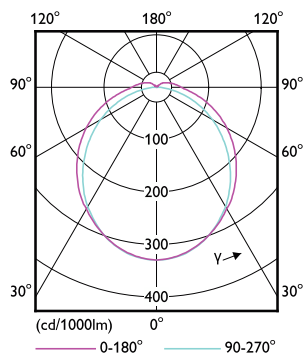

CorePro LED PLS

