



# Untuk kinerja terbaik dan keberlanjutan

## MASTER LED tube InstantFit HF T5

Philips MASTER LEDtube InstantFit T5 mengintegrasikan sumber cahaya LED ke dalam bentuk fluorezen konvensional. Desainnya yang unik menciptakan penampilan visual yang seragam sehingga Anda tidak dapat membedakannya dengan fluorezen konvensional. Philips MASTER LEDtube InstantFit T5 adalah solusi yang ideal untuk pelanggan yang memiliki persyaratan lampu yang lebih tinggi dan keinginan untuk memaksimalkan nilai terhadap masa pakai. Penghematan energi & masa pakai yang lama menghasilkan waktu titik impas yang lebih menarik.

### Benefits

- Pengurangan biaya operasional berkat pemakaian energi yang lebih rendah
- Biaya perawatan yang lebih rendah berkat masa pakai 2-3 kali lebih lama daripada lampu tabung fluorezen biasa
- Cara tercepat dan termudah untuk meningkatkan lampu lama ke teknologi LED, dengan proses pemasangan yang 100% aman

### Features

- Pengganti retrofit untuk lampu T5 yang sudah menggunakan ballast HF (Frekuensi Tinggi)
- Kompatibilitas HF: tidak ada kabel yang diganti, penggantian driver tanpa gangguan; Solusi InstantFit kami bekerja dengan balast elektronik Frekuensi Tinggi, membuatnya mudah dan aman untuk semua metode instalasi
- Keamanan Pin Elektronik: dengan produk Philips Anda dapat menyentuh dengan aman tutup ujung lain saat memasang tabung. Driver terintegrasi juga terisolasi dengan aman dari bagian yang dapat disentuh. Tabung LED Philips mematuhi semua persyaratan keamanan UL dan IEC

# MASTER LED tube InstantFit HF T5

## Application

- Kantor
- Sekolah
- Retail

## Versions



MAS LEDtube HF 1500mm 26W G5 T5 HO

## Dimensional drawing

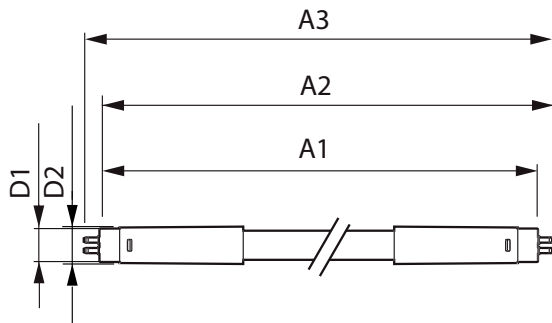

Product	D1	D2	A1	A2	A3
MAS LEDtube HF 1200mm HE 16.5W 830 T5	15,5 mm	18,8 mm	1.149 mm	1.156,1 mm	1.163,2 mm
MAS LEDtube HF 1200mm HE 16.5W 840 T5	15,5 mm	18,8 mm	1.149 mm	1.156,1 mm	1.163,2 mm
MAS LEDtube HF 1200mm HE 16.5W 865 T5	15,5 mm	18,8 mm	1.149 mm	1.156,1 mm	1.163,2 mm
MAS LEDtube HF 1500mm HE 20W 840 T5	15,5 mm	18,8 mm	1.449 mm	1.456,1 mm	1.463,2 mm
MAS LEDtube HF 1500mm HE 20W 865 T5	15,5 mm	18,8 mm	1.449 mm	1.456,1 mm	1.463,2 mm
MAS LEDtube HF 1500mm UO 36W 830 T5	15,5 mm	19 mm	1.449 mm	1.456 mm	1.463 mm
MAS LEDtube HF 1500mm UO 36W 840 T5	15,5 mm	19 mm	1.449 mm	1.456 mm	1.463 mm
MAS LEDtube HF 1500mm UO 36W 865 T5	15,5 mm	19 mm	1.449 mm	1.456 mm	1.463 mm
MAS LEDtube HF 600mm HE 7W 840 T5	15,7 mm	19 mm	549 mm	556 mm	563 mm
MAS LEDtube HF 600mm HE 7W 865 T5	15,7 mm	19 mm	549 mm	556 mm	563 mm

# MASTER LED tube InstantFit HF T5

## Dimensional drawing

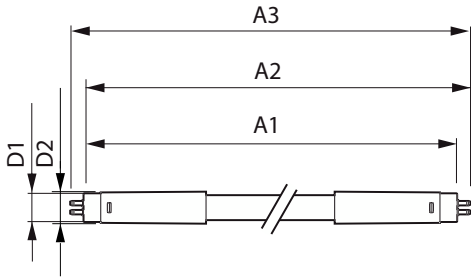

D1	D2	A1	A2	A3
15.5mm	18.8mm	549mm	556.1mm	563.2mm

Product	D1	D2	A1	A2	A3
MAS LEDtube HF 600mm HE 8W 840 T5 AP	15,7 mm	19 mm	549 mm	556,1 mm	563,2 mm

### Informasi Umum

Tutup-Dasar	G5
Siklus Sakelar	50.000

### Teknis Lampu

Sudut Cahaya (Nom)	200 °
LLMF di Akhir Masa Pakai Nominal (Nom)	70 %

### Pengoperasian dan Kelistrikan

Waktu Mulai (Nom)	0,5 s
-------------------	-------

### Mekanis dan Housing

Lapisan bohlam	Suram
Bentuk Bohlam	T5

## Informasi Umum

Order Code	Full Product Name	Nominal masa pakai
929003153902	MAS LEDtube HF 1500mm UO 36W 830 T5	60.000 jam
929003154002	MAS LEDtube HF 1500mm UO 36W 840 T5	60.000 jam
929003154102	MAS LEDtube HF 1500mm UO 36W 865 T5	60.000 jam
929001391002	MAS LEDtube HF 1200mm HE 16.5W 830 T5	60.000 jam
929001391102	MAS LEDtube HF 1200mm HE 16.5W 840 T5	60.000 jam
929001391202	MAS LEDtube HF 1200mm HE 16.5W 865 T5	60.000 jam

Order Code	Full Product Name	Nominal masa pakai
929001391402	MAS LEDtube HF 1500mm HE 20W 840 T5	60.000 jam
929001391502	MAS LEDtube HF 1500mm HE 20W 865 T5	60.000 jam
929001399508	MAS LEDtube HF 600mm HE 8W 840 T5 AP	50.000 jam
929003795202	MAS LEDtube HF 600mm HE 7W 840 T5	60.000 jam
929003795302	MAS LEDtube HF 600mm HE 7W 865 T5	60.000 jam

## Teknis Lampu

Order Code	Full Product Name	Suhu Warna Terkorelasi (Nom)	Indeks renderasi		
			warna (CRI)	Kode Warna	Flux Cahaya
929003153902	MAS LEDtube HF 1500mm UO 36W 830 T5	3000 K	80	830	5.200 lm
929003154002	MAS LEDtube HF 1500mm UO 36W 840 T5	4000 K	80	840	5.600 lm

Order Code	Full Product Name	Suhu Warna Terkorelasi (Nom)	Indeks renderasi		
			warna (CRI)	Kode Warna	Flux Cahaya
929003154102	MAS LEDtube HF 1500mm UO 36W 865 T5	6500 K	80	865	5.600 lm
929001391002	MAS LEDtube HF 1200mm HE 16.5W 830 T5	3000 K	80	830	2.300 lm

## MASTER LED tube InstantFit HF T5

Order Code	Full Product Name	Suhu Warna	Indeks		Flux Cahaya
		Terkorelasi (Nom)	renderasi warna (CRI)	Kode Warna	
929001391102	MAS LEDtube HF 1200mm HE 16.5W 840 T5	4000 K	80	840	2.500 lm
929001391202	MAS LEDtube HF 1200mm HE 16.5W 865 T5	6500 K	80	865	2.500 lm
929001391402	MAS LEDtube HF 1500mm HE 20W 840 T5	4000 K	80	840	3.000 lm
929001391502	MAS LEDtube HF 1500mm HE 20W 865 T5	6500 K	80	865	3.000 lm

Order Code	Full Product Name	Suhu Warna	Indeks		Flux Cahaya
		Terkorelasi (Nom)	renderasi warna (CRI)	Kode Warna	
929001399508	MAS LEDtube HF 600mm HE 8W 840 T5 AP	4000 K	83	840	1.050 lm
929003795202	MAS LEDtube HF 600mm HE 7W 840 T5	4000 K	80	840	1.050 lm
929003795302	MAS LEDtube HF 600mm HE 7W 865 T5	6500 K	80	865	1.050 lm

### Pengoperasian dan Kelistrikan

Order Code	Full Product Name	Frekuensi Input	Frekuensi Garis	Konsumsi Daya	Watt yang setara
					Setara
929003153902	MAS LEDtube HF 1500mm UO 36W 830 T5	30K hingga 100K Hz	30K to 100K Hz	36 W	-
929003154002	MAS LEDtube HF 1500mm UO 36W 840 T5	30K hingga 100K Hz	30K to 100K Hz	36 W	-
929003154102	MAS LEDtube HF 1500mm UO 36W 865 T5	30K hingga 100K Hz	30K to 100K Hz	36 W	-
929001391002	MAS LEDtube HF 1200mm HE 16.5W 830 T5	30K hingga 100K Hz	30K to 100K Hz	16,5 W	-
929001391102	MAS LEDtube HF 1200mm HE 16.5W 840 T5	30K hingga 100K Hz	30K to 100K Hz	16,5 W	-
929001391202	MAS LEDtube HF 1200mm HE 16.5W 865 T5	30K hingga 100K Hz	30K to 100K Hz	16,5 W	-

Order Code	Full Product Name	Frekuensi Input	Frekuensi Garis	Konsumsi Daya	Watt yang setara
					Setara
929001391402	MAS LEDtube HF 1500mm HE 20W 840 T5	30K hingga 100K Hz	30K to 100K Hz	20 W	-
929001391502	MAS LEDtube HF 1500mm HE 20W 865 T5	30K hingga 100K Hz	30K to 100K Hz	20 W	-
929001399508	MAS LEDtube HF 600mm HE 8W 840 T5 AP	35K hingga 70K Hz	-	8 W	14 W
929003795202	MAS LEDtube HF 600mm HE 7W 840 T5	30K hingga 100K Hz	-	7 W	-
929003795302	MAS LEDtube HF 600mm HE 7W 865 T5	30K hingga 100K Hz	-	7 W	-

### Suhu

Order Code	Full Product Name	T-Case Maksimum (Nom)
929003153902	MAS LEDtube HF 1500mm UO 36W 830 T5	75 °C
929003154002	MAS LEDtube HF 1500mm UO 36W 840 T5	75 °C
929003154102	MAS LEDtube HF 1500mm UO 36W 865 T5	75 °C
929001391002	MAS LEDtube HF 1200mm HE 16.5W 830 T5	65 °C
929001391102	MAS LEDtube HF 1200mm HE 16.5W 840 T5	65 °C
929001391202	MAS LEDtube HF 1200mm HE 16.5W 865 T5	65 °C

Order Code	Full Product Name	T-Case Maksimum (Nom)
929001391402	MAS LEDtube HF 1500mm HE 20W 840 T5	65 °C
929001391502	MAS LEDtube HF 1500mm HE 20W 865 T5	65 °C
929001399508	MAS LEDtube HF 600mm HE 8W 840 T5 AP	40 °C
929003795202	MAS LEDtube HF 600mm HE 7W 840 T5	50 °C
929003795302	MAS LEDtube HF 600mm HE 7W 865 T5	50 °C

### Kontrol dan Peredupan

# MASTER LED tube InstantFit HF T5

Order Code	Full Product Name	Dapat diredukan
929003153902	MAS LEDtube HF 1500mm UO 36W 830 T5	Ya - Periksa kompatibilitas ballast
929003154002	MAS LEDtube HF 1500mm UO 36W 840 T5	Ya - Periksa kompatibilitas ballast
929003154102	MAS LEDtube HF 1500mm UO 36W 865 T5	Ya - Periksa kompatibilitas ballast
929001391002	MAS LEDtube HF 1200mm HE 16.5W 830 T5	Ya - Periksa kompatibilitas ballast
929001391102	MAS LEDtube HF 1200mm HE 16.5W 840 T5	Ya - Periksa kompatibilitas ballast
929001391202	MAS LEDtube HF 1200mm HE 16.5W 865 T5	Ya - Periksa kompatibilitas ballast

Order Code	Full Product Name	Dapat diredukan
929001391402	MAS LEDtube HF 1500mm HE 20W 840 T5	Ya - Periksa kompatibilitas ballast
929001391502	MAS LEDtube HF 1500mm HE 20W 865 T5	Ya - Periksa kompatibilitas ballast
929001399508	MAS LEDtube HF 600mm HE 8W 840 T5 AP	Tidak
929003795202	MAS LEDtube HF 600mm HE 7W 840 T5	Ya - Periksa kompatibilitas ballast
929003795302	MAS LEDtube HF 600mm HE 7W 865 T5	Ya - Periksa kompatibilitas ballast

## Penyetujuan dan Aplikasi

Order Code	Full Product Name	Kisaran suhu ambien	Penggunaan Energi kWh/1000 h
929003153902	MAS LEDtube HF 1500mm UO 36W 830 T5	-20 °C hingga 45 °C	36 kWh
929003154002	MAS LEDtube HF 1500mm UO 36W 840 T5	-20 °C hingga 45 °C	36 kWh
929003154102	MAS LEDtube HF 1500mm UO 36W 865 T5	-20 °C hingga 45 °C	36 kWh
929001391002	MAS LEDtube HF 1200mm HE 16.5W 830 T5	-20 °C hingga 45 °C	17 kWh
929001391102	MAS LEDtube HF 1200mm HE 16.5W 840 T5	-20 °C hingga 45 °C	17 kWh
929001391202	MAS LEDtube HF 1200mm HE 16.5W 865 T5	-20 °C hingga 45 °C	17 kWh
929001391402	MAS LEDtube HF 1500mm HE 20W 840 T5	-20 °C hingga 45 °C	20 kWh
929001391502	MAS LEDtube HF 1500mm HE 20W 865 T5	-20 °C hingga 45 °C	20 kWh
929001399508	MAS LEDtube HF 600mm HE 8W 840 T5 AP	-20 hingga +45 °C	10 kWh
929003795202	MAS LEDtube HF 600mm HE 7W 840 T5	-20 hingga +45 °C	7 kWh
929003795302	MAS LEDtube HF 600mm HE 7W 865 T5	-20 hingga +45 °C	7 kWh

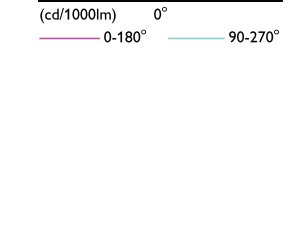
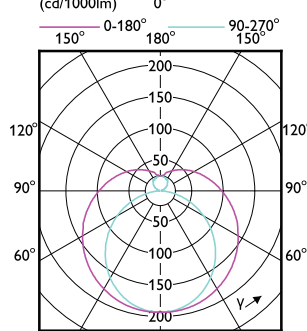
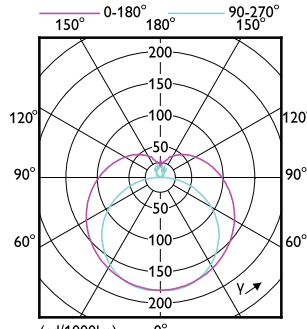
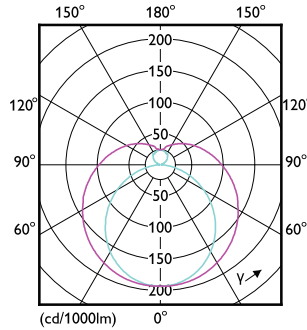
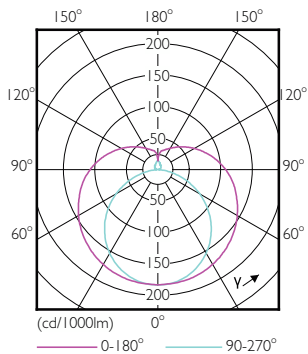

# MASTER LED tube InstantFit HF T5

