



GentleSpace: iluminación eficiente y de alta calidad diseñada para la excelencia en entornos difíciles

GentleSpace gen4

GentleSpace gen4 es la solución de iluminación definitiva para entornos industriales e instalaciones deportivas cubiertas. Supera las expectativas, ya que garantiza una calidad de luz superior, mejora la seguridad y la productividad de los empleados y cumple con todas las regulaciones de seguridad pertinentes. GentleSpace gen4 se ha diseñado para durar y reduce la frecuencia, las molestias y los costes de mantenimiento, por lo que es la opción ideal para instalaciones en techos altos. Su diseño energéticamente eficiente reduce los gastos operativos, ofreciendo la máxima eficiencia de aplicación y un atractivo coste total de propiedad (TCO). Esta gama de productos ofrece una amplia variedad de ópticas, aberturas de haz (de muy estrecho a ancho y una óptica especial para pasillos altos y estrechos), paquetes lumínicos y opciones de conectividad. Con GentleSpace gen4 es fácil crear una solución de iluminación a medida para aplicaciones en techos altos. Su diseño moderno y plano hace que sea más fácil de instalar, limpiar y mantener. El diseño de ventana óptica única proporciona un rendimiento visual superior. Una variedad de posibilidades de montaje y conectores, como el conector IP65 premontado, permiten una instalación rápida y fácil. Su diseño sólido permite soportar condiciones adversas en todo tipo de ambientes. Puedes elegir entre varios materiales de cierre, incluidas variantes especializadas para temperaturas extremas (XT), ambientes explosivos (ATEX 2/22) y aplicaciones deportivas. Además, GentleSpace gen4 dispone de opciones de conectividad avanzada. Está listo para

GentleSpace gen4

usarse en sistemas de iluminación conectada como Interact. Iluminación fiable y de alta eficiencia con conectividad inteligente: una opción brillante para un futuro mejor. Adopta la sostenibilidad con GentleSpace gen4, la solución de iluminación de gran altura que cumple con los principios de la economía circular al priorizar la durabilidad y la reciclabilidad. La luminaria es fácil de mantener y toda la información está disponible al alcance de la mano, a través de la aplicación QR de Signify Service Tag. Tanto si busca una solución fiable de "instalo y olvido" como una que pueda adaptarse y controlarse después de la instalación, GentleSpace gen4 es la opción correcta para usted.

Beneficios

- Diseño Robusto, creado para soportar condiciones adversas en todo tipo de entornos
- Arquitectura de producto compacta, resistente a impactos elevados (IK08), agua y polvo (IP65)
- Excelente uniformidad de luz y bajo deslumbramiento para optimizar las condiciones de trabajo con mayor seguridad y mayor confort visual
- Atractivo coste total de propiedad gracias a su alta eficacia lumínica (hasta 192 lm/W), su larga vida útil (100.000 horas L85) y el plan de iluminación optimizada, que requiere menos luminarias por aplicación
- Fácil instalación. Arquitectura ligera de una sola pieza (aproximadamente un 20 % más ligera que la generación anterior) con múltiples opciones de montaje para una instalación flexible en diversos entornos y condiciones
- Conectividad Interact Ready para una iluminación inteligente
- Conéctate a la nube y descubre otras formas de ahorrar energía mediante una eficiencia optimizada, la detección de movimiento y el aprovechamiento de la luz natural, así como mejoras en la gestión de la iluminación, la productividad y la seguridad
- Diseñado pensando en sostenibilidad. Cumple con los criterios de circularidad en iluminación para alcanzar tus objetivos de sostenibilidad fácilmente

Características

- Rendimiento excepcional, con versiones Ultra Efficient (UE, 189 lm/W) y High-Efficiency (HE, 183 lm/W)
- Larga vida útil de 100 000 horas L85
- Protección contra entrada de polvo y agua (IP65) y protección contra impactos (IK08)
- Amplia variedad de ópticas (haz amplio, haz medio, haz estrecho, haz extraestrecho, para estanterías altas, asimétrica)
- Opciones especiales para una amplia variedad de aplicaciones: versión Xtreme (XT) hasta 70 °C, clase I o II, versión especial para piscinas de interior (SWP), protección marina (MSP), opción a prueba de balonazos (BP) con certificación VDE, versión certificada ATEX 2/22
- Sistema de montaje extraíble para facilitar la instalación, con diferentes opciones y conectores de montaje (conector premontado IP65 o free wire)
- Robusta carcasa de aluminio fundido a presión con gestión térmica eficiente y diseño liso delantero y trasero para facilitar la instalación, la limpieza y el mantenimiento
- Acceso a la aplicación de Signify Service tag con información de servicio y mantenimiento
- Probada contra una amplia lista de sustancias químicas que pueden estar presentes en entornos industriales

GentleSpace gen4

Aplicaciones

- Plantas de fabricación (desde alimentos y bebidas hasta industria pesada)
- Almacenes y centros de logística
- Instalaciones deportivas cubiertas, piscinas y salas de exposiciones

Versions

GentleSpace gen4-large, suspension



GentleSpace gen4-large, bracket, Interact ready



GentleSpace gen4-small, bracket



GentleSpace gen4, Interact Ready



Plano de dimensiones

BY580X suspended

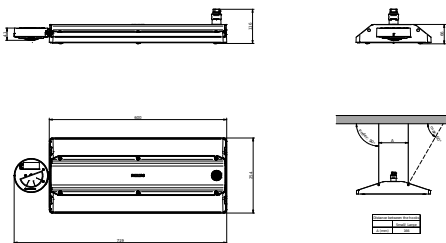

700s suspended

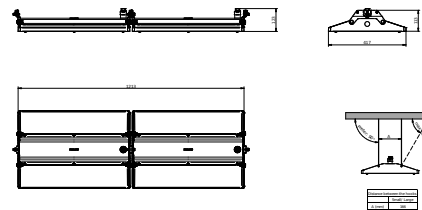

With Wieland connector on a cable or free cable finish, cable length is: 0.5m or 1m or 1.5m or 2m

With Wieland connector on a cable or free cable finish, cable length is: 0.5m or 1m or 1.5m or 2m

Plano de dimensiones

BY581X suspended

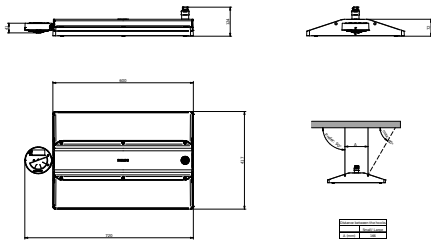

With Wieland connector on a cable or free cable finish, cable length is: 0.5m or 1m or 1.5m, or 2m

BY580P, BY582P suspended

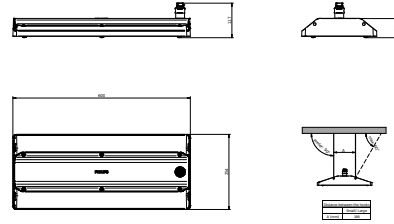

With Wieland connector on a cable or free cable finish, cable length is: 0.5m or 1m or 1.5m, or 2m

BY581P, BY583P Bracket

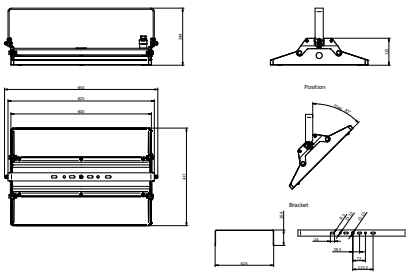

With Wieland connector on a cable or free cable finish, cable length is: 0.5m or 1m or 1.5m, or 2m

BY580P, BY582P Wallmounted bracket

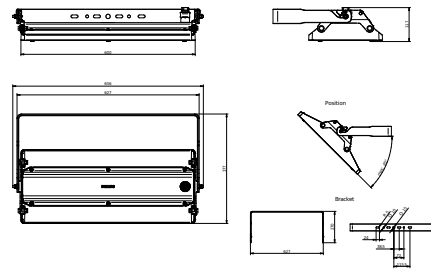

With Wieland connector on a cable or free cable finish, cable length is: 0.5m or 1m or 1.5m, or 2m

BY580P, BY582P Bracket

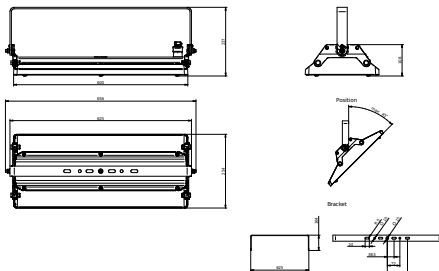

With Wieland connector on a cable or free cable finish, cable length is: 0.5m or 1m or 1.5m, or 2m

BY581X Bracket

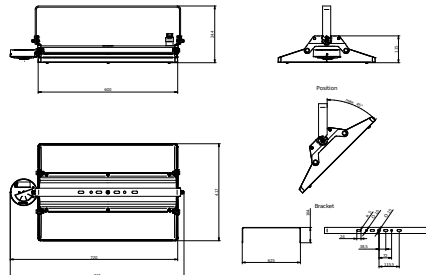

With Wieland connector on a cable or free cable finish, cable length is: 0.5m or 1m or 1.5m, or 2m

BY580X Bracket

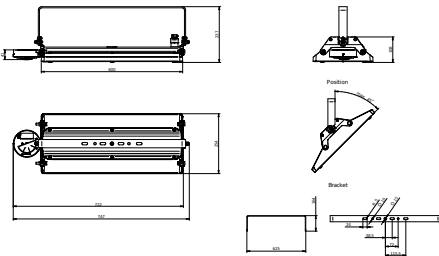

With Wieland connector on a cable or free cable finish, cable length is: 0.5m or 1m or 1.5m, or 2m

BY581P, BY583P Wallmounted bracket

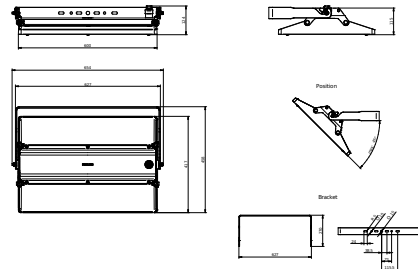

With Wieland connector on a cable or free cable finish, cable length is: 0.5m or 1m or 1.5m, or 2m

Plano de dimensiones

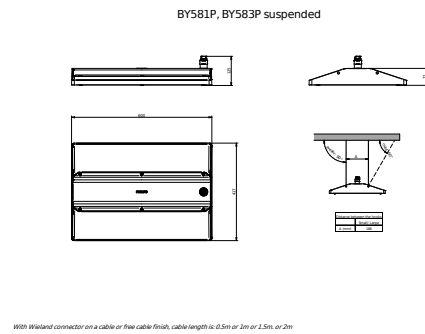
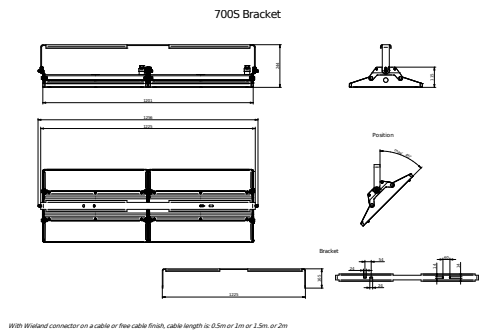

Detalles del producto

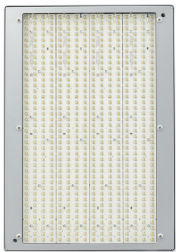

GentleSpace gen4-large,
suspension

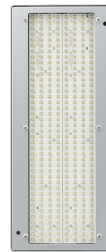

GentleSpace gen4-small,
suspension

Información general

Driver incluido	Sí
Número de unidades de equipo	1 unidad

Operativos y eléctricos

Clase de protección IEC	Seguridad clase I
Tensión de entrada	220 a 240 V
Line Frequency	50 to 60 Hz

Mecánicos y de carcasa

Color de la carcasa	Plata
Código de protección de entrada	IP65

Funcionamiento de emergencia

Emergencia centralizada	No
-------------------------	----

Aprobación y aplicación

Marca CE	Sí
Certificado ENEC	Certificado ENEC
Marca de inflamabilidad	Para su montaje en superficies fácilmente inflamables

Rendimiento inicial (conforme con IEC)

Tolerancia de flujo luminoso	+/-10%
------------------------------	--------

Información general

Order Code	Full Product Name	Service tag
58949000	BY581P 700S/840 DIA WB GC SI	Sí
58950600	BY581P 700S/840 DIA HE WB GC SI	Sí
58951300	BY581P 700S/840 DIA WB GC SI BR	Sí
58952000	BY581P 700S/840 DIA HE WB GC SI BR	Sí
59401200	BY581X 250S/840 SIA WB GC SI H4 BR	Sí
59402900	BY581X 250S/840 SIA HE WB GC SI H4 BR	Sí
59394700	BY581X 250S/840 SIA WB GC SI H4	Sí
59395400	BY581X 350S/840 SIA WB GC SI H4	Sí
59398500	BY581X 250S/840 SIA HE WB GC SI H4	Sí
59399200	BY581X 350S/840 SIA HE WB GC SI H4	Sí
59404300	BY581X 250S/840 SIA WB GC SI ELP3 H4	Sí
59405000	BY581X 250S/840 SIA WB GC SI ELW3 H4	Sí
59406700	BY581X 250S/840 SIA HE WB GC SI ELP3 H4	Sí
59407400	BY581X 250S/840 SIA HE WB GC SI ELW3 H4	Sí
59400500	BY580X 170S/840 SIA WB GC SI H4 BR	Sí
59403600	BY580X 170S/840 SIA HE WB GC SI H4 BR	Sí
59408100	BY580P 170S/840 PSU WB GC SI	Sí
59410400	BY580P 170S/840 PSU HE WB GC SI	Sí
59412800	BY580P 100S/840 DIA UE WB GC SI	-
59414200	BY580P 130S/840 DIA WB GC SI	Sí
59415900	BY580P 170S/840 DIA WB GC SI	Sí
59418000	BY580P 130S/840 DIA HE WB GC SI	Sí
59419700	BY580P 170S/840 DIA HE WB GC SI	Sí
59422700	BY580P 170S/840 DIA WB PC SI	Sí
59426500	BY580P 170S/840 DIA HE WB PC SI	Sí
59430200	BY580P 170S/840 DIA WB GC SI ELP3	Sí
59432600	BY580P 170S/840 DIA HE WB GC SI ELP3	Sí
59434000	BY580P 130S/840 DIA MB GC SI	Sí
59435700	BY580P 170S/840 DIA MB GC SI	Sí
59438800	BY580P 130S/840 DIA HE MB GC SI	Sí
59439500	BY580P 170S/840 DIA HE MB GC SI	Sí
58908700	BY580P 170S/840 DIA NB GC SI	Sí
58910000	BY580P 170S/840 DIA HE NB GC SI	Sí
58912400	BY580P 170S/840 DIA XNB GC SI	-
58914800	BY580P 170S/840 DIA HE XNB GC SI	-
58916200	BY580P 170S/840 DIA HRO GC SI	Sí
58918600	BY580P 170S/840 DIA HE HRO GC SI	Sí
58920900	BY580P 170S/865 DIA WB GC SI	Sí
58922300	BY580P 170S/865 DIA HE WB GC SI	Sí
58924700	BY580P 170S/830 DIA WB GC SI	Sí
58926100	BY580P 170S/830 DIA HE WB GC SI	Sí
58928500	BY580P 170S/940 DIA WB GC SI	Sí
59036600	BY582P 170S/840 DIA HE WB GC SI 0.5m CW5	-
59038000	BY582P 170S/840 DIA HE WB GC SI 1m CW5	-
58904900	BY580P 170S/840 DIA ASYM GC SI MBW	-
58906300	BY580P 170S/840 DIA HE ASYM GC SI MBW	-
59425800	BY581P 250S/840 DIA WB GC SI BR	Sí
59429600	BY581P 250S/840 DIA HE WB GC SI BR	Sí
58901800	BY581P 250S/840 DIA ASYM GC SI BR	-
58903200	BY581P 250S/840 DIA HE ASYM GC SI BR	-
58905600	BY581P 250S/840 DIA ASYM GC SI MBW	-

Order Code	Full Product Name	Service tag
58907000	BY581P 250S/840 DIA HE ASYM GC SI MBW	-
58932200	BY581P 350S/840 DIA HE WB GC SI BR XT 1m	-
59424100	BY580P 170S/840 DIA WB GC SI BR	Sí
59428900	BY580P 170S/840 DIA HE WB GC SI BR	Sí
58902500	BY580P 170S/840 DIA HE ASYM GC SI BR	-
59409800	BY581P 250S/840 PSU WB GC SI	Sí
59411100	BY581P 250S/840 PSU HE WB GC SI	Sí
59413500	BY581P 200S/840 DIA UE WB GC SI	-
59416600	BY581P 250S/840 DIA WB GC SI	Sí
59417300	BY581P 350S/840 DIA WB GC SI	Sí
59420300	BY581P 250S/840 DIA HE WB GC SI	Sí
59421000	BY581P 350S/840 DIA HE WB GC SI	Sí
59423400	BY581P 250S/840 DIA WB PC SI	Sí
59427200	BY581P 250S/840 DIA HE WB PC SI	Sí
59431900	BY581P 250S/840 DIA WB GC SI ELD3	Sí
59433300	BY581P 250S/840 DIA HE WB GC SI ELD3	Sí
59436400	BY581P 250S/840 DIA MB GC SI	Sí
59437100	BY581P 350S/840 DIA MB GC SI	Sí
59440100	BY581P 250S/840 DIA HE MB GC SI	Sí
59441800	BY581P 350S/840 DIA HE MB GC SI	Sí
58909400	BY581P 250S/840 DIA NB GC SI	Sí
58911700	BY581P 250S/840 DIA HE NB GC SI	Sí
58913100	BY581P 250S/840 DIA XNB GC SI	-
58915500	BY581P 250S/840 DIA HE XNB GC SI	-
58917900	BY581P 250S/840 DIA HRO GC SI	Sí
58919300	BY581P 250S/840 DIA HE HRO GC SI	Sí
58921600	BY581P 250S/865 DIA WB GC SI	Sí
58923000	BY581P 250S/865 DIA HE WB GC SI	Sí
58925400	BY581P 250S/830 DIA WB GC SI	Sí
58927800	BY581P 250S/830 DIA HE WB GC SI	Sí
58929200	BY581P 250S/940 DIA WB GC SI	Sí
58930800	BY581P 250S/840 DIA HE WB GC SI XT 1m	-
58931500	BY581P 350S/840 DIA HE WB GC SI XT 1m	-
59037300	BY583P 250S/840 DIA HE WB GC SI 0.5m CW5	-
59039700	BY583P 250S/840 DIA HE WB GC SI 1m CW5	-
59392300	BY580X 130S/840 SIA WB GC SI H4	Sí
59393000	BY580X 170S/840 SIA WB GC SI H4	Sí
59396100	BY580X 130S/840 SIA HE WB GC SI H4	Sí
59397800	BY580X 170S/840 SIA HE WB GC SI H4	Sí

Datos técnicos de la luz (1/2)

Order Code	Full Product Name	Ángulo del haz de luz	Temperatura de color correlacionada (nom.)	Índice de reproducción cromática (IRC)	Eficacia lumínica (nominal)

Order Code	Full Product Name	Ángulo del haz de luz	Temperatura de color correlacionada (nom.)	Índice de reproducción cromática (IRC)	Eficacia lumínica (nominal)

GentleSpace gen4

Order Code	Full Product Name	Ángulo del haz de fuente de luz	Temperatura de color correlacionada (nom.)	Índice de reproducción cromática (IRC)	Eficacia lumínica (nominal) (nom.)
58951300	BY581P 700S/840 DIA WB GC SI BR	-	4000 K	>80	167 lm/W
58952000	BY581P 700S/840 DIA HE WB GC SI BR	-	4000 K	>80	177 lm/W
59401200	BY581X 250S/840 SIA WB GC SI H4 BR	-	4000 K	>80	174 lm/W
59402900	BY581X 250S/840 SIA HE WB GC SI H4 BR	-	4000 K	>80	184 lm/W
59394700	BY581X 250S/840 SIA WB GC SI H4	-	4000 K	>80	174 lm/W
59395400	BY581X 350S/840 SIA WB GC SI H4	-	4000 K	>80	167 lm/W
59398500	BY581X 250S/840 SIA HE WB GC SI H4	-	4000 K	>80	184 lm/W
59399200	BY581X 350S/840 SIA HE WB GC SI H4	-	4000 K	>80	177 lm/W
59404300	BY581X 250S/840 SIA WB GC SI ELP3 H4	-	4000 K	>80	174 lm/W
59405000	BY581X 250S/840 SIA WB GC SI ELW3 H4	-	4000 K	>80	174 lm/W
59406700	BY581X 250S/840 SIA HE WB GC SI ELP3 H4	-	4000 K	>80	184 lm/W
59407400	BY581X 250S/840 SIA HE WB GC SI ELW3 H4	-	4000 K	>80	184 lm/W
59400500	BY580X 170S/840 SIA WB GC SI H4 BR	-	4000 K	>80	167 lm/W
59403600	BY580X 170S/840 SIA HE WB GC SI H4 BR	-	4000 K	>80	175 lm/W

Order Code	Full Product Name	Ángulo del haz de fuente de luz	Temperatura de color correlacionada (nom.)	Índice de reproducción cromática (IRC)	Eficacia lumínica (nominal) (nom.)
59408100	BY580P 170S/840 PSU WB GC SI	-	4000 K	>80	167 lm/W
59410400	BY580P 170S/840 PSU HE WB GC SI	-	4000 K	>80	175 lm/W
59412800	BY580P 100S/840 DIA UE WB GC SI	-	4000 K	>80	182 lm/W
59414200	BY580P 130S/840 DIA WB GC SI	-	4000 K	>80	171 lm/W
59415900	BY580P 170S/840 DIA WB GC SI	-	4000 K	>80	167 lm/W
59418000	BY580P 130S/840 DIA HE WB GC SI	-	4000 K	>80	178 lm/W
59419700	BY580P 170S/840 DIA HE WB GC SI	-	4000 K	>80	175 lm/W
59422700	BY580P 170S/840 DIA WB PC SI	-	4000 K	>80	155 lm/W
59426500	BY580P 170S/840 DIA HE WB PC SI	-	4000 K	>80	164 lm/W
59430200	BY580P 170S/840 DIA WB GC SI ELP3	-	4000 K	>80	167 lm/W
59432600	BY580P 170S/840 DIA HE WB GC SI ELP3	-	4000 K	>80	175 lm/W
59434000	BY580P 130S/840 DIA MB GC SI	-	4000 K	>80	169 lm/W
59435700	BY580P 170S/840 DIA MB GC SI	-	4000 K	>80	164 lm/W
59438800	BY580P 130S/840 DIA HE MB GC SI	-	4000 K	>80	178 lm/W
59439500	BY580P 170S/840 DIA HE MB GC SI	-	4000 K	>80	174 lm/W

GentleSpace gen4

Order Code	Full Product Name	Ángulo del haz de luz (°)	Temperatura de color correlacionada (nom.)	Índice de reproducción cromática (IRC)	Eficacia lumínica (nominal) (lm/W)
58908700	BY580P 170S/840 DIA NB GC SI	10 or 24	4000 K	>80	164 lm/W
58910000	BY580P 170S/840 DIA HE NB GC SI	10 or 24	4000 K	>80	174 lm/W
58912400	BY580P 170S/840 DIA XNB GC SI	-	4000 K	>80	164 lm/W
58914800	BY580P 170S/840 DIA HE XNB GC SI	-	4000 K	>80	174 lm/W
58916200	BY580P 170S/840 DIA HRO GC SI	-	4000 K	>80	164 lm/W
58918600	BY580P 170S/840 DIA HE HRO GC SI	-	4000 K	>80	174 lm/W
58920900	BY580P 170S/865 DIA WB GC SI	-	6500 K	>80	164 lm/W
58922300	BY580P 170S/865 DIA HE WB GC SI	-	6500 K	>80	172 lm/W
58924700	BY580P 170S/830 DIA WB GC SI	-	3000 K	>80	155 lm/W
58926100	BY580P 170S/830 DIA HE WB GC SI	-	3000 K	>80	159 lm/W
58928500	BY580P 170S/940 DIA WB GC SI	-	4000 K	>90	157 lm/W
59036600	BY582P 170S/840 DIA HE WB GC SI 0.5m CW5	-	4000 K	>80	167 lm/W
59038000	BY582P 170S/840 DIA HE WB GC SI 1m CW5	-	4000 K	>80	167 lm/W
58904900	BY580P 170S/840 DIA ASYM GC SI MBW	-	4000 K	>80	157 lm/W
58906300	BY580P 170S/840 DIA	-	4000 K	>80	170 lm/W

Order Code	Full Product Name	Ángulo del haz de luz (°)	Temperatura de color correlacionada (nom.)	Índice de reproducción cromática (IRC)	Eficacia lumínica (nominal) (lm/W)
	HE ASYM GC SI MBW				
59425800	BY581P 250S/840 DIA WB GC SI BR	-	4000 K	>80	174 lm/W
59429600	BY581P 250S/840 DIA HE WB GC SI BR	-	4000 K	>80	181 lm/W
58901800	BY581P 250S/840 DIA ASYM GC SI BR	-	4000 K	>80	165 lm/W
58903200	BY581P 250S/840 DIA HE ASYM GC SI BR	-	4000 K	>80	176 lm/W
58905600	BY581P 250S/840 DIA ASYM GC SI MBW	-	4000 K	>80	165 lm/W
58907000	BY581P 250S/840 DIA HE ASYM GC SI MBW	-	4000 K	>80	176 lm/W
58932200	BY581P 350S/840 DIA HE WB GC SI BR XT 1m	-	4000 K	>80	177 lm/W
59424100	BY580P 170S/840 DIA WB GC SI BR	-	4000 K	>80	167 lm/W
59428900	BY580P 170S/840 DIA HE WB GC SI BR	-	4000 K	>80	175 lm/W
58902500	BY580P 170S/840 DIA HE ASYM GC SI BR	-	4000 K	>80	170 lm/W
59409800	BY581P 250S/840 PSU WB GC SI	-	4000 K	>80	174 lm/W
59411100	BY581P 250S/840 PSU HE WB GC SI	-	4000 K	>80	184 lm/W
59413500	BY581P 200S/840 DIA UE WB GC SI	-	4000 K	>80	189 lm/W

GentleSpace gen4

Order Code	Full Product Name	Ángulo del haz de luz	Temperatura de color correlacionada (nom.)	Índice de reproducción cromática (IRC)	Eficacia lumínica (nominal)
59416600	BY581P 250S/840 DIA WB GC SI	-	4000 K	>80	174 lm/W
59417300	BY581P 350S/840 DIA WB GC SI	-	4000 K	>80	167 lm/W
59420300	BY581P 250S/840 DIA HE WB GC SI	-	4000 K	>80	181 lm/W
59421000	BY581P 350S/840 DIA HE WB GC SI	-	4000 K	>80	177 lm/W
59423400	BY581P 250S/840 DIA WB PC SI	-	4000 K	>80	162 lm/W
59427200	BY581P 250S/840 DIA HE WB PC SI	-	4000 K	>80	171 lm/W
59431900	BY581P 250S/840 DIA WB GC SI ELD3	-	4000 K	>80	174 lm/W
59433300	BY581P 250S/840 DIA HE WB GC SI ELD3	-	4000 K	>80	181 lm/W
59436400	BY581P 250S/840 DIA MB GC SI	-	4000 K	>80	171 lm/W
59437100	BY581P 350S/840 DIA MB GC SI	-	4000 K	>80	167 lm/W
59440100	BY581P 250S/840 DIA HE MB GC SI	-	4000 K	>80	181 lm/W
59441800	BY581P 350S/840 DIA HE MB GC SI	-	4000 K	>80	175 lm/W
58909400	BY581P 250S/840 DIA NB GC SI	10 or 24 °	4000 K	>80	171 lm/W
58911700	BY581P 250S/840 DIA HE NB GC SI	10 or 24 °	4000 K	>80	181 lm/W
58913100	BY581P 250S/840 DIA XNB GC SI	-	4000 K	>80	171 lm/W
58915500	BY581P 250S/840 DIA HE XNB GC SI	-	4000 K	>80	181 lm/W

Order Code	Full Product Name	Ángulo del haz de luz	Temperatura de color correlacionada (nom.)	Índice de reproducción cromática (IRC)	Eficacia lumínica (nominal)
58917900	BY581P 250S/840 DIA HRO GC SI	-	4000 K	>80	171 lm/W
58919300	BY581P 250S/840 DIA HE HRO GC SI	-	4000 K	>80	181 lm/W
58921600	BY581P 250S/865 DIA WB GC SI	-	6500 K	>80	171 lm/W
58923000	BY581P 250S/865 DIA HE WB GC SI	-	6500 K	>80	179 lm/W
58925400	BY581P 250S/830 DIA WB GC SI	-	3000 K	>80	162 lm/W
58927800	BY581P 250S/830 DIA HE WB GC SI	-	3000 K	>80	171 lm/W
58929200	BY581P 250S/940 DIA WB GC SI	-	4000 K	>90	165 lm/W
58930800	BY581P 250S/840 DIA HE WB GC SI XT 1m	-	4000 K	>80	181 lm/W
58931500	BY581P 350S/840 DIA HE WB GC SI XT 1m	-	4000 K	>80	177 lm/W
59037300	BY583P 250S/840 DIA HE WB GC SI 0.5m CW5	-	4000 K	>80	174 lm/W
59039700	BY583P 250S/840 DIA HE WB GC SI 1m CW5	-	4000 K	>80	174 lm/W
59392300	BY580X 130S/840 SIA WB GC SI H4	-	4000 K	>80	171 lm/W
59393000	BY580X 170S/840 SIA WB GC SI H4	-	4000 K	>80	167 lm/W
59396100	BY580X 130S/840 SIA HE WB GC SI H4	-	4000 K	>80	178 lm/W

Order Code	Full Product Name	Ángulo	Temperatura de	Índice de	Eficacia
		del haz de fuente de luz	color correlacionada (nom.)	reproducción cromática (IRC)	luminica (nominal) (nom.)
59397800	BY580X 170S/840 SIA HE WB GC SI H4	-	4000 K	>80	175 lm/W

Datos técnicos de la luz (2/2)

Order Code	Full Product Name	Flujo luminoso	Tipo de óptica
58949000	BY581P 700S/840 DIA WB GC SI	70.000 lm	Haz ancho
58950600	BY581P 700S/840 DIA HE WB GC SI	70.000 lm	Haz ancho
58951300	BY581P 700S/840 DIA WB GC SI BR	70.000 lm	Haz ancho
58952000	BY581P 700S/840 DIA HE WB GC SI BR	70.000 lm	Haz ancho
59401200	BY581X 250S/840 SIA WB GC SI H4 BR	25.000 lm	Haz ancho
59402900	BY581X 250S/840 SIA HE WB GC SI H4 BR	25.000 lm	Haz ancho
59394700	BY581X 250S/840 SIA WB GC SI H4	25.000 lm	Haz ancho
59395400	BY581X 350S/840 SIA WB GC SI H4	35.000 lm	Haz ancho
59398500	BY581X 250S/840 SIA HE WB GC SI H4	25.000 lm	Haz ancho
59399200	BY581X 350S/840 SIA HE WB GC SI H4	35.000 lm	Haz ancho
59404300	BY581X 250S/840 SIA WB GC SI ELP3 H4	25.000 lm	Haz ancho
59405000	BY581X 250S/840 SIA WB GC SI ELW3 H4	25.000 lm	Haz ancho
59406700	BY581X 250S/840 SIA HE WB GC SI ELP3 H4	25.000 lm	Haz ancho
59407400	BY581X 250S/840 SIA HE WB GC SI ELW3 H4	25.000 lm	Haz ancho
59400500	BY580X 170S/840 SIA WB GC SI H4 BR	17.000 lm	Haz ancho
59403600	BY580X 170S/840 SIA HE WB GC SI H4 BR	17.000 lm	Haz ancho
59408100	BY580P 170S/840 PSU WB GC SI	17.000 lm	Haz ancho
59410400	BY580P 170S/840 PSU HE WB GC SI	17.000 lm	Haz ancho
59412800	BY580P 100S/840 DIA UE WB GC SI	10.000 lm	Haz ancho
59414200	BY580P 130S/840 DIA WB GC SI	13.000 lm	Haz ancho
59415900	BY580P 170S/840 DIA WB GC SI	17.000 lm	Haz ancho
59418000	BY580P 130S/840 DIA HE WB GC SI	13.000 lm	Haz ancho
59419700	BY580P 170S/840 DIA HE WB GC SI	17.000 lm	Haz ancho
59422700	BY580P 170S/840 DIA WB PC SI	17.000 lm	Haz ancho
59426500	BY580P 170S/840 DIA HE WB PC SI	17.000 lm	Haz ancho
59430200	BY580P 170S/840 DIA WB GC SI ELP3	17.000 lm	Haz ancho
59432600	BY580P 170S/840 DIA HE WB GC SI ELP3	17.000 lm	Haz ancho
59434000	BY580P 130S/840 DIA MB GC SI	13.000 lm	Haz medio
59435700	BY580P 170S/840 DIA MB GC SI	17.000 lm	Haz medio

Order Code	Full Product Name	Flujo luminoso	Tipo de óptica
59438800	BY580P 130S/840 DIA HE MB GC SI	13.000 lm	Haz medio
59439500	BY580P 170S/840 DIA HE MB GC SI	17.000 lm	Haz medio
58908700	BY580P 170S/840 DIA NB GC SI	17.000 lm	Haz estrecho
58910000	BY580P 170S/840 DIA HE NB GC SI	17.000 lm	Haz estrecho
58912400	BY580P 170S/840 DIA XNB GC SI	17.000 lm	Haz estrecho
58914800	BY580P 170S/840 DIA HE XNB GC SI	17.000 lm	Haz estrecho
58916200	BY580P 170S/840 DIA HRO GC SI	17.000 lm	Óptica para estanterías altas
58918600	BY580P 170S/840 DIA HE HRO GC SI	17.000 lm	Óptica para estanterías altas
58920900	BY580P 170S/865 DIA WB GC SI	17.000 lm	Haz ancho
58922300	BY580P 170S/865 DIA HE WB GC SI	17.000 lm	Haz ancho
58924700	BY580P 170S/830 DIA WB GC SI	17.000 lm	Haz ancho
58926100	BY580P 170S/830 DIA HE WB GC SI	17.000 lm	Haz ancho
58928500	BY580P 170S/940 DIA WB GC SI	17.000 lm	Haz ancho
59036600	BY582P 170S/840 DIA HE WB GC SI 0.5m CW5	17.000 lm	Haz ancho
59038000	BY582P 170S/840 DIA HE WB GC SI 1m CW5	17.000 lm	Haz ancho
58904900	BY580P 170S/840 DIA ASYM GC SI MBW	17.000 lm	Ángulo de haz asimétrico
58906300	BY580P 170S/840 DIA HE ASYM GC SI MBW	17.000 lm	Ángulo de haz asimétrico
59425800	BY581P 250S/840 DIA WB GC SI BR	25.000 lm	Haz ancho
59429600	BY581P 250S/840 DIA HE WB GC SI BR	25.000 lm	Haz ancho
58901800	BY581P 250S/840 DIA ASYM GC SI BR	25.000 lm	Ángulo de haz asimétrico
58903200	BY581P 250S/840 DIA HE ASYM GC SI BR	25.000 lm	Ángulo de haz asimétrico
58905600	BY581P 250S/840 DIA ASYM GC SI MBW	25.000 lm	Ángulo de haz asimétrico
58907000	BY581P 250S/840 DIA HE ASYM GC SI MBW	25.000 lm	Ángulo de haz asimétrico
58932200	BY581P 350S/840 DIA HE WB GC SI BR XT 1m	35.000 lm	Haz ancho
59424100	BY580P 170S/840 DIA WB GC SI BR	17.000 lm	Haz ancho
59428900	BY580P 170S/840 DIA HE WB GC SI BR	17.000 lm	Haz ancho
58902500	BY580P 170S/840 DIA HE ASYM GC SI BR	17.000 lm	Ángulo de haz asimétrico

Order Code	Full Product Name	Flujo luminoso	Tipo de óptica
59409800	BY581P 250S/840 PSU WB GC SI	25.000 lm	Haz ancho
59411100	BY581P 250S/840 PSU HE WB GC SI	25.000 lm	Haz ancho
59413500	BY581P 200S/840 DIA UE WB GC SI	20.000 lm	Haz ancho
59416600	BY581P 250S/840 DIA WB GC SI	25.000 lm	Haz ancho
59417300	BY581P 350S/840 DIA WB GC SI	35.000 lm	Haz ancho
59420300	BY581P 250S/840 DIA HE WB GC SI	25.000 lm	Haz ancho
59421000	BY581P 350S/840 DIA HE WB GC SI	35.000 lm	Haz ancho
59423400	BY581P 250S/840 DIA WB PC SI	25.000 lm	Haz ancho
59427200	BY581P 250S/840 DIA HE WB PC SI	25.000 lm	Haz ancho
59431900	BY581P 250S/840 DIA WB GC SI ELD3	25.000 lm	Haz ancho
59433300	BY581P 250S/840 DIA HE WB GC SI ELD3	25.000 lm	Haz ancho
59436400	BY581P 250S/840 DIA MB GC SI	25.000 lm	Haz medio
59437100	BY581P 350S/840 DIA MB GC SI	35.000 lm	Haz medio
59440100	BY581P 250S/840 DIA HE MB GC SI	25.000 lm	Haz medio
59441800	BY581P 350S/840 DIA HE MB GC SI	35.000 lm	Haz medio
58909400	BY581P 250S/840 DIA NB GC SI	25.000 lm	Haz estrecho
58911700	BY581P 250S/840 DIA HE NB GC SI	25.000 lm	Haz estrecho
58913100	BY581P 250S/840 DIA XNB GC SI	25.000 lm	Haz estrecho
58915500	BY581P 250S/840 DIA HE XNB GC SI	25.000 lm	Haz estrecho
58917900	BY581P 250S/840 DIA HRO GC SI	25.000 lm	Óptica para estanterías altas

Order Code	Full Product Name	Flujo luminoso	Tipo de óptica
58919300	BY581P 250S/840 DIA HE HRO GC SI	25.000 lm	Óptica para estanterías altas
58921600	BY581P 250S/865 DIA WB GC SI	25.000 lm	Haz ancho
58923000	BY581P 250S/865 DIA HE WB GC SI	25.000 lm	Haz ancho
58925400	BY581P 250S/830 DIA WB GC SI	25.000 lm	Haz ancho
58927800	BY581P 250S/830 DIA HE WB GC SI	25.000 lm	Haz ancho
58929200	BY581P 250S/940 DIA WB GC SI	25.000 lm	Haz ancho
58930800	BY581P 250S/840 DIA HE WB GC SI XT 1m	25.000 lm	Haz ancho
58931500	BY581P 350S/840 DIA HE WB GC SI XT 1m	35.000 lm	Haz ancho
59037300	BY583P 250S/840 DIA HE WB GC SI 0.5m CW5	25.000 lm	Haz ancho
59039700	BY583P 250S/840 DIA HE WB GC SI 1m CW5	25.000 lm	Haz ancho
59392300	BY580X 130S/840 SIA WB GC SI H4	13.000 lm	Haz ancho
59393000	BY580X 170S/840 SIA WB GC SI H4	17.000 lm	Haz ancho
59396100	BY580X 130S/840 SIA HE WB GC SI H4	13.000 lm	Haz ancho
59397800	BY580X 170S/840 SIA HE WB GC SI H4	17.000 lm	Haz ancho

Operativos y eléctricos

Order Code	Full Product Name	Consumo de energía	Adecuado para conmutación aleatoria
58949000	BY581P 700S/840 DIA WB GC SI	420 W	No
58950600	BY581P 700S/840 DIA HE WB GC SI	397 W	No
58951300	BY581P 700S/840 DIA WB GC SI BR	420 W	No
58952000	BY581P 700S/840 DIA HE WB GC SI BR	397 W	No
59401200	BY581X 250S/840 SIA WB GC SI H4 BR	144 W	Sí (se relaciona con la detección de presencia/ movimiento y aprovechamiento de la luz del día)
59402900	BY581X 250S/840 SIA HE WB GC SI H4 BR	136 W	Sí (se relaciona con la detección de presencia/ movimiento y aprovechamiento de la luz del día)
59394700	BY581X 250S/840 SIA WB GC SI H4	144 W	Sí (se relaciona con la detección de presencia/ movimiento y aprovechamiento de la luz del día)
59395400	BY581X 350S/840 SIA WB GC SI H4	210 W	Sí (se relaciona con la detección de presencia/

Order Code	Full Product Name	Consumo de energía	Adecuado para conmutación aleatoria
59398500	BY581X 250S/840 SIA HE WB GC SI H4	136 W	movimiento y aprovechamiento de la luz del día)
59399200	BY581X 350S/840 SIA HE WB GC SI H4	198 W	Sí (se relaciona con la detección de presencia/ movimiento y aprovechamiento de la luz del día)
59404300	BY581X 250S/840 SIA WB GC SI ELP3 H4	144 W	Sí (se relaciona con la detección de presencia/ movimiento y aprovechamiento de la luz del día)
59405000	BY581X 250S/840 SIA WB GC SI ELW3 H4	144 W	Sí (se relaciona con la detección de presencia/ movimiento y aprovechamiento de la luz del día)
59406700	BY581X 250S/840 SIA HE WB GC SI ELP3 H4	136 W	Sí (se relaciona con la detección de presencia/

Order Code	Full Product Name	Consumo de energía	Adecuado para conmutación aleatoria
			movimiento y aprovechamiento de la luz del día)
59407400	BY581X 250S/840 SIA HE WB GC SI ELW3 H4	136 W	Sí (se relaciona con la detección de presencia/ movimiento y aprovechamiento de la luz del día)
59400500	BY580X 170S/840 SIA WB GC SI H4 BR	102 W	Sí (se relaciona con la detección de presencia/ movimiento y aprovechamiento de la luz del día)
59403600	BY580X 170S/840 SIA HE WB GC SI H4 BR	97 W	Sí (se relaciona con la detección de presencia/ movimiento y aprovechamiento de la luz del día)
59408100	BY580P 170S/840 PSU WB GC SI	102 W	No
59410400	BY580P 170S/840 PSU HE WB GC SI	97 W	No
59412800	BY580P 100S/840 DIA UE WB GC SI	55 W	No
59414200	BY580P 130S/840 DIA WB GC SI	76 W	No
59415900	BY580P 170S/840 DIA WB GC SI	102 W	No
59418000	BY580P 130S/840 DIA HE WB GC SI	73 W	No
59419700	BY580P 170S/840 DIA HE WB GC SI	97 W	No
59422700	BY580P 170S/840 DIA WB PC SI	110 W	No
59426500	BY580P 170S/840 DIA HE WB PC SI	104 W	No
59430200	BY580P 170S/840 DIA WB GC SI ELP3	102 W	No
59432600	BY580P 170S/840 DIA HE WB GC SI ELP3	97 W	No
59434000	BY580P 130S/840 DIA MB GC SI	77 W	No
59435700	BY580P 170S/840 DIA MB GC SI	104 W	No
59438800	BY580P 130S/840 DIA HE MB GC SI	73 W	No
59439500	BY580P 170S/840 DIA HE MB GC SI	98 W	No
58908700	BY580P 170S/840 DIA NB GC SI	104 W	No

Order Code	Full Product Name	Consumo de energía	Adecuado para conmutación aleatoria
58910000	BY580P 170S/840 DIA HE NB GC SI	98 W	No
58912400	BY580P 170S/840 DIA XNB GC SI	104 W	No
58914800	BY580P 170S/840 DIA HE XNB GC SI	98 W	No
58916200	BY580P 170S/840 DIA HRO GC SI	104 W	No
58918600	BY580P 170S/840 DIA HE HRO GC SI	98 W	No
58920900	BY580P 170S/865 DIA WB GC SI	104 W	No
58922300	BY580P 170S/865 DIA HE WB GC SI	99 W	No
58924700	BY580P 170S/830 DIA WB GC SI	110 W	No
58926100	BY580P 170S/830 DIA HE WB GC SI	104 W	No
58928500	BY580P 170S/940 DIA WB GC SI	108 W	No
59036600	BY582P 170S/840 DIA HE WB GC SI 0.5m CW5	102 W	No
59038000	BY582P 170S/840 DIA HE WB GC SI 1m CW5	102 W	No
58904900	BY580P 170S/840 DIA ASYM GC SI MBW	108 W	No
58906300	BY580P 170S/840 DIA HE ASYM GC SI MBW	100 W	No
59425800	BY581P 250S/840 DIA WB GC SI BR	144 W	No
59429600	BY581P 250S/840 DIA HE WB GC SI BR	138 W	No
58901800	BY581P 250S/840 DIA ASYM GC SI BR	152 W	No
58903200	BY581P 250S/840 DIA HE ASYM GC SI BR	142 W	No
58905600	BY581P 250S/840 DIA ASYM GC SI MBW	152 W	No
58907000	BY581P 250S/840 DIA HE ASYM GC SI MBW	142 W	No
58932200	BY581P 350S/840 DIA HE WB GC SI BR XT 1m	198 W	No
59424100	BY580P 170S/840 DIA WB GC SI BR	102 W	No
59428900	BY580P 170S/840 DIA HE WB GC SI BR	97 W	No
58902500	BY580P 170S/840 DIA HE ASYM GC SI BR	100 W	No
59409800	BY581P 250S/840 PSU WB GC SI	144 W	No

Order Code	Full Product Name	Consumo de energía	Adecuado para conmutación aleatoria
59411100	BY581P 250S/840 PSU HE WB GC SI	136 W	No
59413500	BY581P 200S/840 DIA UE WB GC SI	106 W	No
59416600	BY581P 250S/840 DIA WB GC SI	144 W	No
59417300	BY581P 350S/840 DIA WB GC SI	210 W	No
59420300	BY581P 250S/840 DIA HE WB GC SI	138 W	No
59421000	BY581P 350S/840 DIA HE WB GC SI	198 W	No
59423400	BY581P 250S/840 DIA WB PC SI	154 W	No
59427200	BY581P 250S/840 DIA HE WB PC SI	146 W	No
59431900	BY581P 250S/840 DIA WB GC SI ELD3	144 W	No
59433300	BY581P 250S/840 DIA HE WB GC SI ELD3	138 W	No
59436400	BY581P 250S/840 DIA MB GC SI	146 W	No
59437100	BY581P 350S/840 DIA MB GC SI	210 W	No
59440100	BY581P 250S/840 DIA HE MB GC SI	138 W	No
59441800	BY581P 350S/840 DIA HE MB GC SI	200 W	No
58909400	BY581P 250S/840 DIA NB GC SI	146 W	No
58911700	BY581P 250S/840 DIA HE NB GC SI	138 W	No
58913100	BY581P 250S/840 DIA XNB GC SI	146 W	No
58915500	BY581P 250S/840 DIA HE XNB GC SI	138 W	No
58917900	BY581P 250S/840 DIA HRO GC SI	146 W	No
58919300	BY581P 250S/840 DIA HE HRO GC SI	138 W	No

Order Code	Full Product Name	Consumo de energía	Adecuado para conmutación aleatoria
58921600	BY581P 250S/865 DIA WB GC SI	146 W	No
58923000	BY581P 250S/865 DIA HE WB GC SI	140 W	No
58925400	BY581P 250S/830 DIA WB GC SI	154 W	No
58927800	BY581P 250S/830 DIA HE WB GC SI	146 W	No
58929200	BY581P 250S/940 DIA WB GC SI	152 W	No
58930800	BY581P 250S/840 DIA HE WB GC SI XT 1m	138 W	No
58931500	BY581P 350S/840 DIA HE WB GC SI XT 1m	198 W	No
59037300	BY583P 250S/840 DIA HE WB GC SI 0.5m CW5	144 W	No
59039700	BY583P 250S/840 DIA HE WB GC SI 1m CW5	144 W	No
59392300	BY580X 130S/840 SIA WB GC SI H4	76 W	Sí (se relaciona con la detección de presencia/movimiento y aprovechamiento de la luz del día)
59393000	BY580X 170S/840 SIA WB GC SI H4	102 W	Sí (se relaciona con la detección de presencia/movimiento y aprovechamiento de la luz del día)
59396100	BY580X 130S/840 SIA HE WB GC SI H4	73 W	Sí (se relaciona con la detección de presencia/movimiento y aprovechamiento de la luz del día)
59397800	BY580X 170S/840 SIA HE WB GC SI H4	97 W	Sí (se relaciona con la detección de presencia/movimiento y aprovechamiento de la luz del día)

Controles y regulación

Order Code	Full Product Name	Control		Nivel máximo de atenuación
		Regulable	integrado	
58949000	BY581P 700S/840 DIA WB GC SI	Sí	-	10%
58950600	BY581P 700S/840 DIA HE WB GC SI	Sí	-	10%

Order Code	Full Product Name	Control		Nivel máximo de atenuación
		Regulable	integrado	
58951300	BY581P 700S/840 DIA WB GC SI BR	Sí	-	10%
58952000	BY581P 700S/840 DIA HE WB GC SI BR	Sí	-	10%

Order Code	Full Product Name	Regulable	Control		Nivel máximo de atenuación
			integrado		
59401200	BY581X 250S/840 SIA WB GC SI H4 BR	Sí	Sensor SNH (R) 210	-	-
59402900	BY581X 250S/840 SIA HE WB GC SI H4 BR	Sí	Sensor SNH (R) 210	-	-
59394700	BY581X 250S/840 SIA WB GC SI H4	Sí	Sensor SNH (R) 210	-	-
59395400	BY581X 350S/840 SIA WB GC SI H4	Sí	Sensor SNH (R) 210	-	-
59398500	BY581X 250S/840 SIA HE WB GC SI H4	Sí	Sensor SNH (R) 210	-	-
59399200	BY581X 350S/840 SIA HE WB GC SI H4	Sí	Sensor SNH (R) 210	-	-
59404300	BY581X 250S/840 SIA WB GC SI ELP3 H4	Sí	Sensor SNH (R) 210	-	-
59405000	BY581X 250S/840 SIA WB GC SI ELW3 H4	Sí	Sensor SNH (R) 210	-	-
59406700	BY581X 250S/840 SIA HE WB GC SI ELP3 H4	Sí	Sensor SNH (R) 210	-	-
59407400	BY581X 250S/840 SIA HE WB GC SI ELW3 H4	Sí	Sensor SNH (R) 210	-	-
59400500	BY580X 170S/840 SIA WB GC SI H4 BR	Sí	Sensor SNH (R) 210	-	-
59403600	BY580X 170S/840 SIA HE WB GC SI H4 BR	Sí	Sensor SNH (R) 210	-	-
59408100	BY580P 170S/840 PSU WB GC SI	No	-	-	-
59410400	BY580P 170S/840 PSU HE WB GC SI	No	-	-	-
59412800	BY580P 100S/840 DIA UE WB GC SI	Sí	-	-	10%
59414200	BY580P 130S/840 DIA WB GC SI	Sí	-	-	10%
59415900	BY580P 170S/840 DIA WB GC SI	Sí	-	-	10%
59418000	BY580P 130S/840 DIA HE WB GC SI	Sí	-	-	10%
59419700	BY580P 170S/840 DIA HE WB GC SI	Sí	-	-	10%
59422700	BY580P 170S/840 DIA WB PC SI	Sí	-	-	10%
59426500	BY580P 170S/840 DIA HE WB PC SI	Sí	-	-	10%
59430200	BY580P 170S/840 DIA WB GC SI ELP3	Sí	-	-	10%
59432600	BY580P 170S/840 DIA HE WB GC SI ELP3	Sí	-	-	10%
59434000	BY580P 130S/840 DIA MB GC SI	Sí	-	-	10%
59435700	BY580P 170S/840 DIA MB GC SI	Sí	-	-	10%

Order Code	Full Product Name	Regulable	Control		Nivel máximo de atenuación
			integrado		
59438800	BY580P 130S/840 DIA HE MB GC SI	Sí	-	-	10%
59439500	BY580P 170S/840 DIA HE MB GC SI	Sí	-	-	10%
58908700	BY580P 170S/840 DIA NB GC SI	Sí	-	-	10%
58910000	BY580P 170S/840 DIA HE NB GC SI	Sí	-	-	10%
58912400	BY580P 170S/840 DIA XNB GC SI	Sí	-	-	10%
58914800	BY580P 170S/840 DIA HE XNB GC SI	Sí	-	-	10%
58916200	BY580P 170S/840 DIA HRO GC SI	Sí	-	-	10%
58918600	BY580P 170S/840 DIA HE HRO GC SI	Sí	-	-	10%
58920900	BY580P 170S/865 DIA WB GC SI	Sí	-	-	10%
58922300	BY580P 170S/865 DIA HE WB GC SI	Sí	-	-	10%
58924700	BY580P 170S/830 DIA WB GC SI	Sí	-	-	10%
58926100	BY580P 170S/830 DIA HE WB GC SI	Sí	-	-	10%
58928500	BY580P 170S/940 DIA WB GC SI	Sí	-	-	10%
59036600	BY582P 170S/840 DIA HE WB GC SI 0.5m CW5	DALI	-	-	10%
59038000	BY582P 170S/840 DIA HE WB GC SI 1m CW5	DALI	-	-	10%
58904900	BY580P 170S/840 DIA ASYM GC SI MBW	Sí	-	-	10%
58906300	BY580P 170S/840 DIA HE ASYM GC SI MBW	Sí	-	-	10%
59425800	BY581P 250S/840 DIA WB GC SI BR	Sí	-	-	10%
59429600	BY581P 250S/840 DIA HE WB GC SI BR	Sí	-	-	10%
58901800	BY581P 250S/840 DIA ASYM GC SI BR	Sí	-	-	10%
58903200	BY581P 250S/840 DIA HE ASYM GC SI BR	Sí	-	-	10%
58905600	BY581P 250S/840 DIA ASYM GC SI MBW	Sí	-	-	10%
58907000	BY581P 250S/840 DIA HE ASYM GC SI MBW	Sí	-	-	10%
58932200	BY581P 350S/840 DIA HE WB GC SI BR XT 1m	Sí	-	-	10%
59424100	BY580P 170S/840 DIA WB GC SI BR	Sí	-	-	10%

Order Code	Full Product Name	Control		Nivel máximo de atenuación
		Regulable	integrado	
59428900	BY580P 170S/840 DIA HE WB GC SI BR	Sí	-	10%
58902500	BY580P 170S/840 DIA HE ASYM GC SI BR	Sí	-	10%
59409800	BY581P 250S/840 PSU WB GC SI	No	-	-
59411100	BY581P 250S/840 PSU HE WB GC SI	No	-	-
59413500	BY581P 200S/840 DIA UE WB GC SI	Sí	-	10%
59416600	BY581P 250S/840 DIA WB GC SI	Sí	-	10%
59417300	BY581P 350S/840 DIA WB GC SI	Sí	-	10%
59420300	BY581P 250S/840 DIA HE WB GC SI	Sí	-	10%
59421000	BY581P 350S/840 DIA HE WB GC SI	Sí	-	10%
59423400	BY581P 250S/840 DIA WB PC SI	Sí	-	10%
59427200	BY581P 250S/840 DIA HE WB PC SI	Sí	-	10%
59431900	BY581P 250S/840 DIA WB GC SI ELD3	Sí	-	10%
59433300	BY581P 250S/840 DIA HE WB GC SI ELD3	Sí	-	10%
59436400	BY581P 250S/840 DIA MB GC SI	Sí	-	10%
59437100	BY581P 350S/840 DIA MB GC SI	Sí	-	10%
59440100	BY581P 250S/840 DIA HE MB GC SI	Sí	-	10%
59441800	BY581P 350S/840 DIA HE MB GC SI	Sí	-	10%
58909400	BY581P 250S/840 DIA NB GC SI	Sí	-	10%
58911700	BY581P 250S/840 DIA HE NB GC SI	Sí	-	10%

Order Code	Full Product Name	Control		Nivel máximo de atenuación
		Regulable	integrado	
58913100	BY581P 250S/840 DIA XNB GC SI	Sí	-	10%
58915500	BY581P 250S/840 DIA HE XNB GC SI	Sí	-	10%
58917900	BY581P 250S/840 DIA HRO GC SI	Sí	-	10%
58919300	BY581P 250S/840 DIA HE HRO GC SI	Sí	-	10%
58921600	BY581P 250S/865 DIA WB GC SI	Sí	-	10%
58923000	BY581P 250S/865 DIA HE WB GC SI	Sí	-	10%
58925400	BY581P 250S/830 DIA WB GC SI	Sí	-	10%
58927800	BY581P 250S/830 DIA HE WB GC SI	Sí	-	10%
58929200	BY581P 250S/940 DIA WB GC SI	Sí	-	10%
58930800	BY581P 250S/840 DIA HE WB GC SI XT 1m	Sí	-	10%
58931500	BY581P 350S/840 DIA HE WB GC SI XT 1m	Sí	-	10%
59037300	BY583P 250S/840 DIA HE WB GC SI 0.5m CW5	DALI	-	10%
59039700	BY583P 250S/840 DIA HE WB GC SI 1m CW5	DALI	-	10%
59392300	BY580X 130S/840 SIA WB GC SI H4	Sí	Sensor SNH (R) 210	-
59393000	BY580X 170S/840 SIA WB GC SI H4	Sí	Sensor SNH (R) 210	-
59396100	BY580X 130S/840 SIA HE WB GC SI H4	Sí	Sensor SNH (R) 210	-
59397800	BY580X 170S/840 SIA HE WB GC SI H4	Sí	Sensor SNH (R) 210	-

Mecánicos y de carcasa

Order Code	Full Product Name	Índice de protección frente a choque mecánico
58949000	BY581P 700S/840 DIA WB GC SI	IK07
58950600	BY581P 700S/840 DIA HE WB GC SI	IK07
58951300	BY581P 700S/840 DIA WB GC SI BR	IK07
58952000	BY581P 700S/840 DIA HE WB GC SI BR	IK07
59401200	BY581X 250S/840 SIA WB GC SI H4 BR	IK03
59402900	BY581X 250S/840 SIA HE WB GC SI H4 BR	IK03
59394700	BY581X 250S/840 SIA WB GC SI H4	IK03
59395400	BY581X 350S/840 SIA WB GC SI H4	IK03

Order Code	Full Product Name	Índice de protección frente a choque mecánico
59398500	BY581X 250S/840 SIA HE WB GC SI H4	IK03
59399200	BY581X 350S/840 SIA HE WB GC SI H4	IK03
59404300	BY581X 250S/840 SIA WB GC SI ELP3 H4	IK03
59405000	BY581X 250S/840 SIA WB GC SI ELW3 H4	IK03
59406700	BY581X 250S/840 SIA HE WB GC SI ELP3 H4	IK03
59407400	BY581X 250S/840 SIA HE WB GC SI ELW3 H4	IK03
59400500	BY580X 170S/840 SIA WB GC SI H4 BR	IK03
59403600	BY580X 170S/840 SIA HE WB GC SI H4 BR	IK03

Order Code	Full Product Name	Índice de protección frente a choque mecánico
59408100	BY580P 170S/840 PSU WB GC SI	IK07
59410400	BY580P 170S/840 PSU HE WB GC SI	IK07
59412800	BY580P 100S/840 DIA UE WB GC SI	IK07
59414200	BY580P 130S/840 DIA WB GC SI	IK07
59415900	BY580P 170S/840 DIA WB GC SI	IK07
59418000	BY580P 130S/840 DIA HE WB GC SI	IK07
59419700	BY580P 170S/840 DIA HE WB GC SI	IK07
59422700	BY580P 170S/840 DIA WB PC SI	IK07
59426500	BY580P 170S/840 DIA HE WB PC SI	IK07
59430200	BY580P 170S/840 DIA WB GC SI ELP3	IK07
59432600	BY580P 170S/840 DIA HE WB GC SI ELP3	IK07
59434000	BY580P 130S/840 DIA MB GC SI	IK07
59435700	BY580P 170S/840 DIA MB GC SI	IK07
59438800	BY580P 130S/840 DIA HE MB GC SI	IK07
59439500	BY580P 170S/840 DIA HE MB GC SI	IK07
58908700	BY580P 170S/840 DIA NB GC SI	IK07
58910000	BY580P 170S/840 DIA HE NB GC SI	IK07
58912400	BY580P 170S/840 DIA XNB GC SI	IK07
58914800	BY580P 170S/840 DIA HE XNB GC SI	IK07
58916200	BY580P 170S/840 DIA HRO GC SI	IK07
58918600	BY580P 170S/840 DIA HE HRO GC SI	IK07
58920900	BY580P 170S/865 DIA WB GC SI	IK07
58922300	BY580P 170S/865 DIA HE WB GC SI	IK07
58924700	BY580P 170S/830 DIA WB GC SI	IK07
58926100	BY580P 170S/830 DIA HE WB GC SI	IK07
58928500	BY580P 170S/940 DIA WB GC SI	IK07
59036600	BY582P 170S/840 DIA HE WB GC SI 0.5m CW5	IK07
59038000	BY582P 170S/840 DIA HE WB GC SI 1m CW5	IK07
58904900	BY580P 170S/840 DIA ASYM GC SI MBW	IK07
58906300	BY580P 170S/840 DIA HE ASYM GC SI MBW	IK07
59425800	BY581P 250S/840 DIA WB GC SI BR	IK07
59429600	BY581P 250S/840 DIA HE WB GC SI BR	IK07
58901800	BY581P 250S/840 DIA ASYM GC SI BR	IK07
58903200	BY581P 250S/840 DIA HE ASYM GC SI BR	IK07
58905600	BY581P 250S/840 DIA ASYM GC SI MBW	IK07
58907000	BY581P 250S/840 DIA HE ASYM GC SI MBW	IK07
58932200	BY581P 350S/840 DIA HE WB GC SI BR XT 1m	IK07

Order Code	Full Product Name	Índice de protección frente a choque mecánico
59424100	BY580P 170S/840 DIA WB GC SI BR	IK07
59428900	BY580P 170S/840 DIA HE WB GC SI BR	IK07
58902500	BY580P 170S/840 DIA HE ASYM GC SI BR	IK07
59409800	BY581P 250S/840 PSU WB GC SI	IK07
59411100	BY581P 250S/840 PSU HE WB GC SI	IK07
59413500	BY581P 200S/840 DIA UE WB GC SI	IK07
59416600	BY581P 250S/840 DIA WB GC SI	IK07
59417300	BY581P 350S/840 DIA WB GC SI	IK07
59420300	BY581P 250S/840 DIA HE WB GC SI	IK07
59421000	BY581P 350S/840 DIA HE WB GC SI	IK07
59423400	BY581P 250S/840 DIA WB PC SI	IK07
59427200	BY581P 250S/840 DIA HE WB PC SI	IK07
59431900	BY581P 250S/840 DIA WB GC SI ELD3	IK07
59433300	BY581P 250S/840 DIA HE WB GC SI ELD3	IK07
59436400	BY581P 250S/840 DIA MB GC SI	IK07
59437100	BY581P 350S/840 DIA MB GC SI	IK07
59440100	BY581P 250S/840 DIA HE MB GC SI	IK07
59441800	BY581P 350S/840 DIA HE MB GC SI	IK07
58909400	BY581P 250S/840 DIA NB GC SI	IK07
58911700	BY581P 250S/840 DIA HE NB GC SI	IK07
58913100	BY581P 250S/840 DIA XNB GC SI	IK07
58915500	BY581P 250S/840 DIA HE XNB GC SI	IK07
58917900	BY581P 250S/840 DIA HRO GC SI	IK07
58919300	BY581P 250S/840 DIA HE HRO GC SI	IK07
58921600	BY581P 250S/865 DIA WB GC SI	IK07
58923000	BY581P 250S/865 DIA HE WB GC SI	IK07
58925400	BY581P 250S/830 DIA WB GC SI	IK07
58927800	BY581P 250S/830 DIA HE WB GC SI	IK07
58929200	BY581P 250S/940 DIA WB GC SI	IK07
58930800	BY581P 250S/840 DIA HE WB GC SI XT 1m	IK07
58931500	BY581P 350S/840 DIA HE WB GC SI XT 1m	IK07
59037300	BY583P 250S/840 DIA HE WB GC SI 0.5m CW5	IK07
59039700	BY583P 250S/840 DIA HE WB GC SI 1m CW5	IK07
59392300	BY580X 130S/840 SIA WB GC SI H4	IK03
59393000	BY580X 170S/840 SIA WB GC SI H4	IK03
59396100	BY580X 130S/840 SIA HE WB GC SI H4	IK03
59397800	BY580X 170S/840 SIA HE WB GC SI H4	IK03

Funcionamiento de emergencia (1/2)

Order Code	Full Product Name	Iluminación		Tipo de batería de iluminación de emergencia	Consumo de energía durante el modo de emergencia de CC centralizado
		de emergencia	Flujo de emergencia		
58949000	BY581P 700S/840 DIA WB GC SI	-	-	-	-

Order Code	Full Product Name	Iluminación		Tipo de batería de iluminación de emergencia	Consumo de energía durante el modo de emergencia de CC centralizado
		de emergencia	Flujo de emergencia		
58950600	BY581P 700S/840 DIA HE WB GC SI	-	-	-	-

Order Code	Full Product Name	Iluminación de emergencia	Flujo de emergencia	Tipo de batería de iluminación de emergencia	Consumo de energía durante el modo de emergencia de CC centralizado
58951300	BY581P 700S/840 DIA WB GC SI BR	-	-	-	-
58952000	BY581P 700S/840 DIA HE WB GC SI BR	-	-	-	-
59401200	BY581X 250S/840 SIA WB GC SI H4 BR	-	-	-	-
59402900	BY581X 250S/840 SIA HE WB GC SI H4 BR	-	-	-	-
59394700	BY581X 250S/840 SIA WB GC SI H4	-	-	-	-
59395400	BY581X 350S/840 SIA WB GC SI H4	-	-	-	-
59398500	BY581X 250S/840 SIA HE WB GC SI H4	-	-	-	-
59399200	BY581X 350S/840 SIA HE WB GC SI H4	-	-	-	-
59404300	BY581X 250S/840 SIA WB GC SI ELP3 H4	Iluminación de emergencia de 3 horas de duración versión Pro	850 lm	Lithium	5 W
59405000	BY581X 250S/840 SIA WB GC SI ELW3 H4	Iluminación de emergencia de 3 horas de duración con interfaz inalámbrica	850 lm	Lithium	5 W
59406700	BY581X 250S/840 SIA HE WB GC SI ELP3 H4	Iluminación de emergencia de 3 horas de	850 lm	Lithium	5 W

Order Code	Full Product Name	Iluminación de emergencia	Flujo de emergencia	Tipo de batería de iluminación de emergencia	Consumo de energía durante el modo de emergencia de CC centralizado
59407400	BY581X 250S/840 SIA HE WB GC SI ELW3 H4	Iluminación de emergencia de 3 horas de duración con interfaz inalámbrica	850 lm	Lithium	5 W
59400500	BY580X 170S/840 SIA WB GC SI H4 BR	-	-	-	-
59403600	BY580X 170S/840 SIA HE WB GC SI H4 BR	-	-	-	-
59408100	BY580P 170S/840 PSU WB GC SI	-	-	-	-
59410400	BY580P 170S/840 PSU HE WB GC SI	-	-	-	-
59412800	BY580P 100S/840 DIA UE WB GC SI	-	-	-	-
59414200	BY580P 130S/840 DIA WB GC SI	-	-	-	-
59415900	BY580P 170S/840 DIA WB GC SI	-	-	-	-
59418000	BY580P 130S/840 DIA HE WB GC SI	-	-	-	-
59419700	BY580P 170S/840 DIA HE WB GC SI	-	-	-	-
59422700	BY580P 170S/840 DIA WB PC SI	-	-	-	-
59426500	BY580P 170S/840 DIA HE WB PC SI	-	-	-	-

Order Code	Full Product Name	Iluminación de emergencia	Flujo de emergencia	Tipo de batería de iluminación de emergencia	Consumo de energía durante el modo de emergencia de CC centralizado
59430200	BY580P 170S/840 DIA WB GC SI ELP3	Iluminación de emergencia de 3 horas de duración versión Pro	450 lm	Lithium	3 W
59432600	BY580P 170S/840 DIA HE WB GC SI ELP3	Iluminación de emergencia de 3 horas de duración versión Pro	450 lm	Lithium	3 W
59434000	BY580P 130S/840 DIA MB GC SI	-	-	-	-
59435700	BY580P 170S/840 DIA MB GC SI	-	-	-	-
59438800	BY580P 130S/840 DIA HE MB GC SI	-	-	-	-
59439500	BY580P 170S/840 DIA HE MB GC SI	-	-	-	-
58908700	BY580P 170S/840 DIA NB GC SI	-	-	-	-
58910000	BY580P 170S/840 DIA HE NB GC SI	-	-	-	-
58912400	BY580P 170S/840 DIA XNB GC SI	-	-	-	-
58914800	BY580P 170S/840 DIA HE XNB GC SI	-	-	-	-
58916200	BY580P 170S/840 DIA HRO GC SI	-	-	-	-
58918600	BY580P 170S/840 DIA HE HRO GC SI	-	-	-	-
58920900	BY580P 170S/865 DIA WB GC SI	-	-	-	-

Order Code	Full Product Name	Iluminación de emergencia	Flujo de emergencia	Tipo de batería de iluminación de emergencia	Consumo de energía durante el modo de emergencia de CC centralizado
58922300	BY580P 170S/865 DIA HE WB GC SI	-	-	-	-
58924700	BY580P 170S/830 DIA WB GC SI	-	-	-	-
58926100	BY580P 170S/830 DIA HE WB GC SI	-	-	-	-
58928500	BY580P 170S/940 DIA WB GC SI	-	-	-	-
59036600	BY582P 170S/840 DIA HE WB GC SI 0.5m CW5	-	-	-	-
59038000	BY582P 170S/840 DIA HE WB GC SI 1m CW5	-	-	-	-
58904900	BY580P 170S/840 DIA ASYM GC SI MBW	-	-	-	-
58906300	BY580P 170S/840 DIA HE ASYM GC SI MBW	-	-	-	-
59425800	BY581P 250S/840 DIA WB GC SI BR	-	-	-	-
59429600	BY581P 250S/840 DIA HE WB GC SI BR	-	-	-	-
58901800	BY581P 250S/840 DIA ASYM GC SI BR	-	-	-	-
58903200	BY581P 250S/840 DIA HE ASYM GC SI BR	-	-	-	-
58905600	BY581P 250S/840 DIA ASYM GC SI MBW	-	-	-	-

Order Code	Full Product Name	Illuminación de emergencia	Flujo de emergencia	Tipo de batería de iluminación de emergencia	Consumo de energía durante el modo de emergencia de CC centralizado
58907000	BY581P 250S/840 DIA HE ASYM GC SI MBW	-	-	-	-
58932200	BY581P 350S/840 DIA HE WB GC SI BR XT 1m	-	-	-	-
59424100	BY580P 170S/840 DIA WB GC SI BR	-	-	-	-
59428900	BY580P 170S/840 DIA HE WB GC SI BR	-	-	-	-
58902500	BY580P 170S/840 DIA HE ASYM GC SI BR	-	-	-	-
59409800	BY581P 250S/840 PSU WB GC SI	-	-	-	-
59411100	BY581P 250S/840 PSU HE WB GC SI	-	-	-	-
59413500	BY581P 200S/840 DIA UE WB GC SI	-	-	-	-
59416600	BY581P 250S/840 DIA WB GC SI	-	-	-	-
59417300	BY581P 350S/840 DIA WB GC SI	-	-	-	-
59420300	BY581P 250S/840 DIA HE WB GC SI	-	-	-	-
59421000	BY581P 350S/840 DIA HE WB GC SI	-	-	-	-
59423400	BY581P 250S/840 DIA WB PC SI	-	-	-	-
59427200	BY581P 250S/840 DIA HE WB PC SI	-	-	-	-

Order Code	Full Product Name	Illuminación de emergencia	Flujo de emergencia	Tipo de batería de iluminación de emergencia	Consumo de energía durante el modo de emergencia de CC centralizado
59431900	BY581P 250S/840 DIA WB GC SI ELD3	Iluminación de emergencia de 3 horas de duración con interfaz DALI	850 lm	Lithium	5 W
59433300	BY581P 250S/840 DIA HE WB GC SI ELD3	Iluminación de emergencia de 3 horas de duración con interfaz DALI	850 lm	Lithium	5 W
59436400	BY581P 250S/840 DIA MB GC SI	-	-	-	-
59437100	BY581P 350S/840 DIA MB GC SI	-	-	-	-
59440100	BY581P 250S/840 DIA HE MB GC SI	-	-	-	-
59441800	BY581P 350S/840 DIA HE MB GC SI	-	-	-	-
58909400	BY581P 250S/840 DIA NB GC SI	-	-	-	-
58911700	BY581P 250S/840 DIA HE NB GC SI	-	-	-	-
58913100	BY581P 250S/840 DIA XNB GC SI	-	-	-	-
58915500	BY581P 250S/840 DIA HE XNB GC SI	-	-	-	-
58917900	BY581P 250S/840 DIA HRO GC SI	-	-	-	-
58919300	BY581P 250S/840 DIA HE HRO GC SI	-	-	-	-
58921600	BY581P 250S/865 DIA WB GC SI	-	-	-	-

Order Code	Full Product Name	Iluminación de emergencia	Flujo de emergencia	Tipo de batería de iluminación de emergencia	Consumo de energía durante el modo de emergencia de CC centralizado
58923000	BY581P 250S/865 DIA HE WB GC SI	-	-	-	-
58925400	BY581P 250S/830 DIA WB GC SI	-	-	-	-
58927800	BY581P 250S/830 DIA HE WB GC SI	-	-	-	-
58929200	BY581P 250S/940 DIA WB GC SI	-	-	-	-
58930800	BY581P 250S/840 DIA HE WB GC SI XT 1m	-	-	-	-
58931500	BY581P 350S/840 DIA HE WB GC SI XT 1m	-	-	-	-
59037300	BY583P 250S/840 DIA	-	-	-	-

Order Code	Full Product Name	Iluminación de emergencia	Flujo de emergencia	Tipo de batería de iluminación de emergencia	Consumo de energía durante el modo de emergencia de CC centralizado
	HE WB GC SI 0.5m CW5				
59039700	BY583P 250S/840 DIA HE WB GC SI 1m CW5	-	-	-	-
59392300	BY580X 130S/840 SIA WB GC SI H4	-	-	-	-
59393000	BY580X 170S/840 SIA WB GC SI H4	-	-	-	-
59396100	BY580X 130S/840 SIA HE WB GC SI H4	-	-	-	-
59397800	BY580X 170S/840 SIA HE WB GC SI H4	-	-	-	-

Funcionamiento de emergencia (2/2)

Order Code	Full Product Name	Duración nominal de la iluminación de emergencia (cuando está totalmente cargada)
58949000	BY581P 700S/840 DIA WB GC SI	-
58950600	BY581P 700S/840 DIA HE WB GC SI	-
58951300	BY581P 700S/840 DIA WB GC SI BR	-
58952000	BY581P 700S/840 DIA HE WB GC SI BR	-
59401200	BY581X 250S/840 SIA WB GC SI H4 BR	-
59402900	BY581X 250S/840 SIA HE WB GC SI H4 BR	-
59394700	BY581X 250S/840 SIA WB GC SI H4	-
59395400	BY581X 350S/840 SIA WB GC SI H4	-
59398500	BY581X 250S/840 SIA HE WB GC SI H4	-
59399200	BY581X 350S/840 SIA HE WB GC SI H4	-
59404300	BY581X 250S/840 SIA WB GC SI ELP3 H4	3 hora(s)
59405000	BY581X 250S/840 SIA WB GC SI ELW3 H4	3 hora(s)
59406700	BY581X 250S/840 SIA HE WB GC SI ELP3 H4	3 hora(s)
59407400	BY581X 250S/840 SIA HE WB GC SI ELW3 H4	3 hora(s)
59400500	BY580X 170S/840 SIA WB GC SI H4 BR	-
59403600	BY580X 170S/840 SIA HE WB GC SI H4 BR	-
59408100	BY580P 170S/840 PSU WB GC SI	-

Order Code	Full Product Name	Duración nominal de la iluminación de emergencia (cuando está totalmente cargada)
59410400	BY580P 170S/840 PSU HE WB GC SI	-
59412800	BY580P 100S/840 DIA UE WB GC SI	-
59414200	BY580P 130S/840 DIA WB GC SI	-
59415900	BY580P 170S/840 DIA WB GC SI	-
59418000	BY580P 130S/840 DIA HE WB GC SI	-
59419700	BY580P 170S/840 DIA HE WB GC SI	-
59422700	BY580P 170S/840 DIA WB PC SI	-
59426500	BY580P 170S/840 DIA HE WB PC SI	-
59430200	BY580P 170S/840 DIA WB GC SI ELP3	3 hora(s)
59432600	BY580P 170S/840 DIA HE WB GC SI ELP3	3 hora(s)
59434000	BY580P 130S/840 DIA MB GC SI	-
59435700	BY580P 170S/840 DIA MB GC SI	-
59438800	BY580P 130S/840 DIA HE MB GC SI	-
59439500	BY580P 170S/840 DIA HE MB GC SI	-
58908700	BY580P 170S/840 DIA NB GC SI	-
58910000	BY580P 170S/840 DIA HE NB GC SI	-
58912400	BY580P 170S/840 DIA XNB GC SI	-

Order Code	Full Product Name	Duración nominal de la iluminación de emergencia (cuando está totalmente cargada)
58914800	BY580P 170S/840 DIA HE XNB GC SI	-
58916200	BY580P 170S/840 DIA HRO GC SI	-
58918600	BY580P 170S/840 DIA HE HRO GC SI	-
58920900	BY580P 170S/865 DIA WB GC SI	-
58922300	BY580P 170S/865 DIA HE WB GC SI	-
58924700	BY580P 170S/830 DIA WB GC SI	-
58926100	BY580P 170S/830 DIA HE WB GC SI	-
58928500	BY580P 170S/940 DIA WB GC SI	-
59036600	BY582P 170S/840 DIA HE WB GC SI 0.5m CW5	-
59038000	BY582P 170S/840 DIA HE WB GC SI 1m CW5	-
58904900	BY580P 170S/840 DIA ASYM GC SI MBW	-
58906300	BY580P 170S/840 DIA HE ASYM GC SI MBW	-
59425800	BY581P 250S/840 DIA WB GC SI BR	-
59429600	BY581P 250S/840 DIA HE WB GC SI BR	-
58901800	BY581P 250S/840 DIA ASYM GC SI BR	-
58903200	BY581P 250S/840 DIA HE ASYM GC SI BR	-
58905600	BY581P 250S/840 DIA ASYM GC SI MBW	-
58907000	BY581P 250S/840 DIA HE ASYM GC SI MBW	-
58932200	BY581P 350S/840 DIA HE WB GC SI BR XT 1m	-
59424100	BY580P 170S/840 DIA WB GC SI BR	-
59428900	BY580P 170S/840 DIA HE WB GC SI BR	-
58902500	BY580P 170S/840 DIA HE ASYM GC SI BR	-
59409800	BY581P 250S/840 PSU WB GC SI	-
59411100	BY581P 250S/840 PSU HE WB GC SI	-
59413500	BY581P 200S/840 DIA UE WB GC SI	-
59416600	BY581P 250S/840 DIA WB GC SI	-
59417300	BY581P 350S/840 DIA WB GC SI	-
59420300	BY581P 250S/840 DIA HE WB GC SI	-

Order Code	Full Product Name	Duración nominal de la iluminación de emergencia (cuando está totalmente cargada)
59421000	BY581P 350S/840 DIA HE WB GC SI	-
59423400	BY581P 250S/840 DIA WB PC SI	-
59427200	BY581P 250S/840 DIA HE WB PC SI	-
59431900	BY581P 250S/840 DIA WB GC SI ELD3	3 hora(s)
59433300	BY581P 250S/840 DIA HE WB GC SI ELD3	3 hora(s)
59436400	BY581P 250S/840 DIA MB GC SI	-
59437100	BY581P 350S/840 DIA MB GC SI	-
59440100	BY581P 250S/840 DIA HE MB GC SI	-
59441800	BY581P 350S/840 DIA HE MB GC SI	-
58909400	BY581P 250S/840 DIA NB GC SI	-
58911700	BY581P 250S/840 DIA HE NB GC SI	-
58913100	BY581P 250S/840 DIA XNB GC SI	-
58915500	BY581P 250S/840 DIA HE XNB GC SI	-
58917900	BY581P 250S/840 DIA HRO GC SI	-
58919300	BY581P 250S/840 DIA HE HRO GC SI	-
58921600	BY581P 250S/865 DIA WB GC SI	-
58923000	BY581P 250S/865 DIA HE WB GC SI	-
58925400	BY581P 250S/830 DIA WB GC SI	-
58927800	BY581P 250S/830 DIA HE WB GC SI	-
58929200	BY581P 250S/940 DIA WB GC SI	-
58930800	BY581P 250S/840 DIA HE WB GC SI XT 1m	-
58931500	BY581P 350S/840 DIA HE WB GC SI XT 1m	-
59037300	BY583P 250S/840 DIA HE WB GC SI 0.5m CW5	-
59039700	BY583P 250S/840 DIA HE WB GC SI 1m CW5	-
59392300	BY580X 130S/840 SIA WB GC SI H4	-
59393000	BY580X 170S/840 SIA WB GC SI H4	-
59396100	BY580X 130S/840 SIA HE WB GC SI H4	-
59397800	BY580X 170S/840 SIA HE WB GC SI H4	-

Aprobación y aplicación

Order Code	Full Product Name	Rango de temperatura ambiente	Test del hilo incandescente	Valor de parpadeo (PstLM)	Valor de efecto estroboscópico (SVM)
58949000	BY581P 700S/840 DIA WB GC SI	-30 °C a +55 °C	Temperatura 650 °C, duración 30 s	0,22	0,01
58950600	BY581P 700S/840 DIA HE WB GC SI	-30 °C a +55 °C	Temperatura 650 °C, duración 30 s	0,22	0,01
58951300	BY581P 700S/840 DIA WB GC SI BR	-30 °C a +55 °C	Temperatura 650 °C, duración 30 s	0,22	0,01
58952000	BY581P 700S/840	-30 °C a +55 °C	Temperatura 650 °C, duración 30 s	0,22	0,01

Order Code	Full Product Name	Rango de temperatura ambiente	Test del hilo incandescente	Valor de parpadeo (PstLM)	Valor de efecto estroboscópico (SVM)
59401200	BY581X 250S/840 SIA WB GC SI H4 BR	-30 °C a +55 °C	Temperatura 650 °C, duración 30 s	1	0,4
59402900	BY581X 250S/840 SIA HE WB GC SI H4 BR	-30 °C a +55 °C	Temperatura 650 °C, duración 30 s	1	0,4
59394700	BY581X 250S/840 SIA WB GC SI H4	-30 °C a +55 °C	Temperatura 650 °C, duración 30 s	1	0,4

Order Code	Full Product Name	Rango de temperatura ambiente	Test del hilo incandescente	Valor de parpadeo (PstLM)	Valor de efecto estroboscópico (SVM)
59395400	BY581X 350S/840 SIA WB GC SI H4	-30 °C a +55 °C	Temperatura 650 °C, duración 30 s	1	0,4
59398500	BY581X 250S/840 SIA HE WB GC SI H4	-30 °C a +55 °C	Temperatura 650 °C, duración 30 s	1	0,4
59399200	BY581X 350S/840 SIA HE WB GC SI H4	-30 °C a +55 °C	Temperatura 650 °C, duración 30 s	1	0,4
59404300	BY581X 250S/840 SIA WB GC SI ELP3 H4	0 °C a 25 °C	Temperatura 850 °C, duración 30 s	1	0,4
59405000	BY581X 250S/840 SIA WB GC SI ELW3 H4	0 °C a 25 °C	Temperatura 850 °C, duración 30 s	1	0,4
59406700	BY581X 250S/840 SIA HE WB GC SI ELP3 H4	0 °C a 25 °C	Temperatura 850 °C, duración 30 s	1	0,4
59407400	BY581X 250S/840 SIA HE WB GC SI ELW3 H4	0 °C a 25 °C	Temperatura 850 °C, duración 30 s	1	0,4
59400500	BY580X 170S/840 SIA WB GC SI H4 BR	-30 °C a +55 °C	Temperatura 650 °C, duración 30 s	1	0,4
59403600	BY580X 170S/840 SIA HE WB GC SI H4 BR	-30 °C a +55 °C	Temperatura 650 °C, duración 30 s	1	0,4
59408100	BY580P 170S/840 PSU WB GC SI	-30 °C a +55 °C	Temperatura 650 °C, duración 30 s	0,04	0,07
59410400	BY580P 170S/840 PSU HE WB GC SI	-30 °C a +55 °C	Temperatura 650 °C, duración 30 s	0,04	0,07

Order Code	Full Product Name	Rango de temperatura ambiente	Test del hilo incandescente	Valor de parpadeo (PstLM)	Valor de efecto estroboscópico (SVM)
59412800	BY580P 100S/840 DIA UE WB GC SI	-30 °C a +55 °C	Temperatura 650 °C, duración 30 s	-	-
59414200	BY580P 130S/840 DIA WB GC SI	-30 °C a +55 °C	Temperatura 650 °C, duración 30 s	-	-
59415900	BY580P 170S/840 DIA WB GC SI	-30 °C a +55 °C	Temperatura 650 °C, duración 30 s	0,12	0,07
59418000	BY580P 130S/840 DIA HE WB GC SI	-30 °C a +55 °C	Temperatura 650 °C, duración 30 s	-	-
59419700	BY580P 170S/840 DIA HE WB GC SI	-30 °C a +55 °C	Temperatura 650 °C, duración 30 s	-	-
59422700	BY580P 170S/840 DIA WB PC SI	-30 °C a +55 °C	Temperatura 650 °C, duración 30 s	0,12	0,07
59426500	BY580P 170S/840 DIA HE WB PC SI	-30 °C a +55 °C	Temperatura 650 °C, duración 30 s	-	-
59430200	BY580P 170S/840 DIA WB GC SI ELP3	0 °C a 25 °C	Temperatura 850 °C, duración 30 s	0,12	0,07
59432600	BY580P 170S/840 DIA HE WB GC SI ELP3	0 °C a 25 °C	Temperatura 850 °C, duración 30 s	-	-
59434000	BY580P 130S/840 DIA MB GC SI	-30 °C a +55 °C	Temperatura 650 °C, duración 30 s	-	-
59435700	BY580P 170S/840 DIA MB GC SI	-30 °C a +55 °C	Temperatura 650 °C, duración 30 s	0,12	0,07
59438800	BY580P 130S/840 DIA HE MB GC SI	-30 °C a +55 °C	Temperatura 650 °C, duración 30 s	-	-

Order Code	Full Product Name	Rango de temperatura ambiente	Test del hilo incandescente	Valor de parpadeo (PstLM)	Valor de efecto estroboscópico (SVM)
59439500	BY580P 170S/840 DIA HE MB GC SI	-30 °C a +55 °C	Temperatura 650 °C, duración 30 s	-	-
58908700	BY580P 170S/840 DIA NB GC SI	-30 °C a +55 °C	Temperatura 650 °C, duración 30 s	-	-
58910000	BY580P 170S/840 DIA HE NB GC SI	-30 °C a +55 °C	Temperatura 650 °C, duración 30 s	-	-
58912400	BY580P 170S/840 DIA XNB GC SI	-30 °C a +55 °C	Temperatura 650 °C, duración 30 s	0,12	0,07
58914800	BY580P 170S/840 DIA HE XNB GC SI	-30 °C a +55 °C	Temperatura 650 °C, duración 30 s	-	-
58916200	BY580P 170S/840 DIA HRO GC SI	-30 °C a +55 °C	Temperatura 650 °C, duración 30 s	0,12	0,07
58918600	BY580P 170S/840 DIA HE HRO GC SI	-30 °C a +55 °C	Temperatura 650 °C, duración 30 s	-	-
58920900	BY580P 170S/865 DIA WB GC SI	-30 °C a +55 °C	Temperatura 650 °C, duración 30 s	0,12	0,07
58922300	BY580P 170S/865 DIA HE WB GC SI	-30 °C a +55 °C	Temperatura 650 °C, duración 30 s	-	-
58924700	BY580P 170S/830 DIA WB GC SI	-30 °C a +55 °C	Temperatura 650 °C, duración 30 s	0,12	0,07
58926100	BY580P 170S/830 DIA HE WB GC SI	-30 °C a +55 °C	Temperatura 650 °C, duración 30 s	-	-
58928500	BY580P 170S/940 DIA WB GC SI	-30 °C a +55 °C	Temperatura 650 °C, duración 30 s	0,12	0,07

Order Code	Full Product Name	Rango de temperatura ambiente	Test del hilo incandescente	Valor de parpadeo (PstLM)	Valor de efecto estroboscópico (SVM)
59036600	BY582P 170S/840 DIA HE WB GC SI 0.5m CW5	-30 °C a +55 °C	Temperatura 650 °C, duración 30 s	0,12	0,07
59038000	BY582P 170S/840 DIA HE WB GC SI 1m CW5	-30 °C a +55 °C	Temperatura 650 °C, duración 30 s	0,12	0,07
58904900	BY580P 170S/840 DIA ASYM GC SI MBW	-30 °C a +55 °C	Temperatura 650 °C, duración 30 s	0,12	0,07
58906300	BY580P 170S/840 DIA HE ASYM GC SI MBW	-30 °C a +55 °C	Temperatura 650 °C, duración 30 s	-	-
59425800	BY581P 250S/840 DIA WB GC SI BR	-30 °C a +55 °C	Temperatura 650 °C, duración 30 s	0,12	0,07
59429600	BY581P 250S/840 DIA HE WB GC SI BR	-30 °C a +55 °C	Temperatura 650 °C, duración 30 s	0,12	0,07
58901800	BY581P 250S/840 DIA ASYM GC SI BR	-30 °C a +55 °C	Temperatura 650 °C, duración 30 s	0,12	0,07
58903200	BY581P 250S/840 DIA HE ASYM GC SI BR	-30 °C a +55 °C	Temperatura 650 °C, duración 30 s	0,12	0,07
58905600	BY581P 250S/840 DIA ASYM GC SI MBW	-30 °C a +55 °C	Temperatura 650 °C, duración 30 s	0,12	0,07
58907000	BY581P 250S/840 DIA HE ASYM GC SI MBW	-30 °C a +55 °C	Temperatura 650 °C, duración 30 s	0,12	0,07
58932200	BY581P 350S/840 DIA HE WB GC SI BR XT 1m	-30 °C a +55 °C	Temperatura 650 °C, duración 30 s	0,22	0,01

Order Code	Full Product Name	Rango de temperatura ambiente	Test del hilo incandescente	Valor de parpadeo (PstLM)	Valor de efecto estroboscópico (SVM)
59424100	BY580P 170S/840 DIA WB GC SI BR	-30 °C a +55 °C	Temperatura 650 °C, duración 30 s	0,12	0,07
59428900	BY580P 170S/840 DIA HE WB GC SI BR	-30 °C a +55 °C	Temperatura 650 °C, duración 30 s	-	-
58902500	BY580P 170S/840 DIA HE ASYM GC SI BR	-30 °C a +55 °C	Temperatura 650 °C, duración 30 s	-	-
59409800	BY581P 250S/840 PSU WB GC SI	-30 °C a +55 °C	Temperatura 650 °C, duración 30 s	0,04	0,07
59411100	BY581P 250S/840 PSU HE WB GC SI	-30 °C a +55 °C	Temperatura 650 °C, duración 30 s	0,04	0,07
59413500	BY581P 200S/840 DIA UE WB GC SI	-30 °C a +55 °C	Temperatura 650 °C, duración 30 s	0,12	0,07
59416600	BY581P 250S/840 DIA WB GC SI	-30 °C a +55 °C	Temperatura 650 °C, duración 30 s	0,12	0,07
59417300	BY581P 350S/840 DIA WB GC SI	-30 °C a +55 °C	Temperatura 650 °C, duración 30 s	0,22	0,01
59420300	BY581P 250S/840 DIA HE WB GC SI	-30 °C a +55 °C	Temperatura 650 °C, duración 30 s	0,12	0,07
59421000	BY581P 350S/840 DIA HE WB GC SI	-30 °C a +55 °C	Temperatura 650 °C, duración 30 s	0,22	0,01
59423400	BY581P 250S/840 DIA WB PC SI	-30 °C a +55 °C	Temperatura 650 °C, duración 30 s	0,12	0,07
59427200	BY581P 250S/840 DIA HE WB PC SI	-30 °C a +55 °C	Temperatura 650 °C, duración 30 s	0,12	0,07

Order Code	Full Product Name	Rango de temperatura ambiente	Test del hilo incandescente	Valor de parpadeo (PstLM)	Valor de efecto estroboscópico (SVM)
59431900	BY581P 250S/840 DIA WB GC SI ELD3	0 °C a 25 °C	Temperatura 850 °C, duración 30 s	0,12	0,07
59433300	BY581P 250S/840 DIA HE WB GC SI ELD3	0 °C a 25 °C	Temperatura 850 °C, duración 30 s	0,12	0,07
59436400	BY581P 250S/840 DIA MB GC SI	-30 °C a +55 °C	Temperatura 650 °C, duración 30 s	0,12	0,07
59437100	BY581P 350S/840 DIA MB GC SI	-30 °C a +55 °C	Temperatura 650 °C, duración 30 s	0,22	0,01
59440100	BY581P 250S/840 DIA HE MB GC SI	-30 °C a +55 °C	Temperatura 650 °C, duración 30 s	0,12	0,07
59441800	BY581P 350S/840 DIA HE MB GC SI	-30 °C a +55 °C	Temperatura 650 °C, duración 30 s	0,22	0,01
58909400	BY581P 250S/840 DIA NB GC SI	-30 °C a +55 °C	Temperatura 650 °C, duración 30 s	0,12	0,07
58911700	BY581P 250S/840 DIA HE NB GC SI	-30 °C a +55 °C	Temperatura 650 °C, duración 30 s	0,12	0,07
58913100	BY581P 250S/840 DIA XNB GC SI	-30 °C a +55 °C	Temperatura 650 °C, duración 30 s	0,12	0,07
58915500	BY581P 250S/840 DIA HE XNB GC SI	-30 °C a +55 °C	Temperatura 650 °C, duración 30 s	0,12	0,07
58917900	BY581P 250S/840 DIA HRO GC SI	-30 °C a +55 °C	Temperatura 650 °C, duración 30 s	0,12	0,07
58919300	BY581P 250S/840 DIA HE HRO GC SI	-30 °C a +55 °C	Temperatura 650 °C, duración 30 s	0,12	0,07

Order Code	Full Product Name	Rango de temperatura ambiente	Test del hilo incandescente	Valor de parpadeo (PstLM)	Valor de efecto estroboscópico (SVM)
58921600	BY581P 250S/865 DIA WB GC SI	-30 °C a +55 °C	Temperatura 650 °C, duración 30 s	0,12	0,07
58923000	BY581P 250S/865 DIA HE WB GC SI	-30 °C a +55 °C	Temperatura 650 °C, duración 30 s	0,12	0,07
58925400	BY581P 250S/830 DIA WB GC SI	-30 °C a +55 °C	Temperatura 650 °C, duración 30 s	0,12	0,07
58927800	BY581P 250S/830 DIA HE WB GC SI	-30 °C a +55 °C	Temperatura 650 °C, duración 30 s	0,12	0,07
58929200	BY581P 250S/940 DIA WB GC SI	-30 °C a +55 °C	Temperatura 650 °C, duración 30 s	0,12	0,07
58930800	BY581P 250S/840 DIA HE WB GC SI XT 1m	-30 °C a 65 °C	Temperatura 650 °C, duración 30 s	0,12	0,07
58931500	BY581P 350S/840 DIA HE WB	-30 °C a 55 °C	Temperatura 650 °C, duración 30 s	0,22	0,01

Order Code	Full Product Name	Rango de temperatura ambiente	Test del hilo incandescente	Valor de parpadeo (PstLM)	Valor de efecto estroboscópico (SVM)
	GC SI XT 1m				
59037300	BY583P 250S/840 DIA HE WB GC SI 0,5m CW5	-30 °C a +55 °C	Temperatura 650 °C, duración 30 s	0,12	0,07
59039700	BY583P 250S/840 DIA HE WB GC SI 1m CW5	-30 °C a +55 °C	Temperatura 650 °C, duración 30 s	0,12	0,07
59392300	BY580X 130S/840 SIA WB GC SI H4	-30 °C a +55 °C	Temperatura 650 °C, duración 30 s	1	0,4
59393000	BY580X 170S/840 SIA WB GC SI H4	-30 °C a +55 °C	Temperatura 650 °C, duración 30 s	1	0,4
59396100	BY580X 130S/840 SIA HE WB GC SI H4	-30 °C a +55 °C	Temperatura 650 °C, duración 30 s	1	0,4
59397800	BY580X 170S/840 SIA HE WB GC SI H4	-30 °C a +55 °C	Temperatura 650 °C, duración 30 s	1	0,4

Rendimiento inicial (conforme con IEC)

Order Code	Full Product Name	Cromaticidad inicial
58949000	BY581P 700S/840 DIA WB GC SI	(0.380, 0.375) SDCM 3
58950600	BY581P 700S/840 DIA HE WB GC SI	(0.383, 0.377) SDCM 3
58951300	BY581P 700S/840 DIA WB GC SI BR	(0.380, 0.375) SDCM 3
58952000	BY581P 700S/840 DIA HE WB GC SI BR	(0.383, 0.377) SDCM 3
59401200	BY581X 250S/840 SIA WB GC SI H4 BR	(0.380, 0.375) SDCM 3
59402900	BY581X 250S/840 SIA HE WB GC SI H4 BR	(0.383, 0.377) SDCM 3
59394700	BY581X 250S/840 SIA WB GC SI H4	(0.380, 0.375) SDCM 3
59395400	BY581X 350S/840 SIA WB GC SI H4	(0.380, 0.375) SDCM 3
59398500	BY581X 250S/840 SIA HE WB GC SI H4	(0.383, 0.377) SDCM 3
59399200	BY581X 350S/840 SIA HE WB GC SI H4	(0.383, 0.377) SDCM 3
59404300	BY581X 250S/840 SIA WB GC SI ELP3 H4	(0.380, 0.375) SDCM 3
59405000	BY581X 250S/840 SIA WB GC SI ELW3 H4	(0.380, 0.375) SDCM 3
59406700	BY581X 250S/840 SIA HE WB GC SI ELP3 H4	(0.383, 0.377) SDCM 3
59407400	BY581X 250S/840 SIA HE WB GC SI ELW3 H4	(0.383, 0.377) SDCM 3
59400500	BY580X 170S/840 SIA WB GC SI H4 BR	(0.380, 0.375) SDCM 3
59403600	BY580X 170S/840 SIA HE WB GC SI H4 BR	(0.383, 0.377) SDCM 3
59408100	BY580P 170S/840 PSU WB GC SI	(0.380, 0.375) SDCM 3
59410400	BY580P 170S/840 PSU HE WB GC SI	(0.383, 0.377) SDCM 3

Order Code	Full Product Name	Cromaticidad inicial
59412800	BY580P 100S/840 DIA UE WB GC SI	(0.383, 0.377) SDCM 3
59414200	BY580P 130S/840 DIA WB GC SI	(0.380, 0.375) SDCM 3
59415900	BY580P 170S/840 DIA WB GC SI	(0.380, 0.375) SDCM 3
59418000	BY580P 130S/840 DIA HE WB GC SI	(0.383, 0.377) SDCM 3
59419700	BY580P 170S/840 DIA HE WB GC SI	(0.383, 0.377) SDCM 3
59422700	BY580P 170S/840 DIA WB PC SI	(0.380, 0.375) SDCM 3
59426500	BY580P 170S/840 DIA HE WB PC SI	(0.383, 0.377) SDCM 3
59430200	BY580P 170S/840 DIA WB GC SI ELP3	(0.380, 0.375) SDCM 3
59432600	BY580P 170S/840 DIA HE WB GC SI ELP3	(0.383, 0.377) SDCM 3
59434000	BY580P 130S/840 DIA MB GC SI	(0.380, 0.375) SDCM 3
59435700	BY580P 170S/840 DIA MB GC SI	(0.380, 0.375) SDCM 3
59438800	BY580P 130S/840 DIA HE MB GC SI	(0.383, 0.377) SDCM 3
59439500	BY580P 170S/840 DIA HE MB GC SI	(0.383, 0.377) SDCM 3
58908700	BY580P 170S/840 DIA NB GC SI	(0.380, 0.375) SDCM 3
58910000	BY580P 170S/840 DIA HE NB GC SI	(0.383, 0.377) SDCM 3
58912400	BY580P 170S/840 DIA XNB GC SI	(0.380, 0.375) SDCM 3
58914800	BY580P 170S/840 DIA HE XNB GC SI	(0.383, 0.377) SDCM 3
58916200	BY580P 170S/840 DIA HRO GC SI	(0.380, 0.375) SDCM 3

Order Code	Full Product Name	Cromaticidad inicial
58918600	BY580P 170S/840 DIA HE HRO GC SI	(0.383, 0.377) SDCM 3
58920900	BY580P 170S/865 DIA WB GC SI	(0.312, 0.327) SDCM 3
58922300	BY580P 170S/865 DIA HE WB GC SI	(0.312, 0.325) SDCM 3
58924700	BY580P 170S/830 DIA WB GC SI	(0.432, 0.400) SDCM 3
58926100	BY580P 170S/830 DIA HE WB GC SI	(0.435, 0.401) SDCM 3
58928500	BY580P 170S/940 DIA WB GC SI	(0.380, 0.375) SDCM 3
59036600	BY582P 170S/840 DIA HE WB GC SI 0.5m CW5	(0.380, 0.375) SDCM 3
59038000	BY582P 170S/840 DIA HE WB GC SI 1m CW5	(0.380, 0.375) SDCM 3
58904900	BY580P 170S/840 DIA ASYM GC SI MBW	(0.380, 0.375) SDCM 3
58906300	BY580P 170S/840 DIA HE ASYM GC SI MBW	(0.383, 0.377) SDCM 3
59425800	BY581P 250S/840 DIA WB GC SI BR	(0.380, 0.375) SDCM 3
59429600	BY581P 250S/840 DIA HE WB GC SI BR	(0.383, 0.377) SDCM 3
58901800	BY581P 250S/840 DIA ASYM GC SI BR	(0.380, 0.375) SDCM 3
58903200	BY581P 250S/840 DIA HE ASYM GC SI BR	(0.383, 0.377) SDCM 3
58905600	BY581P 250S/840 DIA ASYM GC SI MBW	(0.380, 0.375) SDCM 3
58907000	BY581P 250S/840 DIA HE ASYM GC SI MBW	(0.383, 0.377) SDCM 3
58932200	BY581P 350S/840 DIA HE WB GC SI BR XT 1m	(0.383, 0.377) SDCM 3
59424100	BY580P 170S/840 DIA WB GC SI BR	(0.380, 0.375) SDCM 3
59428900	BY580P 170S/840 DIA HE WB GC SI BR	(0.383, 0.377) SDCM 3
58902500	BY580P 170S/840 DIA HE ASYM GC SI BR	(0.383, 0.377) SDCM 3
59409800	BY581P 250S/840 PSU WB GC SI	(0.380, 0.375) SDCM 3
59411100	BY581P 250S/840 PSU HE WB GC SI	(0.383, 0.377) SDCM 3
59413500	BY581P 200S/840 DIA UE WB GC SI	(0.383, 0.377) SDCM 3
59416600	BY581P 250S/840 DIA WB GC SI	(0.380, 0.375) SDCM 3
59417300	BY581P 350S/840 DIA WB GC SI	(0.380, 0.375) SDCM 3
59420300	BY581P 250S/840 DIA HE WB GC SI	(0.383, 0.377) SDCM 3
59421000	BY581P 350S/840 DIA HE WB GC SI	(0.383, 0.377) SDCM 3

Order Code	Full Product Name	Cromaticidad inicial
59423400	BY581P 250S/840 DIA WB PC SI	(0.380, 0.375) SDCM 3
59427200	BY581P 250S/840 DIA HE WB PC SI	(0.383, 0.377) SDCM 3
59431900	BY581P 250S/840 DIA WB GC SI ELD3	(0.380, 0.375) SDCM 3
59433300	BY581P 250S/840 DIA HE WB GC SI ELD3	(0.383, 0.377) SDCM 3
59436400	BY581P 250S/840 DIA MB GC SI	(0.380, 0.375) SDCM 3
59437100	BY581P 350S/840 DIA MB GC SI	(0.380, 0.375) SDCM 3
59440100	BY581P 250S/840 DIA HE MB GC SI	(0.383, 0.377) SDCM 3
59441800	BY581P 350S/840 DIA HE MB GC SI	(0.383, 0.377) SDCM 3
58909400	BY581P 250S/840 DIA NB GC SI	(0.380, 0.375) SDCM 3
58911700	BY581P 250S/840 DIA HE NB GC SI	(0.383, 0.377) SDCM 3
58913100	BY581P 250S/840 DIA XNB GC SI	(0.380, 0.375) SDCM 3
58915500	BY581P 250S/840 DIA HE XNB GC SI	(0.383, 0.377) SDCM 3
58917900	BY581P 250S/840 DIA HRO GC SI	(0.380, 0.375) SDCM 3
58919300	BY581P 250S/840 DIA HE HRO GC SI	(0.383, 0.377) SDCM 3
58921600	BY581P 250S/865 DIA WB GC SI	(0.312, 0.327) SDCM 3
58923000	BY581P 250S/865 DIA HE WB GC SI	(0.312, 0.325) SDCM 3
58925400	BY581P 250S/830 DIA WB GC SI	(0.432, 0.400) SDCM 3
58927800	BY581P 250S/830 DIA HE WB GC SI	(0.435, 0.401) SDCM 3
58929200	BY581P 250S/940 DIA WB GC SI	(0.380, 0.375) SDCM 3
58930800	BY581P 250S/840 DIA HE WB GC SI XT 1m	(0.383, 0.377) SDCM 3
58931500	BY581P 350S/840 DIA HE WB GC SI XT 1m	(0.383, 0.377) SDCM 3
59037300	BY583P 250S/840 DIA HE WB GC SI 0.5m CW5	(0.380, 0.375) SDCM 3
59039700	BY583P 250S/840 DIA HE WB GC SI 1m CW5	(0.380, 0.375) SDCM 3
59392300	BY580X 130S/840 SIA WB GC SI H4	(0.380, 0.375) SDCM 3
59393000	BY580X 170S/840 SIA WB GC SI H4	(0.380, 0.375) SDCM 3
59396100	BY580X 130S/840 SIA HE WB GC SI H4	(0.383, 0.377) SDCM 3
59397800	BY580X 170S/840 SIA HE WB GC SI H4	(0.383, 0.377) SDCM 3

Datos de producto

Order Code	Full Product Name	Código de gama de producto
58949000	BY581P 700S/840 DIA WB GC SI	BY581P
58950600	BY581P 700S/840 DIA HE WB GC SI	BY581P
58951300	BY581P 700S/840 DIA WB GC SI BR	BY581P
58952000	BY581P 700S/840 DIA HE WB GC SI BR	BY581P
59401200	BY581X 250S/840 SIA WB GC SI H4 BR	BY580X
59402900	BY581X 250S/840 SIA HE WB GC SI H4 BR	BY581X
59394700	BY581X 250S/840 SIA WB GC SI H4	BY580X
59395400	BY581X 350S/840 SIA WB GC SI H4	BY581X
59398500	BY581X 250S/840 SIA HE WB GC SI H4	BY581X
59399200	BY581X 350S/840 SIA HE WB GC SI H4	BY581X
59404300	BY581X 250S/840 SIA WB GC SI ELP3 H4	BY581X
59405000	BY581X 250S/840 SIA WB GC SI ELW3 H4	BY581X
59406700	BY581X 250S/840 SIA HE WB GC SI ELP3 H4	BY581X
59407400	BY581X 250S/840 SIA HE WB GC SI ELW3 H4	BY581X
59400500	BY580X 170S/840 SIA WB GC SI H4 BR	BY580X
59403600	BY580X 170S/840 SIA HE WB GC SI H4 BR	BY580X
59408100	BY580P 170S/840 PSU WB GC SI	BY580P
59410400	BY580P 170S/840 PSU HE WB GC SI	BY580P
59412800	BY580P 100S/840 DIA UE WB GC SI	BY580P
59414200	BY580P 130S/840 DIA WB GC SI	BY580P

Order Code	Full Product Name	Código de gama de producto
59415900	BY580P 170S/840 DIA WB GC SI	BY580P
59418000	BY580P 130S/840 DIA HE WB GC SI	BY580P
59419700	BY580P 170S/840 DIA HE WB GC SI	BY580P
59422700	BY580P 170S/840 DIA WB PC SI	BY580P
59426500	BY580P 170S/840 DIA HE WB PC SI	BY580P
59430200	BY580P 170S/840 DIA WB GC SI ELP3	BY580P
59432600	BY580P 170S/840 DIA HE WB GC SI ELP3	BY580P
59434000	BY580P 130S/840 DIA MB GC SI	BY580P
59435700	BY580P 170S/840 DIA MB GC SI	BY580P
59438800	BY580P 130S/840 DIA HE MB GC SI	BY580P
59439500	BY580P 170S/840 DIA HE MB GC SI	BY580P
58908700	BY580P 170S/840 DIA NB GC SI	BY580P
58910000	BY580P 170S/840 DIA HE NB GC SI	BY580P
58912400	BY580P 170S/840 DIA XNB GC SI	BY580P
58914800	BY580P 170S/840 DIA HE XNB GC SI	BY580P
58916200	BY580P 170S/840 DIA HRO GC SI	BY580P
58918600	BY580P 170S/840 DIA HE HRO GC SI	BY580P
58920900	BY580P 170S/865 DIA WB GC SI	BY580P
58922300	BY580P 170S/865 DIA HE WB GC SI	BY580P
58924700	BY580P 170S/830 DIA WB GC SI	BY580P

Order Code	Full Product Name	Código de gama de producto
58926100	BY580P 170S/830 DIA HE WB GC SI	BY580P
58928500	BY580P 170S/940 DIA WB GC SI	BY580P
59036600	BY582P 170S/840 DIA HE WB GC SI 0.5m CW5	BY582P
59038000	BY582P 170S/840 DIA HE WB GC SI 1m CW5	BY582P
58904900	BY580P 170S/840 DIA ASYM GC SI MBW	BY580P
58906300	BY580P 170S/840 DIA HE ASYM GC SI MBW	BY580P
59425800	BY581P 250S/840 DIA WB GC SI BR	BY581P
59429600	BY581P 250S/840 DIA HE WB GC SI BR	BY581P
58901800	BY581P 250S/840 DIA ASYM GC SI BR	BY581P
58903200	BY581P 250S/840 DIA HE ASYM GC SI BR	BY581P
58905600	BY581P 250S/840 DIA ASYM GC SI MBW	BY581P
58907000	BY581P 250S/840 DIA HE ASYM GC SI MBW	BY581P
58932200	BY581P 350S/840 DIA HE WB GC SI BR XT 1m	BY581P
59424100	BY580P 170S/840 DIA WB GC SI BR	BY580P
59428900	BY580P 170S/840 DIA HE WB GC SI BR	BY580P
58902500	BY580P 170S/840 DIA HE ASYM GC SI BR	BY580P
59409800	BY581P 250S/840 PSU WB GC SI	BY581P
59411100	BY581P 250S/840 PSU HE WB GC SI	BY581P
59413500	BY581P 200S/840 DIA UE WB GC SI	BY581P
59416600	BY581P 250S/840 DIA WB GC SI	BY581P
59417300	BY581P 350S/840 DIA WB GC SI	BY581P
59420300	BY581P 250S/840 DIA HE WB GC SI	BY581P
59421000	BY581P 350S/840 DIA HE WB GC SI	BY581P
59423400	BY581P 250S/840 DIA WB PC SI	BY581P
59427200	BY581P 250S/840 DIA HE WB PC SI	BY581P

Order Code	Full Product Name	Código de gama de producto
59431900	BY581P 250S/840 DIA WB GC SI ELD3	BY581P
59433300	BY581P 250S/840 DIA HE WB GC SI ELD3	BY581P
59436400	BY581P 250S/840 DIA MB GC SI	BY581P
59437100	BY581P 350S/840 DIA MB GC SI	BY581P
59440100	BY581P 250S/840 DIA HE MB GC SI	BY581P
59441800	BY581P 350S/840 DIA HE MB GC SI	BY581P
58909400	BY581P 250S/840 DIA NB GC SI	BY581P
58911700	BY581P 250S/840 DIA HE NB GC SI	BY581P
58913100	BY581P 250S/840 DIA XNB GC SI	BY581P
58915500	BY581P 250S/840 DIA HE XNB GC SI	BY581P
58917900	BY581P 250S/840 DIA HRO GC SI	BY581P
58919300	BY581P 250S/840 DIA HE HRO GC SI	BY581P
58921600	BY581P 250S/865 DIA WB GC SI	BY581P
58923000	BY581P 250S/865 DIA HE WB GC SI	BY581P
58925400	BY581P 250S/830 DIA WB GC SI	BY581P
58927800	BY581P 250S/830 DIA HE WB GC SI	BY581P
58929200	BY581P 250S/940 DIA WB GC SI	BY581P
58930800	BY581P 250S/840 DIA HE WB GC SI XT 1m	BY581P
58931500	BY581P 350S/840 DIA HE WB GC SI XT 1m	BY581P
59037300	BY583P 250S/840 DIA HE WB GC SI 0.5m CW5	BY583P
59039700	BY583P 250S/840 DIA HE WB GC SI 1m CW5	BY583P
59392300	BY580X 130S/840 SIA WB GC SI H4	BY580X
59393000	BY580X 170S/840 SIA WB GC SI H4	BY580X
59396100	BY580X 130S/840 SIA HE WB GC SI H4	BY580X
59397800	BY580X 170S/840 SIA HE WB GC SI H4	BY580X

Polar Wide Diagrams

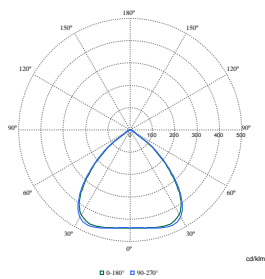

Polar Normal (separate) - BY580PI -
910505104540

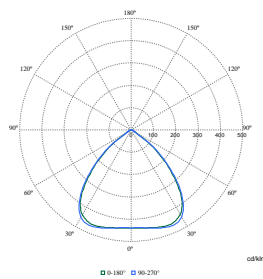

Polar Normal (separate) - BY580PI -
910505104542

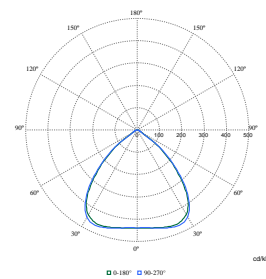

Polar Normal (separate) - BY580PI -
910505104541

Polar Wide Diagrams

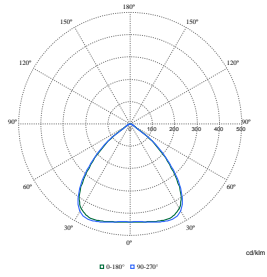

Polar Normal (separate) - BY580PI - 910505104543

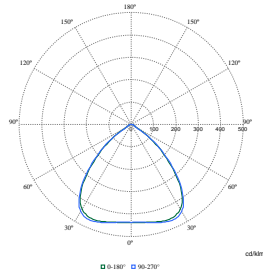

Polar Normal (separate) - BY580PI - 910505102872

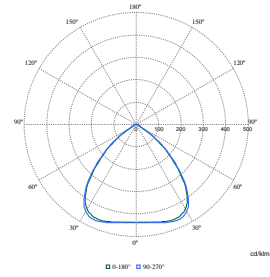

Polar Normal (separate) - BY580PI - 910505102863

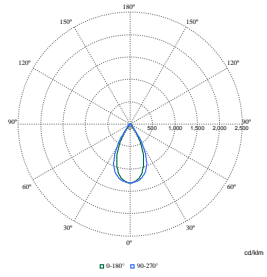

Polar Normal (separate) - BY580PI - 910505102914

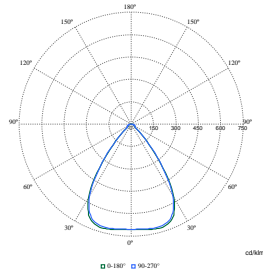

Polar Normal (separate) - BY580PI - 910505102899

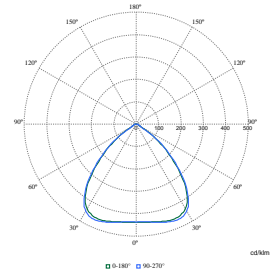

Polar Normal (separate) - BY580PI - 910505102869

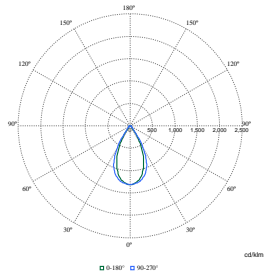

Polar Normal (separate) - BY580PI - 910505102915

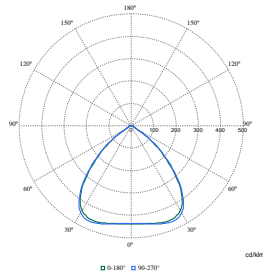

Polar Normal (separate) - BY580PI - 910505102865

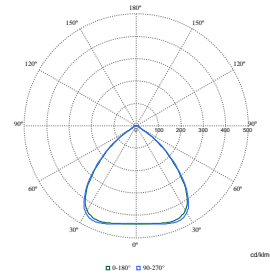

Polar Normal (separate) - BY580PI - 910505102895

Polar Wide Diagrams

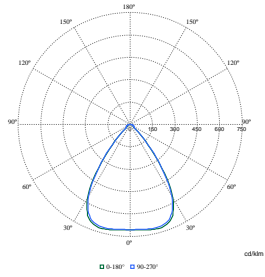

Polar Normal (separate) - BY580PI - 910505102898

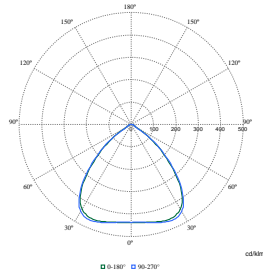

Polar Normal (separate) - BY580PI - 910505102856

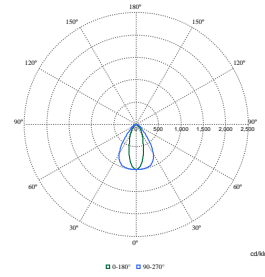

Polar Normal (separate) - BY580PI - 910505102924

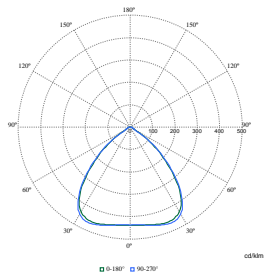

Polar Normal (separate) - BY580PI - 910505102881

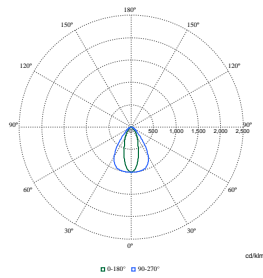

Polar Normal (separate) - BY580PI - 910505102925

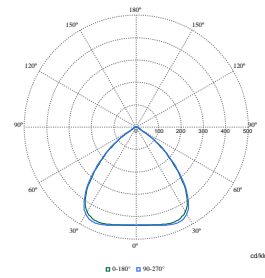

Polar Normal (separate) - BY580PI - 910505102857

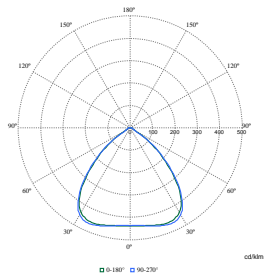

Polar Normal (separate) - BY580PI - 910505102933

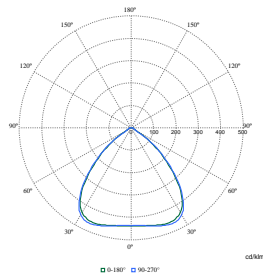

Polar Normal (separate) - BY580PI - 910505102873

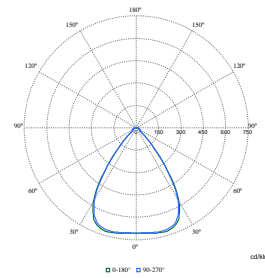

Polar Normal (separate) - BY580PI - 910505102902

Polar Wide Diagrams

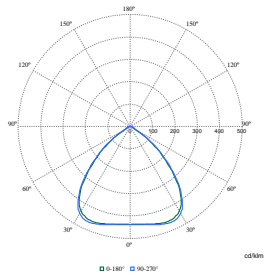

Polar Normal (separate) - BY580PI - 910505102884

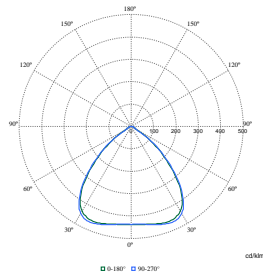

Polar Normal (separate) - BY580PI - 910505102874

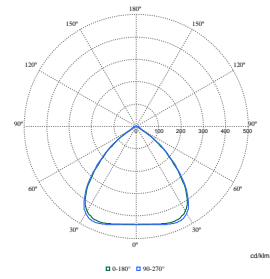

Polar Normal (separate) - BY580PI - 910505102896

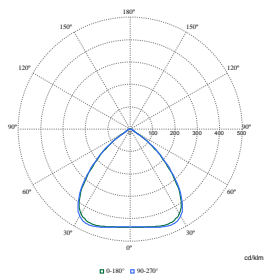

Polar Normal (separate) - BY580PI - 910505102875

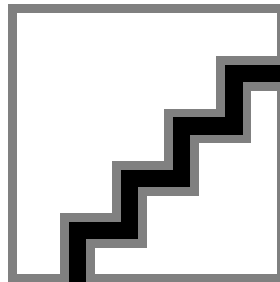

Polar Normal (separate) - BY580PI - 910505102868

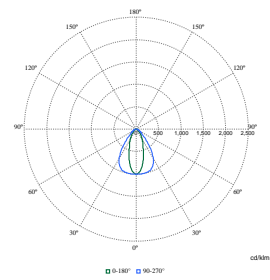

Polar Normal (separate) - BY580PI - 910505102923

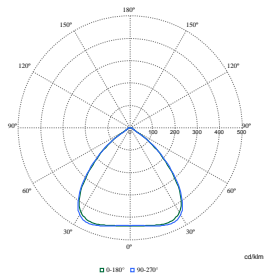

Polar Normal (separate) - BY580PI - 910505102858

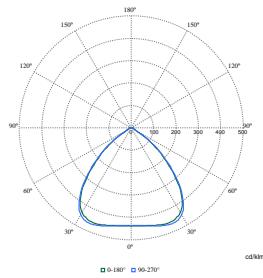

Polar Normal (separate) - BY580PI - 910505102871

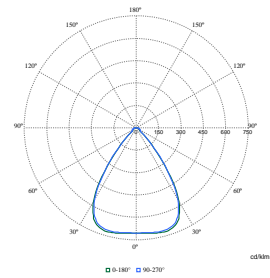

Polar Normal (separate) - BY580PI - 910505102901

Polar Wide Diagrams

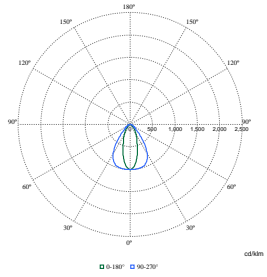

Polar Normal (separate) - BY580PI - 910505102922

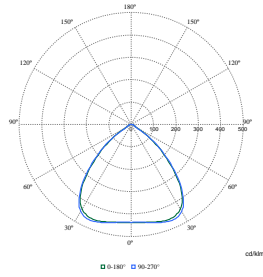

Polar Normal (separate) - BY580PI - 910505102862

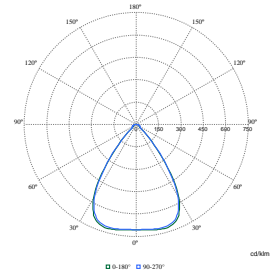

Polar Normal (separate) - BY580PI - 910505102906

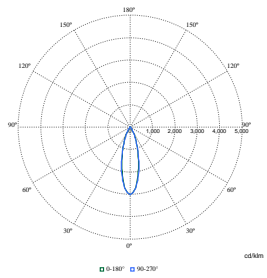

Polar Normal (separate) - BY580PI - 910505102921

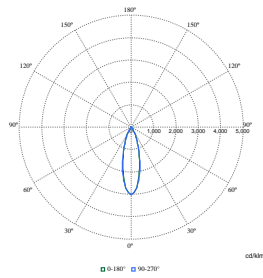

Polar Normal (separate) - BY580PI - 910505102920

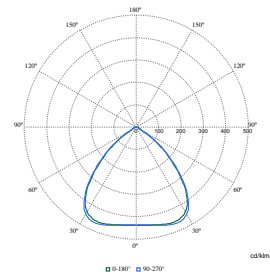

Polar Normal (separate) - BY580PI - 910505102932

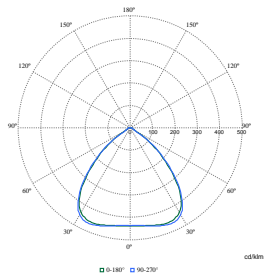

Polar Normal (separate) - BY580PI - 910505102864

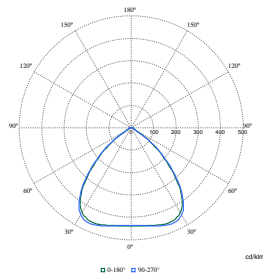

Polar Normal (separate) - BY580PI - 910505102934

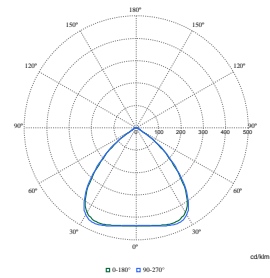

Polar Normal (separate) - BY580PI - 910505102878

Polar Wide Diagrams

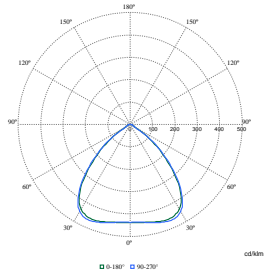

Polar Normal (separate) - BY580PI - 910505102866

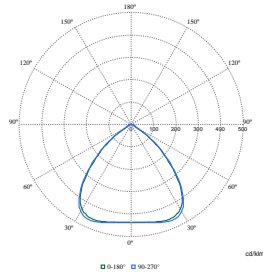

Polar Normal (separate) - BY580PI - 910505102885

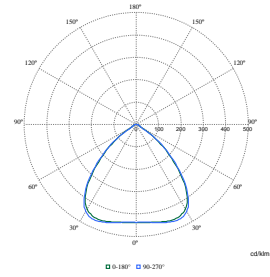

Polar Normal (separate) - BY580PI - 910505102883

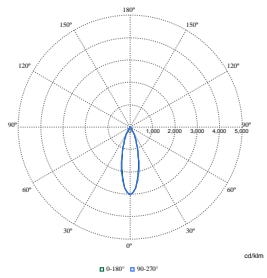

Polar Normal (separate) - BY580PI - 910505102918

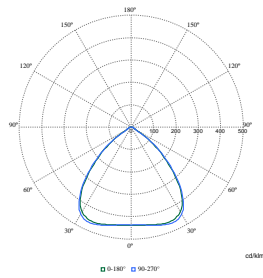

Polar Normal (separate) - BY580PI - 910505102882

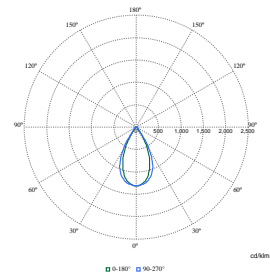

Polar Normal (separate) - BY580PI - 910505102916

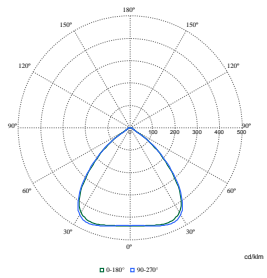

Polar Normal (separate) - BY580PI - 910505102926

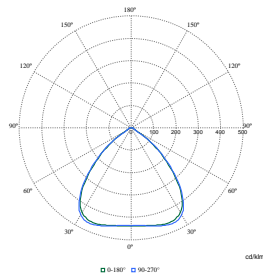

Polar Normal (separate) - BY580PI - 910505102928

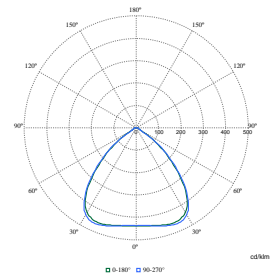

Polar Normal (separate) - BY580PI - 910505102935

Polar Wide Diagrams

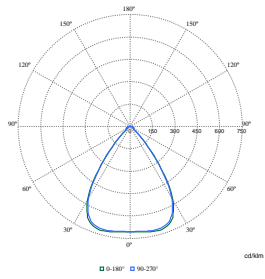

Polar Normal (separate) - BY580PI - 910505102903

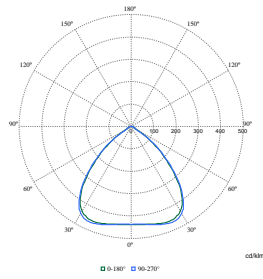

Polar Normal (separate) - BY580PI - 910505102891

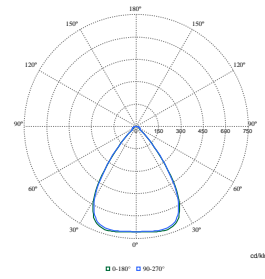

Polar Normal (separate) - BY580PI - 910505102904

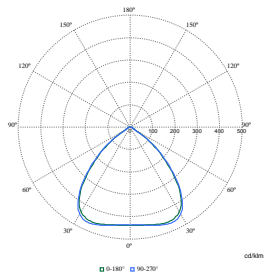

Polar Normal (separate) - BY580PI - 910505102886

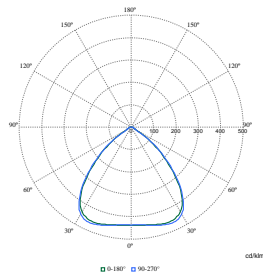

Polar Normal (separate) - BY580PI - 910505102867

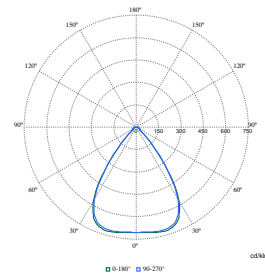

Polar Normal (separate) - BY580PI - 910505102905

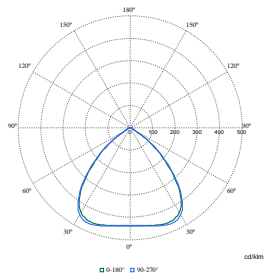

Polar Normal (separate) - BY580PI - 910505102890

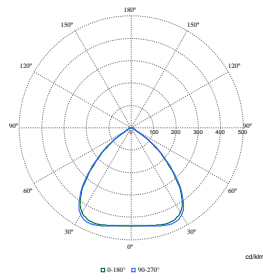

Polar Normal (separate) - BY580PI - 910505102894

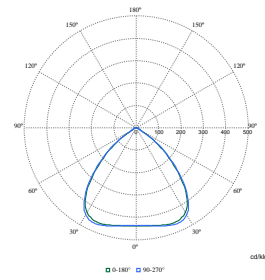

Polar Normal (separate) - BY580PI - 910505102930

Polar Wide Diagrams

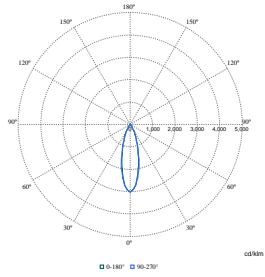

Polar Normal (separate) - BY580PI - 910505102919

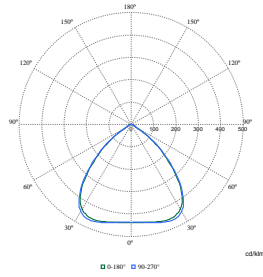

Polar Normal (separate) - BY580PI - 910505102879

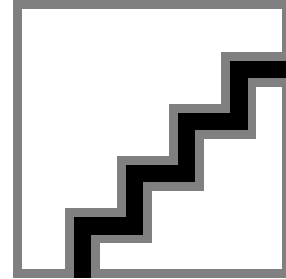

Polar Normal (separate) - BY580PI - 910505102870

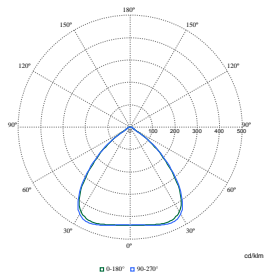

Polar Normal (separate) - BY580PI - 910505102887

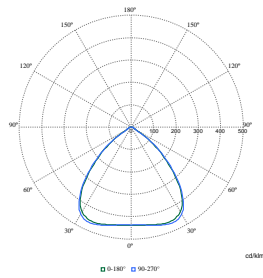

Polar Normal (separate) - BY580PI - 910505102859

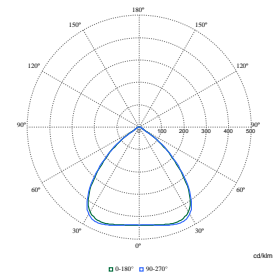

Polar Normal (separate) - BY580PI - 910505102892

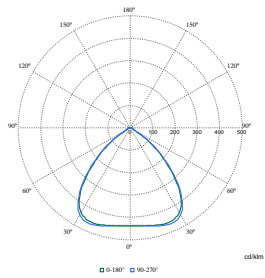

Polar Normal (separate) - BY580PI - 910505102893

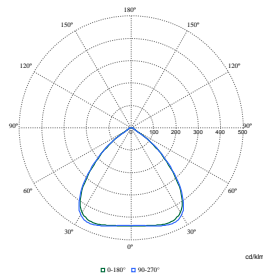

Polar Normal (separate) - BY580PI - 910505102860

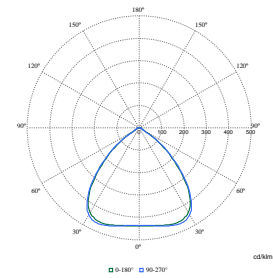

Polar Normal (separate) - BY580PI - 910505102929

Polar Wide Diagrams

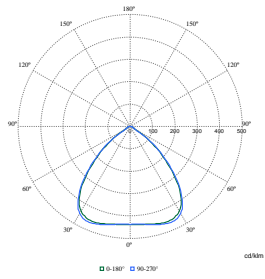

Polar Normal (separate) - BY580PI - 910505102931

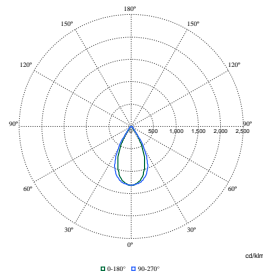

Polar Normal (separate) - BY580PI - 910505102917

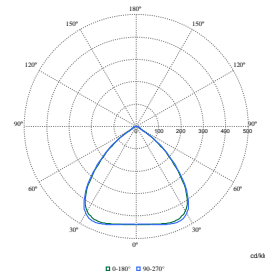

Polar Normal (separate) - BY580PI - 910505102877

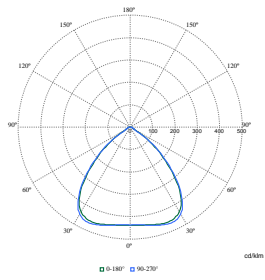

Polar Normal (separate) - BY580PI - 910505102889

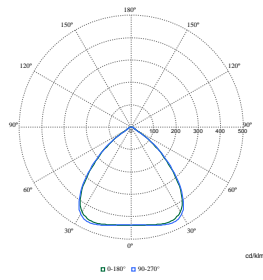

Polar Normal (separate) - BY580PI - 910505102927

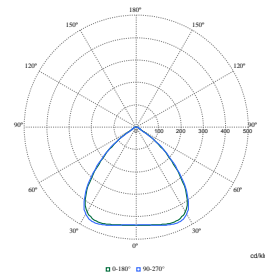

Polar Normal (separate) - BY580PI - 910505102861

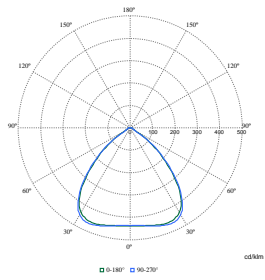

Polar Normal (separate) - BY580PI - 910505102888

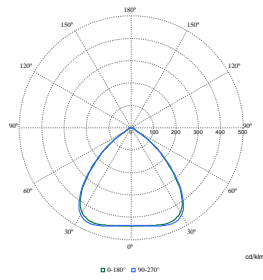

Polar Normal (separate) - BY580PI - 910505102880

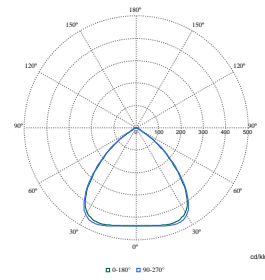

Polar Normal (separate) - BY580PI - 910505102897

Polar Wide Diagrams

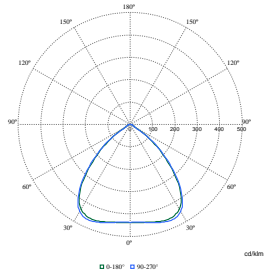

Polar Normal (separate) - BY580PI - 910505102876

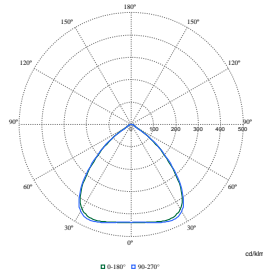

Polar Normal (separate) - BY580PI - 910505102938

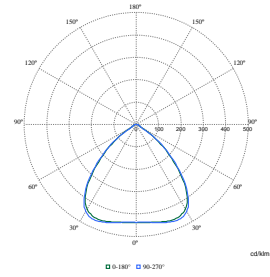

Polar Normal (separate) - BY580PI - 910505102936

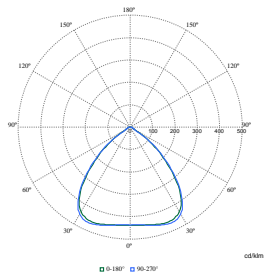

Polar Normal (separate) - BY580PI - 910505102937

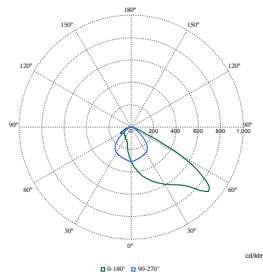

Polar Normal (separate) - BY580PI - 910505102907

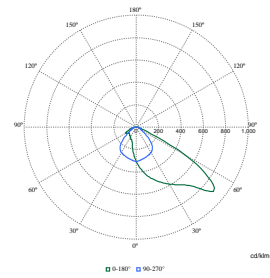

Polar Normal (separate) - BY580PI - 910505102913

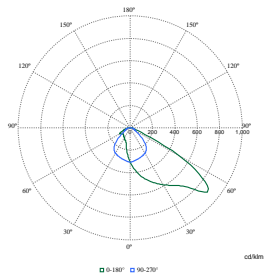

Polar Normal (separate) - BY580PI - 910505102912

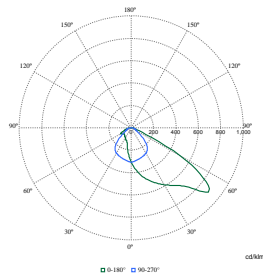

Polar Normal (separate) - BY580PI - 910505102909

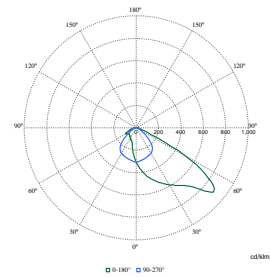

Polar Normal (separate) - BY580PI - 910505102908

Polar Wide Diagrams

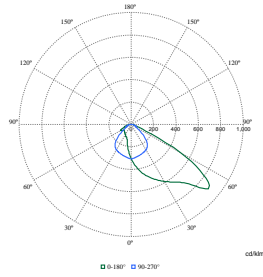
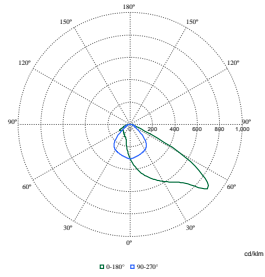

Polar Normal (separate) - BY580PI - 910505102910

Polar Normal (separate) - BY580PI - 910505102911

