



# GentleSpace – High-quality, efficient lighting engineered for excellence in tough environments

## GentleSpace gen4

GentleSpace gen4 is the ultimate lighting solution for industrial settings and indoor sports facilities. It exceeds expectations by ensuring superior light quality, improving employee safety and productivity, and complying with all the relevant safety regulations. Engineered for longevity, GentleSpace gen4 reduces the frequency, hassle, and costs of maintenance, making it ideal for high-ceiling installations. Its energy-efficient design cuts operational expenses, offering maximum application efficiency and an attractive total cost of ownership (TCO). This product range offers a wide variety of optics, beam angles (from very narrow to wide), lumen packages, and connectivity options. With GentleSpace gen4 you can easily create a tailor-made lighting solution for every high-ceiling application. Its modern, flat design makes it easier to install, clean, and maintain. The single optical window design provides superior visual performance. A variety of mounting possibilities and connectors, like the pre-mounted IP65 connector, enable quick and easy installation. The robust design allows to withstand harsh conditions in all sorts of environments. You can choose between various cover materials, including specialized variants for extreme temperatures (XT), hazardous areas (ATEX 2/22), and sports applications. Additionally, GentleSpace gen4 offers advanced connectivity options. It's ready to use in connected lighting systems like Interact. Reliable, high-efficiency lighting with smart connectivity – a bright choice for a better future. Embrace sustainability with GentleSpace gen4, the highbay lighting solution that complies with the principles of the circular economy by prioritizing durability and recyclability. The luminaire is serviceable, with all the information available at your fingertips via the Signify Service tag app. Whether you are looking

## GentleSpace gen4

for a reliable “fit and forget” solution or one that can be adapted and controlled after installation, GentleSpace gen4 is the right choice for you.

### Benefits

- Robust design, created to withstand harsh conditions in all sorts of environments
- Compact product architecture, resistant to high impact (IK08), water, and dust (IP65)
- Excellent light uniformity and low glare for optimized working conditions with improved safety and greater visual comfort
- Attractive total cost of ownership thanks to its high luminous efficacy (up to 189 lm/W), long lifetime (100,000 hours @L85), and optimized lighting plan that requires fewer luminaires per application
- Easy installation. Single-piece, lighter architecture (approximately 20% lighter than the previous generation) with multiple mounting options for flexible installation in various environments and conditions
- Interact Ready connectivity for smart lighting. Connect to the cloud and discover additional ways to save energy through optimized efficiency, motion sensing and daylight harvesting, as well as improved lighting management, productivity, and safety
- Engineered with sustainability in mind. Meets lighting for circularity criteria to help you achieve your sustainability goals

### Features

- Exceptional performance with UltraEfficient (UE, 189 lm/W) and High-Efficiency (HE, 183 lm/W) versions
- Long service life of 100,000 hours at L85
- High water (IP65) and impact protection (IK08)
- Wide variety of optics (wide beam/medium beam/narrow beam/extra narrow beam/high-rack/asymmetrical)
- Special options for a broad range of applications: Extreme version (XT) up to 70°C, Safety Class I or II, swimming pool protected version (SWP), marine protection (MSP), VDE certified ball-proof (BP) option, ATEX 2/22 certified version. Tested against a broad list of chemical substances that may be present in industrial settings
- Detachable mounting system for easy installation, including various mounting options and connectors (IP65 pre-mounted connector, or fly-wire cable)
- Robust, die-cast aluminum housing with efficient thermal management and flat front and rear design for easy installation, cleaning, and maintenance
- Single LED module design for superior light quality
- Access to the Signify Service tag app with service and maintenance information

### Application

- Manufacturing sites (from food and beverage to heavy industry)
- Warehouses and logistics centers
- Indoor sports facilities, swimming pools, and exhibition halls

# GentleSpace gen4

## Versions



GentleSpace gen4-large, suspension



GentleSpace gen4-large, bracket, Interact ready



GentleSpace gen4-small, bracket, Interact ready



GentleSpace gen4-large, wall-bracket



GentleSpace gen4-small, bracket



GentleSpace gen4



GentleSpace gen4-small, wall-bracket

## Dimensional drawing

BY580X suspended

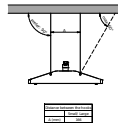
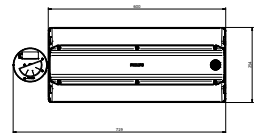

With Wieland connector on a cable or free cable finish, cable length is 0.5m or 1m or 1.5m, or 2m

700s suspended

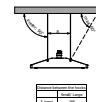
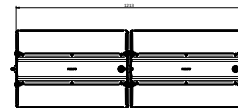
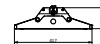

With Wieland connector on a cable or free cable finish, cable length is 0.5m or 1m or 1.5m, or 2m

Dimensional drawing

BY581X suspended

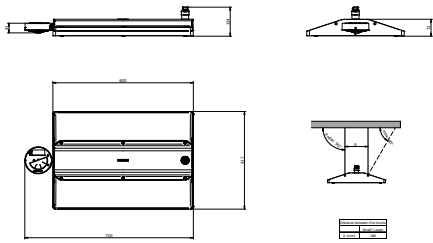

With Wieland connector on a cable or free cable finish, cable length is: 0.5m or 1m or 1.5m, or 2m

BY580P, BY582P suspended

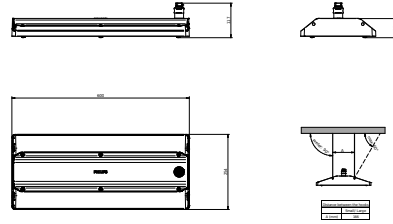

With Wieland connector on a cable or free cable finish, cable length is: 0.5m or 1m or 1.5m, or 2m

BY581P, BY583P Bracket

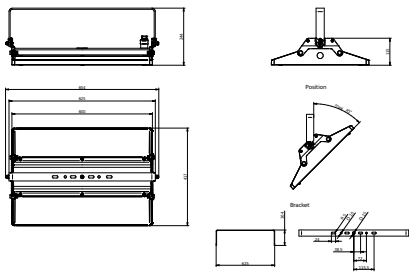

With Wieland connector on a cable or free cable finish, cable length is: 0.5m or 1m or 1.5m, or 2m

BY580P, BY582P Wallmounted bracket

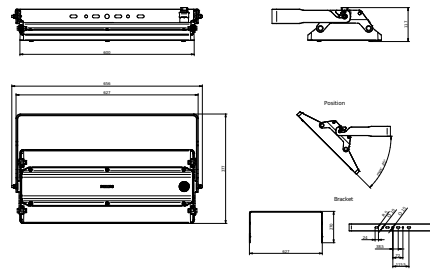

With Wieland connector on a cable or free cable finish, cable length is: 0.5m or 1m or 1.5m, or 2m

BY580P, BY582P Bracket

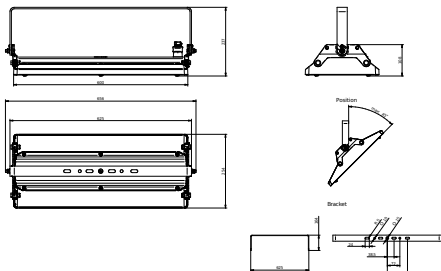

With Wieland connector on a cable or free cable finish, cable length is: 0.5m or 1m or 1.5m, or 2m

BY581X Bracket

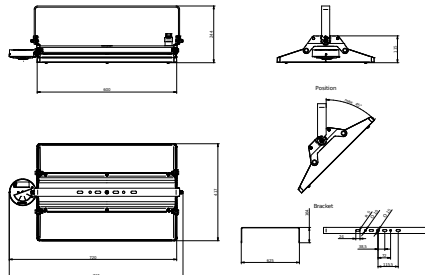

With Wieland connector on a cable or free cable finish, cable length is: 0.5m or 1m or 1.5m, or 2m

BY580X Bracket

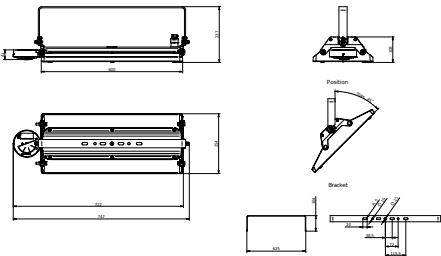

With Wieland connector on a cable or free cable finish, cable length is: 0.5m or 1m or 1.5m, or 2m

BY581P, BY583P Wallmounted bracket

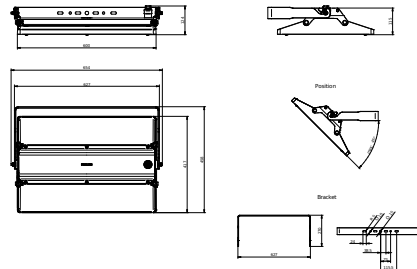

With Wieland connector on a cable or free cable finish, cable length is: 0.5m or 1m or 1.5m, or 2m

# GentleSpace gen4

## Dimensional drawing

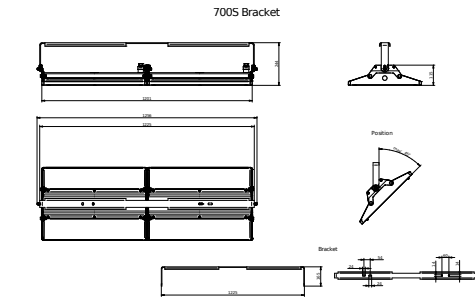

With Wieland connector on a cable or free cable finish, cable length is: 0.5m or 2m or 2.5m, or 2m

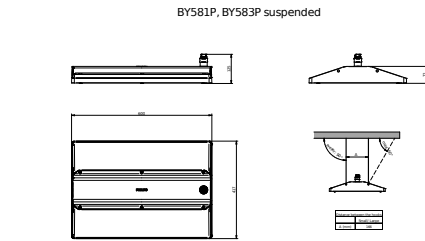

With Wieland connector on a cable or free cable finish, cable length is: 0.5m or 2m or 2.5m, or 2m

## Product details

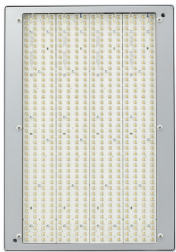

GentleSpace gen4-large, suspension

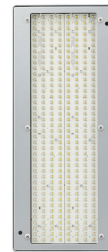

GentleSpace gen4-small, suspension

### General Information

Driver included	Yes
Number of gear units	1 unit
<b>Operating and Electrical</b>	
Protection class IEC	Safety class I
Input Voltage	220 to 240 V
Line Frequency	50 to 60 Hz
<b>Mechanical and Housing</b>	
Housing Color	Silver
Ingress protection code	IP65
<b>Emergency Operation</b>	
Central Emergency	No
<b>Approval and Application</b>	
CE mark	Yes
ENEC mark	ENEC mark
Flammability mark	For mounting on easily flammable surfaces
<b>Initial Performance (IEC Compliant)</b>	
Luminous flux tolerance	+/-10%

### General Information

Order Code	Full Product Name	Service tag
910505102953	BY581P 700S/840 DIA WB GC SI	Yes
910505102954	BY581P 700S/840 DIA HE WB GC SI	Yes
910505102955	BY581P 700S/840 DIA WB GC SI BR	Yes
910505102956	BY581P 700S/840 DIA HE WB GC SI BR	Yes
910505102865	BY581X 250S/840 SIA WB GC SI H4 BR	Yes
910505102866	BY581X 250S/840 SIA HE WB GC SI H4 BR	Yes
910505102858	BY581X 250S/840 SIA WB GC SI H4	Yes
910505102859	BY581X 350S/840 SIA WB GC SI H4	Yes
910505102862	BY581X 250S/840 SIA HE WB GC SI H4	Yes
910505102863	BY581X 350S/840 SIA HE WB GC SI H4	Yes
910505102868	BY581X 250S/840 SIA WB GC SI ELP3 H4	Yes
910505102869	BY581X 250S/840 SIA WB GC SI ELW3 H4	Yes
910505102870	BY581X 250S/840 SIA HE WB GC SI ELP3 H4	Yes
910505102871	BY581X 250S/840 SIA HE WB GC SI ELW3 H4	Yes
910505102864	BY580X 170S/840 SIA WB GC SI H4 BR	Yes
910505102867	BY580X 170S/840 SIA HE WB GC SI H4 BR	Yes
910505104565	BY581P 250S/840 DIA HEWBGCSCHEMMBW1mCW5	-
910505102872	BY580P 170S/840 PSU WB GC SI	Yes
910505102874	BY580P 170S/840 PSU HE WB GC SI	Yes
910505102876	BY580P 100S/840 DIA UE WB GC SI	-
910505102878	BY580P 130S/840 DIA WB GC SI	Yes
910505102879	BY580P 170S/840 DIA WB GC SI	Yes

Order Code	Full Product Name	Service tag
910505102882	BY580P 130S/840 DIA HE WB GC SI	Yes
910505102883	BY580P 170S/840 DIA HE WB GC SI	Yes
910505102886	BY580P 170S/840 DIA WB PC SI	Yes
910505102890	BY580P 170S/840 DIA HE WB PC SI	Yes
910505102894	BY580P 170S/840 DIA WB GC SI ELP3	Yes
910505102896	BY580P 170S/840 DIA HE WB GC SI ELP3	Yes
910505102898	BY580P 130S/840 DIA MB GC SI	Yes
910505102899	BY580P 170S/840 DIA MB GC SI	Yes
910505102903	BY580P 130S/840 DIA HE MB GC SI	Yes
910505102904	BY580P 170S/840 DIA HE MB GC SI	Yes
910505102914	BY580P 170S/840 DIA NB GC SI	Yes
910505102916	BY580P 170S/840 DIA HE NB GC SI	Yes
910505102918	BY580P 170S/840 DIA XNB GC SI	-
910505102920	BY580P 170S/840 DIA HE XNB GC SI	-
910505102922	BY580P 170S/840 DIA HRO GC SI	Yes
910505102924	BY580P 170S/840 DIA HE HRO GC SI	Yes
910505102926	BY580P 170S/865 DIA WB GC SI	Yes
910505102928	BY580P 170S/865 DIA HE WB GC SI	Yes
910505102930	BY580P 170S/830 DIA WB GC SI	Yes
910505102932	BY580P 170S/830 DIA HE WB GC SI	Yes
910505102934	BY580P 170S/940 DIA WB GC SI	Yes
910505104558	BY580X 170S/840 SIA WB GC SI IA9	-
910505104560	BY580X 170S/840 SIA HE WB GC SI ELP3 IA9	-
910505102910	BY580P 170S/840 DIA ASYM GC SI MBW	-
910505102912	BY580P 170S/840 DIA HE ASYM GC SI MBW	-
910505102889	BY581P 250S/840 DIA WB GC SI BR	Yes
910505102893	BY581P 250S/840 DIA HE WB GC SI BR	Yes
910505102907	BY581P 250S/840 DIA ASYM GC SI BR	-
910505102909	BY581P 250S/840 DIA HE ASYM GC SI BR	-
910505102911	BY581P 250S/840 DIA ASYM GC SI MBW	-
910505102913	BY581P 250S/840 DIA HE ASYM GC SI MBW	-
910505102938	BY581P 350S/840 DIA HE WB GC SI BR XT 1m	-
910505104551	BY581P 250S/840 DIA HE WB GC SI MSP BR	-
910505104559	BY581X 250S/840 SIA WB GC SI IA9	-
910505104561	BY581X 250S/840 SIA HE WB GC SI ELP3 IA9	-
910505104563	BY581P 250S/840 DIA HE WBGCSICHEMBR1mCW5	-
910505102888	BY580P 170S/840 DIA WB GC SI BR	Yes
910505102892	BY580P 170S/840 DIA HE WB GC SI BR	Yes
910505102908	BY580P 170S/840 DIA HE ASYM GC SI BR	-
910505104550	BY580P 170S/840 DIA HE WB GC SI MSP BR	-
910505104562	BY580P 170S/840 DIA HE WBGCSICHEMBR1mCW5	-
910505104564	BY580P 170S/840 DIA HEWBGCSICHEMMBW1mCW5	-
910505102873	BY581P 250S/840 PSU WB GC SI	Yes
910505102875	BY581P 250S/840 PSU HE WB GC SI	Yes
910505102877	BY581P 200S/840 DIA UE WB GC SI	-
910505102880	BY581P 250S/840 DIA WB GC SI	Yes
910505102881	BY581P 350S/840 DIA WB GC SI	Yes
910505102884	BY581P 250S/840 DIA HE WB GC SI	Yes
910505102885	BY581P 350S/840 DIA HE WB GC SI	Yes
910505102887	BY581P 250S/840 DIA WB PC SI	Yes
910505102891	BY581P 250S/840 DIA HE WB PC SI	Yes
910505102895	BY581P 250S/840 DIA WB GC SI ELD3	Yes

Order Code	Full Product Name	Service tag
910505102897	BY581P 250S/840 DIA HE WB GC SI ELD3	Yes
910505102901	BY581P 250S/840 DIA MB GC SI	Yes
910505102902	BY581P 350S/840 DIA MB GC SI	Yes
910505102905	BY581P 250S/840 DIA HE MB GC SI	Yes
910505102906	BY581P 350S/840 DIA HE MB GC SI	Yes
910505102915	BY581P 250S/840 DIA NB GC SI	Yes
910505102917	BY581P 250S/840 DIA HE NB GC SI	Yes
910505102919	BY581P 250S/840 DIA XNB GC SI	-
910505102921	BY581P 250S/840 DIA HE XNB GC SI	-
910505102923	BY581P 250S/840 DIA HRO GC SI	Yes
910505102925	BY581P 250S/840 DIA HE HRO GC SI	Yes
910505102927	BY581P 250S/865 DIA WB GC SI	Yes
910505102929	BY581P 250S/865 DIA HE WB GC SI	Yes
910505102931	BY581P 250S/830 DIA WB GC SI	Yes
910505102933	BY581P 250S/830 DIA HE WB GC SI	Yes
910505102935	BY581P 250S/940 DIA WB GC SI	Yes
910505102936	BY581P 250S/840 DIA HE WB GC SI XT 1m	-
910505102937	BY581P 350S/840 DIA HE WB GC SI XT 1m	-
910505104541	BY583P 250S/840 DIA HE WB GC SI 0.5m CW5	-
910505102856	BY580X 130S/840 SIA WB GC SI H4	Yes
910505102857	BY580X 170S/840 SIA WB GC SI H4	Yes
910505102860	BY580X 130S/840 SIA HE WB GC SI H4	Yes
910505102861	BY580X 170S/840 SIA HE WB GC SI H4	Yes

Light Technical (1/2)

Order Code	Full Product Name	Beam angle of light source	Correlated Color Temperature (Nom)	Color rendering index (CRI)	Luminous Efficacy (rated) (Nom)	Order Code	Full Product Name	Beam angle of light source	Correlated Color Temperature (Nom)	Color rendering index (CRI)	Luminous Efficacy (rated) (Nom)
910505102953	BY581P 700S/840 DIA WB GC SI	-	4000 K	>80	167 lm/W	910505102869	BY581X 250S/840 SIA WB GC SI ELW3 H4	-	4000 K	>80	174 lm/W
910505102954	BY581P 700S/840 DIA HE WB GC SI	-	4000 K	>80	177 lm/W	910505102870	BY581X 250S/840 SIA HE WB GC SI ELP3 H4	-	4000 K	>80	184 lm/W
910505102955	BY581P 700S/840 DIA WB GC SI BR	-	4000 K	>80	167 lm/W	910505102871	BY581X 250S/840 SIA HE WB GC SI ELW3 H4	-	4000 K	>80	184 lm/W
910505102956	BY581P 700S/840 DIA HE WB GC SI BR	-	4000 K	>80	177 lm/W	910505102864	BY580X 170S/840 SIA WB GC SI H4 BR	-	4000 K	>80	167 lm/W
910505102865	BY581X 250S/840 SIA WB GC SI H4 BR	-	4000 K	>80	174 lm/W	910505102867	BY580X 170S/840 SIA HE WB GC SI H4 BR	-	4000 K	>80	175 lm/W
910505102866	BY581X 250S/840 SIA HE WB GC SI H4 BR	-	4000 K	>80	184 lm/W	910505104565	BY581P 250S/840 DIA HEWBGCSICHEMMBW1mCW5	-	4000 K	>80	181 lm/W
910505102858	BY581X 250S/840 SIA WB GC SI H4	-	4000 K	>80	174 lm/W	910505102872	BY580P 170S/840 PSU WB GC SI	-	4000 K	>80	167 lm/W
910505102859	BY581X 350S/840 SIA WB GC SI H4	-	4000 K	>80	167 lm/W	910505102874	BY580P 170S/840 PSU HE WB GC SI	-	4000 K	>80	175 lm/W
910505102862	BY581X 250S/840 SIA HE WB GC SI H4	-	4000 K	>80	184 lm/W	910505102876	BY580P 100S/840 DIA UE WB GC SI	-	4000 K	>80	182 lm/W
910505102863	BY581X 350S/840 SIA HE WB GC SI H4	-	4000 K	>80	177 lm/W	910505102878	BY580P 130S/840 DIA WB GC SI	-	4000 K	>80	171 lm/W
910505102868	BY581X 250S/840 SIA WB GC SI ELP3 H4	-	4000 K	>80	174 lm/W	910505102879	BY580P 170S/840 DIA WB GC SI	-	4000 K	>80	167 lm/W

Order Code	Full Product Name	Beam angle of light source	Correlated Color Temperature (Nom)	Color rendering index (CRI)	Luminous Efficacy (rated) (Nom)	Order Code	Full Product Name	Beam angle of light source	Correlated Color Temperature (Nom)	Color rendering index (CRI)	Luminous Efficacy (rated) (Nom)
910505102882	BY580P 130S/840 DIA HE WB GC SI	-	4000 K	>80	178 lm/W	910505102912	BY580P 170S/840 DIA HE ASYM GC SI MBW	-	4000 K	>80	170 lm/W
910505102883	BY580P 170S/840 DIA HE WB GC SI	-	4000 K	>80	175 lm/W	910505102889	BY581P 250S/840 DIA WB GC SI BR	-	4000 K	>80	174 lm/W
910505102886	BY580P 170S/840 DIA WB PC SI	-	4000 K	>80	155 lm/W	910505102893	BY581P 250S/840 DIA HE WB GC SI BR	-	4000 K	>80	181 lm/W
910505102890	BY580P 170S/840 DIA HE WB PC SI	-	4000 K	>80	164 lm/W	910505102907	BY581P 250S/840 DIA ASYM GC SI BR	-	4000 K	>80	165 lm/W
910505102894	BY580P 170S/840 DIA WB GC SI ELP3	-	4000 K	>80	167 lm/W	910505102909	BY581P 250S/840 DIA HE ASYM GC SI BR	-	4000 K	>80	176 lm/W
910505102896	BY580P 170S/840 DIA HE WB GC SI ELP3	-	4000 K	>80	175 lm/W	910505102911	BY581P 250S/840 DIA ASYM GC SI MBW	-	4000 K	>80	165 lm/W
910505102898	BY580P 130S/840 DIA MB GC SI	-	4000 K	>80	169 lm/W	910505102913	BY581P 250S/840 DIA HE ASYM GC SI MBW	-	4000 K	>80	176 lm/W
910505102899	BY580P 170S/840 DIA MB GC SI	-	4000 K	>80	164 lm/W	910505102938	BY581P 350S/840 DIA HE WB GC SI BR XT 1m	-	4000 K	>80	177 lm/W
910505102903	BY580P 130S/840 DIA HE MB GC SI	-	4000 K	>80	178 lm/W	910505104551	BY581P 250S/840 DIA HE WB GC SI MSP BR	-	4000 K	>80	181 lm/W
910505102904	BY580P 170S/840 DIA HE MB GC SI	-	4000 K	>80	174 lm/W	910505104559	BY581X 250S/840 SIA WB GC SI IA9	-	4000 K	>80	174 lm/W
910505102914	BY580P 170S/840 DIA NB GC SI	10 or 24 degree(s)	4000 K	>80	164 lm/W	910505104561	BY581X 250S/840 SIA HE WB GC SI ELP3 IA9	-	4000 K	>80	181 lm/W
910505102916	BY580P 170S/840 DIA HE NB GC SI	10 or 24 degree(s)	4000 K	>80	174 lm/W	910505104563	BY581P 250S/840 DIA HE WBGCSCICHEMBR1mCW5	-	4000 K	>80	174 lm/W
910505102918	BY580P 170S/840 DIA XNB GC SI	-	4000 K	>80	164 lm/W	910505102888	BY580P 170S/840 DIA WB GC SI BR	-	4000 K	>80	167 lm/W
910505102920	BY580P 170S/840 DIA HE XNB GC SI	-	4000 K	>80	174 lm/W	910505102892	BY580P 170S/840 DIA HE WB GC SI BR	-	4000 K	>80	175 lm/W
910505102922	BY580P 170S/840 DIA HRO GC SI	-	4000 K	>80	164 lm/W	910505102908	BY580P 170S/840 DIA HE ASYM GC SI BR	-	4000 K	>80	170 lm/W
910505102924	BY580P 170S/840 DIA HE HRO GC SI	-	4000 K	>80	174 lm/W	910505104550	BY580P 170S/840 DIA HE WB GC SI MSP BR	-	4000 K	>80	175 lm/W
910505102926	BY580P 170S/865 DIA WB GC SI	-	6500 K	>80	164 lm/W	910505104562	BY580P 170S/840 DIA HE WBGCSCICHEMBR1mCW5	-	4000 K	>80	167 lm/W
910505102928	BY580P 170S/865 DIA HE WB GC SI	-	6500 K	>80	172 lm/W	910505104564	BY580P 170S/840 DIA HEWBGCSCICHEMBW1mCW5	-	4000 K	>80	175 lm/W
910505102930	BY580P 170S/830 DIA WB GC SI	-	3000 K	>80	155 lm/W	910505102873	BY581P 250S/840 PSU WB GC SI	-	4000 K	>80	174 lm/W
910505102932	BY580P 170S/830 DIA HE WB GC SI	-	3000 K	>80	159 lm/W	910505102875	BY581P 250S/840 PSU HE WB GC SI	-	4000 K	>80	184 lm/W
910505102934	BY580P 170S/940 DIA WB GC SI	-	4000 K	>90	157 lm/W	910505102877	BY581P 200S/840 DIA UE WB GC SI	-	4000 K	>80	189 lm/W
910505104558	BY580X 170S/840 SIA WB GC SI IA9	-	4000 K	>80	167 lm/W	910505102880	BY581P 250S/840 DIA WB GC SI	-	4000 K	>80	174 lm/W
910505104560	BY580X 170S/840 SIA HE WB GC SI ELP3 IA9	-	4000 K	>80	175 lm/W	910505102881	BY581P 350S/840 DIA WB GC SI	-	4000 K	>80	167 lm/W
910505102910	BY580P 170S/840 DIA ASYM GC SI MBW	-	4000 K	>80	157 lm/W	910505102884	BY581P 250S/840 DIA HE WB GC SI	-	4000 K	>80	181 lm/W

Order Code	Full Product Name	Beam angle of light source	Correlated Color Temperature (Nom)	Color rendering index (CRI)	Luminous Efficacy (rated) (Nom)	Order Code	Full Product Name	Beam angle of light source	Correlated Color Temperature (Nom)	Color rendering index (CRI)	Luminous Efficacy (rated) (Nom)
910505102885	BY581P 350S/840 DIA HE WB GC SI	-	4000 K	>80	177 lm/W	910505102925	BY581P 250S/840 DIA HE HRO GC SI	-	4000 K	>80	181 lm/W
910505102887	BY581P 250S/840 DIA WB PC SI	-	4000 K	>80	162 lm/W	910505102927	BY581P 250S/865 DIA WB GC SI	-	6500 K	>80	171 lm/W
910505102891	BY581P 250S/840 DIA HE WB PC SI	-	4000 K	>80	171 lm/W	910505102929	BY581P 250S/865 DIA HE WB GC SI	-	6500 K	>80	179 lm/W
910505102895	BY581P 250S/840 DIA WB GC SI ELD3	-	4000 K	>80	174 lm/W	910505102931	BY581P 250S/830 DIA WB GC SI	-	3000 K	>80	162 lm/W
910505102897	BY581P 250S/840 DIA HE WB GC SI ELD3	-	4000 K	>80	181 lm/W	910505102933	BY581P 250S/830 DIA HE WB GC SI	-	3000 K	>80	171 lm/W
910505102901	BY581P 250S/840 DIA MB GC SI	-	4000 K	>80	171 lm/W	910505102935	BY581P 250S/940 DIA WB GC SI	-	4000 K	>90	165 lm/W
910505102902	BY581P 350S/840 DIA MB GC SI	-	4000 K	>80	167 lm/W	910505102936	BY581P 250S/840 DIA HE WB GC SI XT 1m	-	4000 K	>80	181 lm/W
910505102905	BY581P 250S/840 DIA HE MB GC SI	-	4000 K	>80	181 lm/W	910505102937	BY581P 350S/840 DIA HE WB GC SI XT 1m	-	4000 K	>80	177 lm/W
910505102906	BY581P 350S/840 DIA HE MB GC SI	-	4000 K	>80	175 lm/W	910505104541	BY583P 250S/840 DIA HE WB GC SI 0.5m CW5	-	4000 K	>80	174 lm/W
910505102915	BY581P 250S/840 DIA NB GC SI	10 or 24 degree(s)	4000 K	>80	171 lm/W	910505102856	BY580X 130S/840 SIA WB GC SI H4	-	4000 K	>80	171 lm/W
910505102917	BY581P 250S/840 DIA HE NB GC SI	10 or 24 degree(s)	4000 K	>80	181 lm/W	910505102857	BY580X 170S/840 SIA WB GC SI H4	-	4000 K	>80	167 lm/W
910505102919	BY581P 250S/840 DIA XNB GC SI	-	4000 K	>80	171 lm/W	910505102860	BY580X 130S/840 SIA HE WB GC SI H4	-	4000 K	>80	178 lm/W
910505102921	BY581P 250S/840 DIA HE XNB GC SI	-	4000 K	>80	181 lm/W	910505102861	BY580X 170S/840 SIA HE WB GC SI H4	-	4000 K	>80	175 lm/W
910505102923	BY581P 250S/840 DIA HRO GC SI	-	4000 K	>80	171 lm/W						

Light Technical (2/2)

Order Code	Full Product Name	Luminous Flux	Optic type	Order Code	Full Product Name	Luminous Flux	Optic type
910505102953	BY581P 700S/840 DIA WB GC SI	70,000 lm	Wide beam	910505102871	BY581X 250S/840 SIA HE WB GC SI ELW3 H4	25,000 lm	Wide beam
910505102954	BY581P 700S/840 DIA HE WB GC SI	70,000 lm	Wide beam	910505102864	BY580X 170S/840 SIA WB GC SI H4 BR	17,000 lm	Wide beam
910505102955	BY581P 700S/840 DIA WB GC SI BR	70,000 lm	Wide beam	910505102867	BY580X 170S/840 SIA HE WB GC SI H4 BR	17,000 lm	Wide beam
910505102956	BY581P 700S/840 DIA HE WB GC SI BR	70,000 lm	Wide beam	910505104565	BY581P 250S/840 DIA HEWBGCSCICHEMBW1mCW5	25,000 lm	Wide beam
910505102865	BY581X 250S/840 SIA WB GC SI H4 BR	25,000 lm	Wide beam	910505102872	BY580P 170S/840 PSU WB GC SI	17,000 lm	Wide beam
910505102866	BY581X 250S/840 SIA HE WB GC SI H4 BR	25,000 lm	Wide beam	910505102874	BY580P 170S/840 PSU HE WB GC SI	17,000 lm	Wide beam
910505102858	BY581X 250S/840 SIA WB GC SI H4	25,000 lm	Wide beam	910505102876	BY580P 100S/840 DIA UE WB GC SI	10,000 lm	Wide beam
910505102859	BY581X 350S/840 SIA WB GC SI H4	35,000 lm	Wide beam	910505102878	BY580P 130S/840 DIA WB GC SI	13,000 lm	Wide beam
910505102862	BY581X 250S/840 SIA HE WB GC SI H4	25,000 lm	Wide beam	910505102879	BY580P 170S/840 DIA WB GC SI	17,000 lm	Wide beam
910505102863	BY581X 350S/840 SIA HE WB GC SI H4	35,000 lm	Wide beam	910505102882	BY580P 130S/840 DIA HE WB GC SI	13,000 lm	Wide beam
910505102868	BY581X 250S/840 SIA WB GC SI ELP3 H4	25,000 lm	Wide beam	910505102883	BY580P 170S/840 DIA HE WB GC SI	17,000 lm	Wide beam
910505102869	BY581X 250S/840 SIA WB GC SI ELW3 H4	25,000 lm	Wide beam	910505102886	BY580P 170S/840 DIA WB PC SI	17,000 lm	Wide beam
910505102870	BY581X 250S/840 SIA HE WB GC SI ELP3 H4	25,000 lm	Wide beam	910505102890	BY580P 170S/840 DIA HE WB PC SI	17,000 lm	Wide beam

Order Code	Full Product Name	Luminous	
		Flux	Optic type
910505102894	BY580P 170S/840 DIA WB GC SI ELP3	17,000 lm	Wide beam
910505102896	BY580P 170S/840 DIA HE WB GC SI ELP3	17,000 lm	Wide beam
910505102898	BY580P 130S/840 DIA MB GC SI	13,000 lm	Medium beam
910505102899	BY580P 170S/840 DIA MB GC SI	17,000 lm	Medium beam
910505102903	BY580P 130S/840 DIA HE MB GC SI	13,000 lm	Medium beam
910505102904	BY580P 170S/840 DIA HE MB GC SI	17,000 lm	Medium beam
910505102914	BY580P 170S/840 DIA NB GC SI	17,000 lm	Narrow beam
910505102916	BY580P 170S/840 DIA HE NB GC SI	17,000 lm	Narrow beam
910505102918	BY580P 170S/840 DIA XNB GC SI	17,000 lm	Narrow beam
910505102920	BY580P 170S/840 DIA HE XNB GC SI	17,000 lm	Narrow beam
910505102922	BY580P 170S/840 DIA HRO GC SI	17,000 lm	High-rack optic
910505102924	BY580P 170S/840 DIA HE HRO GC SI	17,000 lm	High-rack optic
910505102926	BY580P 170S/865 DIA WB GC SI	17,000 lm	Wide beam
910505102928	BY580P 170S/865 DIA HE WB GC SI	17,000 lm	Wide beam
910505102930	BY580P 170S/830 DIA WB GC SI	17,000 lm	Wide beam
910505102932	BY580P 170S/830 DIA HE WB GC SI	17,000 lm	Wide beam
910505102934	BY580P 170S/940 DIA WB GC SI	17,000 lm	Wide beam
910505104558	BY580X 170S/840 SIA WB GC SI IA9	17,000 lm	Wide beam
910505104560	BY580X 170S/840 SIA HE WB GC SI ELP3 IA9	17,000 lm	Wide beam
910505102910	BY580P 170S/840 DIA ASYM GC SI MBW	17,000 lm	Assymetric Beam angle
910505102912	BY580P 170S/840 DIA HE ASYM GC SI MBW	17,000 lm	Assymetric Beam angle
910505102889	BY581P 250S/840 DIA WB GC SI BR	25,000 lm	Wide beam
910505102893	BY581P 250S/840 DIA HE WB GC SI BR	25,000 lm	Wide beam
910505102907	BY581P 250S/840 DIA ASYM GC SI BR	25,000 lm	Assymetric Beam angle
910505102909	BY581P 250S/840 DIA HE ASYM GC SI BR	25,000 lm	Assymetric Beam angle
910505102911	BY581P 250S/840 DIA ASYM GC SI MBW	25,000 lm	Assymetric Beam angle
910505102913	BY581P 250S/840 DIA HE ASYM GC SI MBW	25,000 lm	Assymetric Beam angle
910505102938	BY581P 350S/840 DIA HE WB GC SI BR XT 1m	35,000 lm	Wide beam
910505104551	BY581P 250S/840 DIA HE WB GC SI MSP BR	25,000 lm	Wide beam
910505104559	BY581X 250S/840 SIA WB GC SI IA9	25,000 lm	Wide beam
910505104561	BY581X 250S/840 SIA HE WB GC SI ELP3 IA9	25,000 lm	Wide beam
910505104563	BY581P 250S/840 DIA HE WBGC SICHEMBR1mCW5	25,000 lm	Wide beam
910505102888	BY580P 170S/840 DIA WB GC SI BR	17,000 lm	Wide beam

Order Code	Full Product Name	Luminous	
		Flux	Optic type
910505102892	BY580P 170S/840 DIA HE WB GC SI BR	17,000 lm	Wide beam
910505102908	BY580P 170S/840 DIA HE ASYM GC SI BR	17,000 lm	Assymetric Beam angle
910505104550	BY580P 170S/840 DIA HE WB GC SI MSP BR	17,000 lm	Wide beam
910505104562	BY580P 170S/840 DIA HE WBGC SICHEMBR1mCW5	17,000 lm	Wide beam
910505104564	BY580P 170S/840 DIA HEWBGC SICHEMMBW1mCW5	17,000 lm	Wide beam
910505102873	BY581P 250S/840 PSU WB GC SI	25,000 lm	Wide beam
910505102875	BY581P 250S/840 PSU HE WB GC SI	25,000 lm	Wide beam
910505102877	BY581P 200S/840 DIA UE WB GC SI	20,000 lm	Wide beam
910505102880	BY581P 250S/840 DIA WB GC SI	25,000 lm	Wide beam
910505102881	BY581P 350S/840 DIA WB GC SI	35,000 lm	Wide beam
910505102884	BY581P 250S/840 DIA HE WB GC SI	25,000 lm	Wide beam
910505102885	BY581P 350S/840 DIA HE WB GC SI	35,000 lm	Wide beam
910505102887	BY581P 250S/840 DIA WB PC SI	25,000 lm	Wide beam
910505102891	BY581P 250S/840 DIA HE WB PC SI	25,000 lm	Wide beam
910505102895	BY581P 250S/840 DIA WB GC SI ELD3	25,000 lm	Wide beam
910505102897	BY581P 250S/840 DIA HE WB GC SI ELD3	25,000 lm	Wide beam
910505102901	BY581P 250S/840 DIA MB GC SI	25,000 lm	Medium beam
910505102902	BY581P 350S/840 DIA MB GC SI	35,000 lm	Medium beam
910505102905	BY581P 250S/840 DIA HE MB GC SI	25,000 lm	Medium beam
910505102906	BY581P 350S/840 DIA HE MB GC SI	35,000 lm	Medium beam
910505102915	BY581P 250S/840 DIA NB GC SI	25,000 lm	Narrow beam
910505102917	BY581P 250S/840 DIA HE NB GC SI	25,000 lm	Narrow beam
910505102919	BY581P 250S/840 DIA XNB GC SI	25,000 lm	Narrow beam
910505102921	BY581P 250S/840 DIA HE XNB GC SI	25,000 lm	Narrow beam
910505102923	BY581P 250S/840 DIA HRO GC SI	25,000 lm	High-rack optic
910505102925	BY581P 250S/840 DIA HE HRO GC SI	25,000 lm	High-rack optic
910505102927	BY581P 250S/865 DIA WB GC SI	25,000 lm	Wide beam
910505102929	BY581P 250S/865 DIA HE WB GC SI	25,000 lm	Wide beam
910505102931	BY581P 250S/830 DIA WB GC SI	25,000 lm	Wide beam
910505102933	BY581P 250S/830 DIA HE WB GC SI	25,000 lm	Wide beam
910505102935	BY581P 250S/940 DIA WB GC SI	25,000 lm	Wide beam
910505102936	BY581P 250S/840 DIA HE WB GC SI XT 1m	25,000 lm	Wide beam
910505102937	BY581P 350S/840 DIA HE WB GC SI XT 1m	35,000 lm	Wide beam
910505104541	BY583P 250S/840 DIA HE WB GC SI 0.5m CW5	25,000 lm	Wide beam
910505102856	BY580X 130S/840 SIA WB GC SI H4	13,000 lm	Wide beam
910505102857	BY580X 170S/840 SIA WB GC SI H4	17,000 lm	Wide beam
910505102860	BY580X 130S/840 SIA HE WB GC SI H4	13,000 lm	Wide beam
910505102861	BY580X 170S/840 SIA HE WB GC SI H4	17,000 lm	Wide beam

Operating and Electrical

Order Code	Full Product Name	Power Consumption	Suitable for random switching
910505102953	BY581P 700S/840 DIA WB GC SI	420 W	No
910505102954	BY581P 700S/840 DIA HE WB GC SI	397 W	No
910505102955	BY581P 700S/840 DIA WB GC SI BR	420 W	No
910505102956	BY581P 700S/840 DIA HE WB GC SI BR	397 W	No
910505102865	BY581X 250S/840 SIA WB GC SI H4 BR	144 W	Yes (relates to presence/movement detection and daylight harvesting)
910505102866	BY581X 250S/840 SIA HE WB GC SI H4 BR	136 W	Yes (relates to presence/movement detection and daylight harvesting)
910505102858	BY581X 250S/840 SIA WB GC SI H4	144 W	Yes (relates to presence/movement detection and daylight harvesting)
910505102859	BY581X 350S/840 SIA WB GC SI H4	210 W	Yes (relates to presence/movement detection and daylight harvesting)
910505102862	BY581X 250S/840 SIA HE WB GC SI H4	136 W	Yes (relates to presence/movement detection and daylight harvesting)
910505102863	BY581X 350S/840 SIA HE WB GC SI H4	198 W	Yes (relates to presence/movement detection and daylight harvesting)
910505102868	BY581X 250S/840 SIA WB GC SI ELP3 H4	144 W	Yes (relates to presence/movement detection and daylight harvesting)
910505102869	BY581X 250S/840 SIA WB GC SI ELW3 H4	144 W	Yes (relates to presence/movement)

Order Code	Full Product Name	Power Consumption	Suitable for random switching
910505102870	BY581X 250S/840 SIA HE WB GC SI ELP3 H4	136 W	Yes (relates to presence/movement detection and daylight harvesting)
910505102871	BY581X 250S/840 SIA HE WB GC SI ELW3 H4	136 W	Yes (relates to presence/movement detection and daylight harvesting)
910505102864	BY580X 170S/840 SIA WB GC SI H4 BR	102 W	Yes (relates to presence/movement detection and daylight harvesting)
910505102867	BY580X 170S/840 SIA HE WB GC SI H4 BR	97 W	Yes (relates to presence/movement detection and daylight harvesting)
910505104565	BY581P 250S/840 DIA HEWBGCSICHEMMBW1mCW5	138 W	No
910505102872	BY580P 170S/840 PSU WB GC SI	102 W	No
910505102874	BY580P 170S/840 PSU HE WB GC SI	97 W	No
910505102876	BY580P 100S/840 DIA UE WB GC SI	55 W	No
910505102878	BY580P 130S/840 DIA WB GC SI	76 W	No
910505102879	BY580P 170S/840 DIA WB GC SI	102 W	No
910505102882	BY580P 130S/840 DIA HE WB GC SI	73 W	No
910505102883	BY580P 170S/840 DIA HE WB GC SI	97 W	No
910505102886	BY580P 170S/840 DIA WB PC SI	110 W	No
910505102890	BY580P 170S/840 DIA HE WB PC SI	104 W	No
910505102894	BY580P 170S/840 DIA WB GC SI ELP3	102 W	No
910505102896	BY580P 170S/840 DIA HE WB GC SI ELP3	97 W	No
910505102898	BY580P 130S/840 DIA MB GC SI	77 W	No
910505102899	BY580P 170S/840 DIA MB GC SI	104 W	No
910505102903	BY580P 130S/840 DIA HE MB GC SI	73 W	No
910505102904	BY580P 170S/840 DIA HE MB GC SI	98 W	No
910505102914	BY580P 170S/840 DIA NB GC SI	104 W	No
910505102916	BY580P 170S/840 DIA HE NB GC SI	98 W	No
910505102918	BY580P 170S/840 DIA XNB GC SI	104 W	No
910505102920	BY580P 170S/840 DIA HE XNB GC SI	98 W	No
910505102922	BY580P 170S/840 DIA HRO GC SI	104 W	No

Order Code	Full Product Name	Power Consumption	Suitable for random switching
910505102924	BY580P 170S/840 DIA HE HRO GC SI	98 W	No
910505102926	BY580P 170S/865 DIA WB GC SI	104 W	No
910505102928	BY580P 170S/865 DIA HE WB GC SI	99 W	No
910505102930	BY580P 170S/830 DIA WB GC SI	110 W	No
910505102932	BY580P 170S/830 DIA HE WB GC SI	104 W	No
910505102934	BY580P 170S/940 DIA WB GC SI	108 W	No
910505104558	BY580X 170S/840 SIA WB GC SI IA9	102 W	Yes (relates to presence/movement detection and daylight harvesting)
910505104560	BY580X 170S/840 SIA HE WB GC SI ELP3 IA9	97 W	Yes (relates to presence/movement detection and daylight harvesting)
910505102910	BY580P 170S/840 DIA ASYM GC SI MBW	108 W	No
910505102912	BY580P 170S/840 DIA HE ASYM GC SI MBW	100 W	No
910505102889	BY581P 250S/840 DIA WB GC SI BR	144 W	No
910505102893	BY581P 250S/840 DIA HE WB GC SI BR	138 W	No
910505102907	BY581P 250S/840 DIA ASYM GC SI BR	152 W	No
910505102909	BY581P 250S/840 DIA HE ASYM GC SI BR	142 W	No
910505102911	BY581P 250S/840 DIA ASYM GC SI MBW	152 W	No
910505102913	BY581P 250S/840 DIA HE ASYM GC SI MBW	142 W	No
910505102938	BY581P 350S/840 DIA HE WB GC SI BR XT 1m	198 W	No
910505104551	BY581P 250S/840 DIA HE WB GC SI MSP BR	138 W	No
910505104559	BY581X 250S/840 SIA WB GC SI IA9	144 W	Yes (relates to presence/movement detection and daylight harvesting)
910505104561	BY581X 250S/840 SIA HE WB GC SI ELP3 IA9	138 W	Yes (relates to presence/movement detection and daylight harvesting)
910505104563	BY581P 250S/840 DIA HE WBGCSICHEMBR1mCW5	144 W	No
910505102888	BY580P 170S/840 DIA WB GC SI BR	102 W	No

Order Code	Full Product Name	Power Consumption	Suitable for random switching
910505102892	BY580P 170S/840 DIA HE WB GC SI BR	97 W	No
910505102908	BY580P 170S/840 DIA HE ASYM GC SI BR	100 W	No
910505104550	BY580P 170S/840 DIA HE WB GC SI MSP BR	97 W	No
910505104562	BY580P 170S/840 DIA HE WBGCSICHEMBR1mCW5	102 W	No
910505104564	BY580P 170S/840 DIA HEWBGCSICHEMMBW1mCW5	97 W	No
910505102873	BY581P 250S/840 PSU WB GC SI	144 W	No
910505102875	BY581P 250S/840 PSU HE WB GC SI	136 W	No
910505102877	BY581P 200S/840 DIA UE WB GC SI	106 W	No
910505102880	BY581P 250S/840 DIA WB GC SI	144 W	No
910505102881	BY581P 350S/840 DIA WB GC SI	210 W	No
910505102884	BY581P 250S/840 DIA HE WB GC SI	138 W	No
910505102885	BY581P 350S/840 DIA HE WB GC SI	198 W	No
910505102887	BY581P 250S/840 DIA WB PC SI	154 W	No
910505102891	BY581P 250S/840 DIA HE WB PC SI	146 W	No
910505102895	BY581P 250S/840 DIA WB GC SI ELD3	144 W	No
910505102897	BY581P 250S/840 DIA HE WB GC SI ELD3	138 W	No
910505102901	BY581P 250S/840 DIA MB GC SI	146 W	No
910505102902	BY581P 350S/840 DIA MB GC SI	210 W	No
910505102905	BY581P 250S/840 DIA HE MB GC SI	138 W	No
910505102906	BY581P 350S/840 DIA HE MB GC SI	200 W	No
910505102915	BY581P 250S/840 DIA NB GC SI	146 W	No
910505102917	BY581P 250S/840 DIA HE NB GC SI	138 W	No
910505102919	BY581P 250S/840 DIA XNB GC SI	146 W	No
910505102921	BY581P 250S/840 DIA HE XNB GC SI	138 W	No
910505102923	BY581P 250S/840 DIA HRO GC SI	146 W	No
910505102925	BY581P 250S/840 DIA HE HRO GC SI	138 W	No
910505102927	BY581P 250S/865 DIA WB GC SI	146 W	No
910505102929	BY581P 250S/865 DIA HE WB GC SI	140 W	No
910505102931	BY581P 250S/830 DIA WB GC SI	154 W	No
910505102933	BY581P 250S/830 DIA HE WB GC SI	146 W	No
910505102935	BY581P 250S/940 DIA WB GC SI	152 W	No
910505102936	BY581P 250S/840 DIA HE WB GC SI XT 1m	138 W	No
910505102937	BY581P 350S/840 DIA HE WB GC SI XT 1m	198 W	No
910505104541	BY583P 250S/840 DIA HE WB GC SI 0.5m CW5	144 W	No
910505102856	BY580X 130S/840 SIA WB GC SI H4	76 W	Yes (relates to presence/movement detection and daylight harvesting)

Order Code	Full Product Name	Power Consumption	Suitable for random switching
910505102857	BY580X 170S/840 SIA WB GC SI H4	102 W	Yes (relates to presence/movement detection and daylight harvesting)
910505102860	BY580X 130S/840 SIA HE WB GC SI H4	73 W	Yes (relates to presence/movement detection and daylight harvesting)

Order Code	Full Product Name	Power Consumption	Suitable for random switching
910505102861	BY580X 170S/840 SIA HE WB GC SI H4	97 W	Yes (relates to presence/movement detection and daylight harvesting)

Controls and Dimming

Order Code	Full Product Name	Dimmable	Embedded control	Maximum dim level
910505102953	BY581P 700S/840 DIA WB GC SI	Yes	-	10%
910505102954	BY581P 700S/840 DIA HE WB GC SI	Yes	-	10%
910505102955	BY581P 700S/840 DIA WB GC SI BR	Yes	-	10%
910505102956	BY581P 700S/840 DIA HE WB GC SI BR	Yes	-	10%
910505102865	BY581X 250S/840 SIA WB GC SI H4 BR	Yes	Sensor SNH (R) 210	-
910505102866	BY581X 250S/840 SIA HE WB GC SI H4 BR	Yes	Sensor SNH (R) 210	-
910505102858	BY581X 250S/840 SIA WB GC SI H4	Yes	Sensor SNH (R) 210	-
910505102859	BY581X 350S/840 SIA WB GC SI H4	Yes	Sensor SNH (R) 210	-
910505102862	BY581X 250S/840 SIA HE WB GC SI H4	Yes	Sensor SNH (R) 210	-
910505102863	BY581X 350S/840 SIA HE WB GC SI H4	Yes	Sensor SNH (R) 210	-
910505102868	BY581X 250S/840 SIA WB GC SI ELP3 H4	Yes	Sensor SNH (R) 210	-
910505102869	BY581X 250S/840 SIA WB GC SI ELW3 H4	Yes	Sensor SNH (R) 210	-
910505102870	BY581X 250S/840 SIA HE WB GC SI ELP3 H4	Yes	Sensor SNH (R) 210	-
910505102871	BY581X 250S/840 SIA HE WB GC SI ELW3 H4	Yes	Sensor SNH (R) 210	-
910505102864	BY580X 170S/840 SIA WB GC SI H4 BR	Yes	Sensor SNH (R) 210	-
910505102867	BY580X 170S/840 SIA HE WB GC SI H4 BR	Yes	Sensor SNH (R) 210	-
910505104565	BY581P 250S/840 DIA HEWBGC SICHEMMBW1mCW5	Yes	-	10%
910505102872	BY580P 170S/840 PSU WB GC SI	No	-	-
910505102874	BY580P 170S/840 PSU HE WB GC SI	No	-	-

Order Code	Full Product Name	Dimmable	Embedded control	Maximum dim level
910505102876	BY580P 100S/840 DIA UE WB GC SI	Yes	-	10%
910505102878	BY580P 130S/840 DIA WB GC SI	Yes	-	10%
910505102879	BY580P 170S/840 DIA WB GC SI	Yes	-	10%
910505102882	BY580P 130S/840 DIA HE WB GC SI	Yes	-	10%
910505102883	BY580P 170S/840 DIA HE WB GC SI	Yes	-	10%
910505102886	BY580P 170S/840 DIA WB PC SI	Yes	-	10%
910505102890	BY580P 170S/840 DIA HE WB PC SI	Yes	-	10%
910505102894	BY580P 170S/840 DIA WB GC SI ELP3	Yes	-	10%
910505102896	BY580P 170S/840 DIA HE WB GC SI ELP3	Yes	-	10%
910505102898	BY580P 130S/840 DIA MB GC SI	Yes	-	10%
910505102899	BY580P 170S/840 DIA MB GC SI	Yes	-	10%
910505102903	BY580P 130S/840 DIA HE MB GC SI	Yes	-	10%
910505102904	BY580P 170S/840 DIA HE MB GC SI	Yes	-	10%
910505102914	BY580P 170S/840 DIA NB GC SI	Yes	-	10%
910505102916	BY580P 170S/840 DIA HE NB GC SI	Yes	-	10%
910505102918	BY580P 170S/840 DIA XNB GC SI	Yes	-	10%
910505102920	BY580P 170S/840 DIA HE XNB GC SI	Yes	-	10%
910505102922	BY580P 170S/840 DIA HRO GC SI	Yes	-	10%
910505102924	BY580P 170S/840 DIA HE HRO GC SI	Yes	-	10%
910505102926	BY580P 170S/865 DIA WB GC SI	Yes	-	10%
910505102928	BY580P 170S/865 DIA HE WB GC SI	Yes	-	10%
910505102930	BY580P 170S/830 DIA WB GC SI	Yes	-	10%
910505102932	BY580P 170S/830 DIA HE WB GC SI	Yes	-	10%

Order Code	Full Product Name	Dimmable	Embedded control	Maximum dim level
910505102934	BY580P 170S/940 DIA WB GC SI	Yes	-	10%
910505104558	BY580X 170S/840 SIA WB GC SI IA9	Yes	Sensor SNH (R) 210	-
910505104560	BY580X 170S/840 SIA HE WB GC SI ELP3 IA9	Yes	Sensor SNH (R) 210	-
910505102910	BY580P 170S/840 DIA ASYM GC SI MBW	Yes	-	10%
910505102912	BY580P 170S/840 DIA HE ASYM GC SI MBW	Yes	-	10%
910505102889	BY581P 250S/840 DIA WB GC SI BR	Yes	-	10%
910505102893	BY581P 250S/840 DIA HE WB GC SI BR	Yes	-	10%
910505102907	BY581P 250S/840 DIA ASYM GC SI BR	Yes	-	10%
910505102909	BY581P 250S/840 DIA HE ASYM GC SI BR	Yes	-	10%
910505102911	BY581P 250S/840 DIA ASYM GC SI MBW	Yes	-	10%
910505102913	BY581P 250S/840 DIA HE ASYM GC SI MBW	Yes	-	10%
910505102938	BY581P 350S/840 DIA HE WB GC SI BR XT 1m	Yes	-	10%
910505104551	BY581P 250S/840 DIA HE WB GC SI MSP BR	Yes	-	10%
910505104559	BY581X 250S/840 SIA WB GC SI IA9	Yes	Sensor SNH (R) 210	-
910505104561	BY581X 250S/840 SIA HE WB GC SI ELP3 IA9	Yes	Sensor SNH (R) 210	-
910505104563	BY581P 250S/840 DIA HE WBGCSICHEMBR1mCW5	Yes	-	10%
910505102888	BY580P 170S/840 DIA WB GC SI BR	Yes	-	10%
910505102892	BY580P 170S/840 DIA HE WB GC SI BR	Yes	-	10%
910505102908	BY580P 170S/840 DIA HE ASYM GC SI BR	Yes	-	10%
910505104550	BY580P 170S/840 DIA HE WB GC SI MSP BR	Yes	-	10%
910505104562	BY580P 170S/840 DIA HE WBGCSICHEMBR1mCW5	Yes	-	10%
910505104564	BY580P 170S/840 DIA HEWBGCSICHEMMBW1mCW5	Yes	-	10%
910505102873	BY581P 250S/840 PSU WB GC SI	No	-	-
910505102875	BY581P 250S/840 PSU HE WB GC SI	No	-	-
910505102877	BY581P 200S/840 DIA UE WB GC SI	Yes	-	10%
910505102880	BY581P 250S/840 DIA WB GC SI	Yes	-	10%

Order Code	Full Product Name	Dimmable	Embedded control	Maximum dim level
910505102881	BY581P 350S/840 DIA WB GC SI	Yes	-	10%
910505102884	BY581P 250S/840 DIA HE WB GC SI	Yes	-	10%
910505102885	BY581P 350S/840 DIA HE WB GC SI	Yes	-	10%
910505102887	BY581P 250S/840 DIA WB PC SI	Yes	-	10%
910505102891	BY581P 250S/840 DIA HE WB PC SI	Yes	-	10%
910505102895	BY581P 250S/840 DIA WB GC SI ELD3	Yes	-	10%
910505102897	BY581P 250S/840 DIA HE WB GC SI ELD3	Yes	-	10%
910505102901	BY581P 250S/840 DIA MB GC SI	Yes	-	10%
910505102902	BY581P 350S/840 DIA MB GC SI	Yes	-	10%
910505102905	BY581P 250S/840 DIA HE MB GC SI	Yes	-	10%
910505102906	BY581P 350S/840 DIA HE MB GC SI	Yes	-	10%
910505102915	BY581P 250S/840 DIA NB GC SI	Yes	-	10%
910505102917	BY581P 250S/840 DIA HE NB GC SI	Yes	-	10%
910505102919	BY581P 250S/840 DIA XNB GC SI	Yes	-	10%
910505102921	BY581P 250S/840 DIA HE XNB GC SI	Yes	-	10%
910505102923	BY581P 250S/840 DIA HRO GC SI	Yes	-	10%
910505102925	BY581P 250S/840 DIA HE HRO GC SI	Yes	-	10%
910505102927	BY581P 250S/865 DIA WB GC SI	Yes	-	10%
910505102929	BY581P 250S/865 DIA HE WB GC SI	Yes	-	10%
910505102931	BY581P 250S/830 DIA WB GC SI	Yes	-	10%
910505102933	BY581P 250S/830 DIA HE WB GC SI	Yes	-	10%
910505102935	BY581P 250S/940 DIA WB GC SI	Yes	-	10%
910505102936	BY581P 250S/840 DIA HE WB GC SI XT 1m	Yes	-	10%
910505102937	BY581P 350S/840 DIA HE WB GC SI XT 1m	Yes	-	10%
910505104541	BY583P 250S/840 DIA HE WB GC SI 0.5m CW5	DALI	-	10%
910505102856	BY580X 130S/840 SIA WB GC SI H4	Yes	Sensor SNH (R) 210	-
910505102857	BY580X 170S/840 SIA WB GC SI H4	Yes	Sensor SNH (R) 210	-
910505102860	BY580X 130S/840 SIA HE WB GC SI H4	Yes	Sensor SNH (R) 210	-
910505102861	BY580X 170S/840 SIA HE WB GC SI H4	Yes	Sensor SNH (R) 210	-

Mechanical and Housing

Order Code	Full Product Name	Mech. impact protection code
910505102953	BY581P 700S/840 DIA WB GC SI	IK07
910505102954	BY581P 700S/840 DIA HE WB GC SI	IK07
910505102955	BY581P 700S/840 DIA WB GC SI BR	IK07
910505102956	BY581P 700S/840 DIA HE WB GC SI BR	IK07
910505102865	BY581X 250S/840 SIA WB GC SI H4 BR	IK03
910505102866	BY581X 250S/840 SIA HE WB GC SI H4 BR	IK03
910505102858	BY581X 250S/840 SIA WB GC SI H4	IK03
910505102859	BY581X 350S/840 SIA WB GC SI H4	IK03
910505102862	BY581X 250S/840 SIA HE WB GC SI H4	IK03
910505102863	BY581X 350S/840 SIA HE WB GC SI H4	IK03
910505102868	BY581X 250S/840 SIA WB GC SI ELP3 H4	IK03
910505102869	BY581X 250S/840 SIA WB GC SI ELW3 H4	IK03
910505102870	BY581X 250S/840 SIA HE WB GC SI ELP3 H4	IK03
910505102871	BY581X 250S/840 SIA HE WB GC SI ELW3 H4	IK03
910505102864	BY580X 170S/840 SIA WB GC SI H4 BR	IK03
910505102867	BY580X 170S/840 SIA HE WB GC SI H4 BR	IK03
910505104565	BY581P 250S/840 DIA HEWBGCSICHEMMBW1mCW5	IK07
910505102872	BY580P 170S/840 PSU WB GC SI	IK07
910505102874	BY580P 170S/840 PSU HE WB GC SI	IK07
910505102876	BY580P 100S/840 DIA UE WB GC SI	IK07
910505102878	BY580P 130S/840 DIA WB GC SI	IK07
910505102879	BY580P 170S/840 DIA WB GC SI	IK07
910505102882	BY580P 130S/840 DIA HE WB GC SI	IK07
910505102883	BY580P 170S/840 DIA HE WB GC SI	IK07
910505102886	BY580P 170S/840 DIA WB PC SI	IK07
910505102890	BY580P 170S/840 DIA HE WB PC SI	IK07
910505102894	BY580P 170S/840 DIA WB GC SI ELP3	IK07
910505102896	BY580P 170S/840 DIA HE WB GC SI ELP3	IK07
910505102898	BY580P 130S/840 DIA MB GC SI	IK07
910505102899	BY580P 170S/840 DIA MB GC SI	IK07
910505102903	BY580P 130S/840 DIA HE MB GC SI	IK07
910505102904	BY580P 170S/840 DIA HE MB GC SI	IK07
910505102914	BY580P 170S/840 DIA NB GC SI	IK07
910505102916	BY580P 170S/840 DIA HE NB GC SI	IK07
910505102918	BY580P 170S/840 DIA XNB GC SI	IK07
910505102920	BY580P 170S/840 DIA HE XNB GC SI	IK07
910505102922	BY580P 170S/840 DIA HRO GC SI	IK07
910505102924	BY580P 170S/840 DIA HE HRO GC SI	IK07
910505102926	BY580P 170S/865 DIA WB GC SI	IK07
910505102928	BY580P 170S/865 DIA HE WB GC SI	IK07
910505102930	BY580P 170S/830 DIA WB GC SI	IK07
910505102932	BY580P 170S/830 DIA HE WB GC SI	IK07
910505102934	BY580P 170S/940 DIA WB GC SI	IK07
910505104558	BY580X 170S/840 SIA WB GC SI IA9	IK03
910505104560	BY580X 170S/840 SIA HE WB GC SI ELP3 IA9	IK03
910505102910	BY580P 170S/840 DIA ASYM GC SI MBW	IK07
910505102912	BY580P 170S/840 DIA HE ASYM GC SI MBW	IK07
910505102889	BY581P 250S/840 DIA WB GC SI BR	IK07
910505102893	BY581P 250S/840 DIA HE WB GC SI BR	IK07

Order Code	Full Product Name	Mech. impact protection code
910505102907	BY581P 250S/840 DIA ASYM GC SI BR	IK07
910505102909	BY581P 250S/840 DIA HE ASYM GC SI BR	IK07
910505102911	BY581P 250S/840 DIA ASYM GC SI MBW	IK07
910505102913	BY581P 250S/840 DIA HE ASYM GC SI MBW	IK07
910505102938	BY581P 350S/840 DIA HE WB GC SI BR XT 1m	IK07
910505104551	BY581P 250S/840 DIA HE WB GC SI MSP BR	IK07
910505104559	BY581X 250S/840 SIA WB GC SI IA9	IK03
910505104561	BY581X 250S/840 SIA HE WB GC SI ELP3 IA9	IK03
910505104563	BY581P 250S/840 DIA HE WBGCSICHEMBR1mCW5	IK07
910505102888	BY580P 170S/840 DIA WB GC SI BR	IK07
910505102892	BY580P 170S/840 DIA HE WB GC SI BR	IK07
910505102908	BY580P 170S/840 DIA HE ASYM GC SI BR	IK07
910505104550	BY580P 170S/840 DIA HE WB GC SI MSP BR	IK07
910505104562	BY580P 170S/840 DIA HE WBGCSICHEMBR1mCW5	IK07
910505104564	BY580P 170S/840 DIA HEWBGCSICHEMMBW1mCW5	IK07
910505102873	BY581P 250S/840 PSU WB GC SI	IK07
910505102875	BY581P 250S/840 PSU HE WB GC SI	IK07
910505102877	BY581P 200S/840 DIA UE WB GC SI	IK07
910505102880	BY581P 250S/840 DIA WB GC SI	IK07
910505102881	BY581P 350S/840 DIA WB GC SI	IK07
910505102884	BY581P 250S/840 DIA HE WB GC SI	IK07
910505102885	BY581P 350S/840 DIA HE WB GC SI	IK07
910505102887	BY581P 250S/840 DIA WB PC SI	IK07
910505102891	BY581P 250S/840 DIA HE WB PC SI	IK07
910505102895	BY581P 250S/840 DIA WB GC SI ELD3	IK07
910505102897	BY581P 250S/840 DIA HE WB GC SI ELD3	IK07
910505102901	BY581P 250S/840 DIA MB GC SI	IK07
910505102902	BY581P 350S/840 DIA MB GC SI	IK07
910505102905	BY581P 250S/840 DIA HE MB GC SI	IK07
910505102906	BY581P 350S/840 DIA HE MB GC SI	IK07
910505102915	BY581P 250S/840 DIA NB GC SI	IK07
910505102917	BY581P 250S/840 DIA HE NB GC SI	IK07
910505102919	BY581P 250S/840 DIA XNB GC SI	IK07
910505102921	BY581P 250S/840 DIA HE XNB GC SI	IK07
910505102923	BY581P 250S/840 DIA HRO GC SI	IK07
910505102925	BY581P 250S/840 DIA HE HRO GC SI	IK07
910505102927	BY581P 250S/865 DIA WB GC SI	IK07
910505102929	BY581P 250S/865 DIA HE WB GC SI	IK07
910505102931	BY581P 250S/830 DIA WB GC SI	IK07
910505102933	BY581P 250S/830 DIA HE WB GC SI	IK07
910505102935	BY581P 250S/940 DIA WB GC SI	IK07
910505102936	BY581P 250S/840 DIA HE WB GC SI XT 1m	IK07
910505102937	BY581P 350S/840 DIA HE WB GC SI XT 1m	IK07
910505104541	BY583P 250S/840 DIA HE WB GC SI 0.5m CW5	IK07
910505102856	BY580X 130S/840 SIA WB GC SI H4	IK03
910505102857	BY580X 170S/840 SIA WB GC SI H4	IK03
910505102860	BY580X 130S/840 SIA HE WB GC SI H4	IK03
910505102861	BY580X 170S/840 SIA HE WB GC SI H4	IK03

Emergency Operation (1/2)

Order Code	Full Product Name	Emergency lighting	Emergency flux	Type of emergency lighting battery	Power consumption during Central DC emergency mode	Order Code	Full Product Name	Emergency lighting	Emergency flux	Type of emergency lighting battery	Power consumption during Central DC emergency mode
910505102953	BY581P 700S/840 DIA WB GC SI	-	-	-	-	910505102867	BY580X 170S/840 SIA HE WB GC SI H4 BR	-	-	-	-
910505102954	BY581P 700S/840 DIA HE WB GC SI	-	-	-	-	910505104565	BY581P 250S/840 DIA HEWBGCSICHEMMBW1mCW5	-	-	-	-
910505102955	BY581P 700S/840 DIA WB GC SI BR	-	-	-	-	910505102872	BY580P 170S/840 PSU WB GC SI	-	-	-	-
910505102956	BY581P 700S/840 DIA HE WB GC SI BR	-	-	-	-	910505102874	BY580P 170S/840 PSU HE WB GC SI	-	-	-	-
910505102865	BY581X 250S/840 SIA WB GC SI H4 BR	-	-	-	-	910505102876	BY580P 100S/840 DIA UE WB GC SI	-	-	-	-
910505102866	BY581X 250S/840 SIA HE WB GC SI H4 BR	-	-	-	-	910505102878	BY580P 130S/840 DIA WB GC SI	-	-	-	-
910505102858	BY581X 250S/840 SIA WB GC SI H4	-	-	-	-	910505102879	BY580P 170S/840 DIA WB GC SI	-	-	-	-
910505102859	BY581X 350S/840 SIA WB GC SI H4	-	-	-	-	910505102882	BY580P 130S/840 DIA HE WB GC SI	-	-	-	-
910505102862	BY581X 250S/840 SIA HE WB GC SI H4	-	-	-	-	910505102883	BY580P 170S/840 DIA HE WB GC SI	-	-	-	-
910505102863	BY581X 350S/840 SIA HE WB GC SI H4	-	-	-	-	910505102886	BY580P 170S/840 DIA WB PC SI	-	-	-	-
910505102868	BY581X 250S/840 SIA WB GC SI ELP3 H4	Emergency lighting 3 hours duration Pro version	850 lm	Lithium	5 W	910505102890	BY580P 170S/840 DIA HE WB PC SI	-	-	-	-
910505102869	BY581X 250S/840 SIA WB GC SI ELW3 H4	Emergency lighting 3 hours duration with Wireless Interface	850 lm	Lithium	5 W	910505102894	BY580P 170S/840 DIA WB GC SI ELP3	Emergency lighting 3 hours duration Pro version	450 lm	Lithium	3 W
910505102870	BY581X 250S/840 SIA HE WB GC SI ELP3 H4	Emergency lighting 3 hours duration Pro version	850 lm	Lithium	5 W	910505102896	BY580P 170S/840 DIA HE WB GC SI ELP3	Emergency lighting 3 hours duration Pro version	450 lm	Lithium	3 W
910505102871	BY581X 250S/840 SIA HE WB GC SI ELW3 H4	Emergency lighting 3 hours duration with Wireless Interface	850 lm	Lithium	5 W	910505102898	BY580P 130S/840 DIA MB GC SI	-	-	-	-
910505102864	BY580X 170S/840 SIA WB GC SI H4 BR	-	-	-	-	910505102899	BY580P 170S/840 DIA MB GC SI	-	-	-	-
						910505102903	BY580P 130S/840 DIA HE MB GC SI	-	-	-	-
						910505102904	BY580P 170S/840 DIA HE MB GC SI	-	-	-	-
						910505102914	BY580P 170S/840 DIA NB GC SI	-	-	-	-
						910505102916	BY580P 170S/840 DIA HE NB GC SI	-	-	-	-
						910505102918	BY580P 170S/840 DIA XNB GC SI	-	-	-	-

Order Code	Full Product Name	Emergency lighting	Emergency flux	Type of emergency lighting battery	Power consumption during Central DC emergency mode	Order Code	Full Product Name	Emergency lighting	Emergency flux	Type of emergency lighting battery	Power consumption during Central DC emergency mode
910505102920	BY580P 170S/840 DIA HE XNB GC SI	-	-	-	-	910505102888	BY580P 170S/840 DIA WB GC SI BR	-	-	-	-
910505102922	BY580P 170S/840 DIA HRO GC SI	-	-	-	-	910505102892	BY580P 170S/840 DIA HE WB GC SI BR	-	-	-	-
910505102924	BY580P 170S/840 DIA HE HRO GC SI	-	-	-	-	910505102908	BY580P 170S/840 DIA HE ASYM GC SI BR	-	-	-	-
910505102926	BY580P 170S/865 DIA WB GC SI	-	-	-	-	910505104550	BY580P 170S/840 DIA HE WB GC SI MSP BR	-	-	-	-
910505102928	BY580P 170S/865 DIA HE WB GC SI	-	-	-	-	910505104562	BY580P 170S/840 DIA HE WBGCSICHEMBR1mCW5	-	-	-	-
910505102930	BY580P 170S/830 DIA WB GC SI	-	-	-	-	910505104564	BY580P 170S/840 DIA HEWBGCSICHEMBW1mCW5	-	-	-	-
910505102932	BY580P 170S/830 DIA HE WB GC SI	-	-	-	-	910505102873	BY581P 250S/840 PSU WB GC SI	-	-	-	-
910505102934	BY580P 170S/940 DIA WB GC SI	-	-	-	-	910505102875	BY581P 250S/840 PSU HE WB GC SI	-	-	-	-
910505104558	BY580X 170S/840 SIA WB GC SI IA9	-	-	-	-	910505102877	BY581P 200S/840 DIA UE WB GC SI	-	-	-	-
910505104560	BY580X 170S/840 SIA HE WB GC SI ELP3 IA9	-	-	-	-	910505102880	BY581P 250S/840 DIA WB GC SI	-	-	-	-
910505102910	BY580P 170S/840 DIA ASYM GC SI MBW	-	-	-	-	910505102881	BY581P 350S/840 DIA WB GC SI	-	-	-	-
910505102912	BY580P 170S/840 DIA HE ASYM GC SI MBW	-	-	-	-	910505102884	BY581P 250S/840 DIA HE WB GC SI	-	-	-	-
910505102889	BY581P 250S/840 DIA WB GC SI BR	-	-	-	-	910505102885	BY581P 350S/840 DIA HE WB GC SI	-	-	-	-
910505102893	BY581P 250S/840 DIA HE WB GC SI BR	-	-	-	-	910505102887	BY581P 250S/840 DIA WB PC SI	-	-	-	-
910505102907	BY581P 250S/840 DIA ASYM GC SI BR	-	-	-	-	910505102891	BY581P 250S/840 DIA HE WB PC SI	-	-	-	-
910505102909	BY581P 250S/840 DIA HE ASYM GC SI BR	-	-	-	-	910505102895	BY581P 250S/840 DIA WB GC SI ELD3	Emergency lighting 3 hours duration with DALI interface	850 lm	Lithium	5 W
910505102911	BY581P 250S/840 DIA ASYM GC SI MBW	-	-	-	-						
910505102913	BY581P 250S/840 DIA HE ASYM GC SI MBW	-	-	-	-						
910505102938	BY581P 350S/840 DIA HE WB GC SI BR XT 1m	-	-	-	-	910505102897	BY581P 250S/840 DIA HE WB GC SI ELD3	Emergency lighting 3 hours duration with DALI interface	850 lm	Lithium	5 W
910505104551	BY581P 250S/840 DIA HE WB GC SI MSP BR	-	-	-	-						
910505104559	BY581X 250S/840 SIA WB GC SI IA9	-	-	-	-						
910505104561	BY581X 250S/840 SIA HE WB GC SI ELP3 IA9	-	-	-	-	910505102901	BY581P 250S/840 DIA MB GC SI	-	-	-	-
910505104563	BY581P 250S/840 DIA HE WBGCSICHEMBR1mCW5	-	-	-	-	910505102902	BY581P 350S/840 DIA MB GC SI	-	-	-	-

Order Code	Full Product Name	Emergency lighting	Emergency flux	Type of emergency lighting	Power consumption during Central emergency mode	Order Code	Full Product Name	Emergency lighting	Emergency flux	Type of emergency lighting	Power consumption during Central DC emergency mode
910505102905	BY581P 250S/840 DIA HE MB GC SI	-	-	-	-	910505102931	BY581P 250S/830 DIA WB GC SI	-	-	-	-
910505102906	BY581P 350S/840 DIA HE MB GC SI	-	-	-	-	910505102933	BY581P 250S/830 DIA HE WB GC SI	-	-	-	-
910505102915	BY581P 250S/840 DIA NB GC SI	-	-	-	-	910505102935	BY581P 250S/940 DIA WB GC SI	-	-	-	-
910505102917	BY581P 250S/840 DIA HE NB GC SI	-	-	-	-	910505102936	BY581P 250S/840 DIA HE WB GC SI XT 1m	-	-	-	-
910505102919	BY581P 250S/840 DIA XNB GC SI	-	-	-	-	910505102937	BY581P 350S/840 DIA HE WB GC SI XT 1m	-	-	-	-
910505102921	BY581P 250S/840 DIA HE XNB GC SI	-	-	-	-	910505104541	BY583P 250S/840 DIA HE WB GC SI 0.5m CW5	-	-	-	-
910505102923	BY581P 250S/840 DIA HRO GC SI	-	-	-	-	910505102856	BY580X 130S/840 SIA WB GC SI H4	-	-	-	-
910505102925	BY581P 250S/840 DIA HE HRO GC SI	-	-	-	-	910505102857	BY580X 170S/840 SIA WB GC SI H4	-	-	-	-
910505102927	BY581P 250S/865 DIA WB GC SI	-	-	-	-	910505102860	BY580X 130S/840 SIA HE WB GC SI H4	-	-	-	-
910505102929	BY581P 250S/865 DIA HE WB GC SI	-	-	-	-	910505102861	BY580X 170S/840 SIA HE WB GC SI H4	-	-	-	-

Emergency Operation (2/2)

Order Code	Full Product Name	Rated duration of the emergency lighting (when fully charged)
910505102953	BY581P 700S/840 DIA WB GC SI	-
910505102954	BY581P 700S/840 DIA HE WB GC SI	-
910505102955	BY581P 700S/840 DIA WB GC SI BR	-
910505102956	BY581P 700S/840 DIA HE WB GC SI BR	-
910505102865	BY581X 250S/840 SIA WB GC SI H4 BR	-
910505102866	BY581X 250S/840 SIA HE WB GC SI H4 BR	-
910505102858	BY581X 250S/840 SIA WB GC SI H4	-
910505102859	BY581X 350S/840 SIA WB GC SI H4	-
910505102862	BY581X 250S/840 SIA HE WB GC SI H4	-
910505102863	BY581X 350S/840 SIA HE WB GC SI H4	-
910505102868	BY581X 250S/840 SIA WB GC SI ELP3 H4	3 hour(s)
910505102869	BY581X 250S/840 SIA WB GC SI ELW3 H4	3 hour(s)
910505102870	BY581X 250S/840 SIA HE WB GC SI ELP3 H4	3 hour(s)
910505102871	BY581X 250S/840 SIA HE WB GC SI ELW3 H4	3 hour(s)
910505102864	BY580X 170S/840 SIA WB GC SI H4 BR	-
910505102867	BY580X 170S/840 SIA HE WB GC SI H4 BR	-
910505104565	BY581P 250S/840 DIA HEWBGC SICHEMMBW1mCW5	-
910505102872	BY580P 170S/840 PSU WB GC SI	-
910505102874	BY580P 170S/840 PSU HE WB GC SI	-

Order Code	Full Product Name	Rated duration of the emergency lighting (when fully charged)
910505102876	BY580P 100S/840 DIA UE WB GC SI	-
910505102878	BY580P 130S/840 DIA WB GC SI	-
910505102879	BY580P 170S/840 DIA WB GC SI	-
910505102882	BY580P 130S/840 DIA HE WB GC SI	-
910505102883	BY580P 170S/840 DIA HE WB GC SI	-
910505102886	BY580P 170S/840 DIA WB PC SI	-
910505102890	BY580P 170S/840 DIA HE WB PC SI	-
910505102894	BY580P 170S/840 DIA WB GC SI ELP3	3 hour(s)
910505102896	BY580P 170S/840 DIA HE WB GC SI ELP3	3 hour(s)
910505102898	BY580P 130S/840 DIA MB GC SI	-
910505102899	BY580P 170S/840 DIA MB GC SI	-
910505102903	BY580P 130S/840 DIA HE MB GC SI	-
910505102904	BY580P 170S/840 DIA HE MB GC SI	-
910505102914	BY580P 170S/840 DIA NB GC SI	-
910505102916	BY580P 170S/840 DIA HE NB GC SI	-
910505102918	BY580P 170S/840 DIA XNB GC SI	-
910505102920	BY580P 170S/840 DIA HE XNB GC SI	-
910505102922	BY580P 170S/840 DIA HRO GC SI	-
910505102924	BY580P 170S/840 DIA HE HRO GC SI	-

Order Code	Full Product Name	Rated duration of the emergency lighting (when fully charged)
910505102926	BY580P 170S/865 DIA WB GC SI	-
910505102928	BY580P 170S/865 DIA HE WB GC SI	-
910505102930	BY580P 170S/830 DIA WB GC SI	-
910505102932	BY580P 170S/830 DIA HE WB GC SI	-
910505102934	BY580P 170S/940 DIA WB GC SI	-
910505104558	BY580X 170S/840 SIA WB GC SI IA9	-
910505104560	BY580X 170S/840 SIA HE WB GC SI ELP3 IA9	-
910505102910	BY580P 170S/840 DIA ASYM GC SI MBW	-
910505102912	BY580P 170S/840 DIA HE ASYM GC SI MBW	-
910505102889	BY581P 250S/840 DIA WB GC SI BR	-
910505102893	BY581P 250S/840 DIA HE WB GC SI BR	-
910505102907	BY581P 250S/840 DIA ASYM GC SI BR	-
910505102909	BY581P 250S/840 DIA HE ASYM GC SI BR	-
910505102911	BY581P 250S/840 DIA ASYM GC SI MBW	-
910505102913	BY581P 250S/840 DIA HE ASYM GC SI MBW	-
910505102938	BY581P 350S/840 DIA HE WB GC SI BR XT 1m	-
910505104551	BY581P 250S/840 DIA HE WB GC SI MSP BR	-
910505104559	BY581X 250S/840 SIA WB GC SI IA9	-
910505104561	BY581X 250S/840 SIA HE WB GC SI ELP3 IA9	-
910505104563	BY581P 250S/840 DIA HE WBGCSICHEMBR1mCW5	-
910505102888	BY580P 170S/840 DIA WB GC SI BR	-
910505102892	BY580P 170S/840 DIA HE WB GC SI BR	-
910505102908	BY580P 170S/840 DIA HE ASYM GC SI BR	-
910505104550	BY580P 170S/840 DIA HE WB GC SI MSP BR	-
910505104562	BY580P 170S/840 DIA HE WBGCSICHEMBR1mCW5	-
910505104564	BY580P 170S/840 DIA HEWBGCSICHEMBW1mCW5	-
910505102873	BY581P 250S/840 PSU WB GC SI	-
910505102875	BY581P 250S/840 PSU HE WB GC SI	-
910505102877	BY581P 200S/840 DIA UE WB GC SI	-
910505102880	BY581P 250S/840 DIA WB GC SI	-

Order Code	Full Product Name	Rated duration of the emergency lighting (when fully charged)
910505102881	BY581P 350S/840 DIA WB GC SI	-
910505102884	BY581P 250S/840 DIA HE WB GC SI	-
910505102885	BY581P 350S/840 DIA HE WB GC SI	-
910505102887	BY581P 250S/840 DIA WB PC SI	-
910505102891	BY581P 250S/840 DIA HE WB PC SI	-
910505102895	BY581P 250S/840 DIA WB GC SI ELD3	3 hour(s)
910505102897	BY581P 250S/840 DIA HE WB GC SI ELD3	3 hour(s)
910505102901	BY581P 250S/840 DIA MB GC SI	-
910505102902	BY581P 350S/840 DIA MB GC SI	-
910505102905	BY581P 250S/840 DIA HE MB GC SI	-
910505102906	BY581P 350S/840 DIA HE MB GC SI	-
910505102915	BY581P 250S/840 DIA NB GC SI	-
910505102917	BY581P 250S/840 DIA HE NB GC SI	-
910505102919	BY581P 250S/840 DIA XNB GC SI	-
910505102921	BY581P 250S/840 DIA HE XNB GC SI	-
910505102923	BY581P 250S/840 DIA HRO GC SI	-
910505102925	BY581P 250S/840 DIA HE HRO GC SI	-
910505102927	BY581P 250S/865 DIA WB GC SI	-
910505102929	BY581P 250S/865 DIA HE WB GC SI	-
910505102931	BY581P 250S/830 DIA WB GC SI	-
910505102933	BY581P 250S/830 DIA HE WB GC SI	-
910505102935	BY581P 250S/940 DIA WB GC SI	-
910505102936	BY581P 250S/840 DIA HE WB GC SI XT 1m	-
910505102937	BY581P 350S/840 DIA HE WB GC SI XT 1m	-
910505104541	BY583P 250S/840 DIA HE WB GC SI 0.5m CW5	-
910505102856	BY580X 130S/840 SIA WB GC SI H4	-
910505102857	BY580X 170S/840 SIA WB GC SI H4	-
910505102860	BY580X 130S/840 SIA HE WB GC SI H4	-
910505102861	BY580X 170S/840 SIA HE WB GC SI H4	-

Approval and Application

Order Code	Full Product Name	Ambient temperature range	Glow-wire test	Flickering value (PstLM) - Flickering value as per EN 61000-3-3		Order Code	Full Product Name	Ambient temperature range	Glow-wire test	Flickering value (PstLM) - Flickering value as per EN 61000-3-3	
				(SV)	Stroboscopic effect visibility measure (SVM)					(SV)	Stroboscopic effect visibility measure (SVM)
910505102953	BY581P 700S/840 DIA WB GC SI	-30 to +55 °C	Temperature 650 °C, duration 30 s	0.22	0.01	910505102955	BY581P 700S/840 DIA WB GC SI BR	-30 to +55 °C	Temperature 650 °C, duration 30 s	0.22	0.01
910505102954	BY581P 700S/840 DIA HE WB GC SI	-30 to +55 °C	Temperature 650 °C, duration 30 s	0.22	0.01	910505102956	BY581P 700S/840 DIA HE WB GC SI BR	-30 to +55 °C	Temperature 650 °C, duration 30 s	0.22	0.01

Order Code	Full Product Name	Ambient temperature range	Glow-wire test	Flickering value (PstLM) - Strc Flickering effect		Order Code	Full Product Name	Ambient temperature range	Glow-wire test	Flickering value (PstLM) - Strobosc effect	
				value as per EN 61000-3-3 (SV)	visi me:					value as per EN 61000-3-3 (SVM)	visibility measure
910505102865	BY581X 250S/840 SIA WB GC SI H4 BR	-30 to +55 °C	Temperature 650 °C, duration 30 s	1	0.4						
						910505104565	BY581P 250S/840 DIA HEWBGCSICHEMMBW1mCW5	-30 to +55 °C	Temperature 650 °C, duration 30 s	0.12	0.07
910505102866	BY581X 250S/840 SIA HE WB GC SI H4 BR	-30 to +55 °C	Temperature 650 °C, duration 30 s	1	0.4						
						910505102872	BY580P 170S/840 PSU WB GC SI	-30 to +55 °C	Temperature 650 °C, duration 30 s	0.04	0.07
910505102858	BY581X 250S/840 SIA WB GC SI H4	-30 to +55 °C	Temperature 650 °C, duration 30 s	1	0.4						
						910505102874	BY580P 170S/840 PSU HE WB GC SI	-30 to +55 °C	Temperature 650 °C, duration 30 s	0.04	0.07
910505102859	BY581X 350S/840 SIA WB GC SI H4	-30 to +55 °C	Temperature 650 °C, duration 30 s	1	0.4						
						910505102876	BY580P 100S/840 DIA UE WB GC SI	-30 to +55 °C	Temperature 650 °C, duration 30 s	-	-
910505102862	BY581X 250S/840 SIA HE WB GC SI H4	-30 to +55 °C	Temperature 650 °C, duration 30 s	1	0.4						
						910505102878	BY580P 130S/840 DIA WB GC SI	-30 to +55 °C	Temperature 650 °C, duration 30 s	-	-
910505102863	BY581X 350S/840 SIA HE WB GC SI H4	-30 to +55 °C	Temperature 650 °C, duration 30 s	1	0.4						
						910505102879	BY580P 170S/840 DIA WB GC SI	-30 to +55 °C	Temperature 650 °C, duration 30 s	0.12	0.07
910505102868	BY581X 250S/840 SIA WB GC SI ELP3 H4	0 °C to 25 °C	Temperature 850 °C, duration 30 s	1	0.4						
						910505102882	BY580P 130S/840 DIA HE WB GC SI	-30 to +55 °C	Temperature 650 °C, duration 30 s	-	-
910505102869	BY581X 250S/840 SIA WB GC SI ELW3 H4	0 °C to 25 °C	Temperature 850 °C, duration 30 s	1	0.4						
						910505102883	BY580P 170S/840 DIA HE WB GC SI	-30 to +55 °C	Temperature 650 °C, duration 30 s	-	-
910505102870	BY581X 250S/840 SIA HE WB GC SI ELP3 H4	0 °C to 25 °C	Temperature 850 °C, duration 30 s	1	0.4						
						910505102886	BY580P 170S/840 DIA WB PC SI	-30 to +55 °C	Temperature 650 °C, duration 30 s	0.12	0.07
910505102871	BY581X 250S/840 SIA HE WB GC SI ELW3 H4	0 °C to 25 °C	Temperature 850 °C, duration 30 s	1	0.4						
						910505102890	BY580P 170S/840 DIA HE WB PC SI	-30 to +55 °C	Temperature 650 °C, duration 30 s	-	-
910505102864	BY580X 170S/840 SIA WB GC SI H4 BR	-30 to +55 °C	Temperature 650 °C, duration 30 s	1	0.4						
						910505102894	BY580P 170S/840 DIA WB GC SI ELP3	0 °C to 25 °C	Temperature 850 °C, duration 30 s	0.12	0.07
910505102867	BY580X 170S/840 SIA HE WB GC SI H4 BR	-30 to +55 °C	Temperature 650 °C, duration 30 s	1	0.4						

Order Code	Full Product Name	Ambient temperature range	Glow-wire test	Flickering value (PstLM) - Strc Flickering effect		Order Code	Full Product Name	Ambient temperature range	Glow-wire test	Flickering value (PstLM) - Stroboscopic effect		
				value as per EN 61000-3-3 (SV)	visibility					value as per EN 61000-3-3 (SVM)	visibility measure	
910505102896	BY580P 170S/840 DIA HE WB GC SI ELP3	0 °C to 25 °C	Temperature - 850 °C, duration 30 s	-	-					duration 30 s		
910505102898	BY580P 130S/840 DIA MB GC SI	-30 to +55 °C	Temperature - 650 °C, duration 30 s	-	-	910505102928	BY580P 170S/865 DIA HE WB GC SI	-30 to +55 °C	Temperature - 650 °C, duration 30 s	-	-	
910505102899	BY580P 170S/840 DIA MB GC SI	-30 to +55 °C	Temperature - 650 °C, duration 30 s	0.12	0.07	910505102930	BY580P 170S/830 DIA WB GC SI	-30 to +55 °C	Temperature - 650 °C, duration 30 s	0.12	0.07	
910505102903	BY580P 130S/840 DIA HE MB GC SI	-30 to +55 °C	Temperature - 650 °C, duration 30 s	-	-	910505102932	BY580P 170S/830 DIA HE WB GC SI	-30 to +55 °C	Temperature - 650 °C, duration 30 s	-	-	
910505102904	BY580P 170S/840 DIA HE MB GC SI	-30 to +55 °C	Temperature - 650 °C, duration 30 s	-	-	910505102934	BY580P 170S/940 DIA WB GC SI	-30 to +55 °C	Temperature - 650 °C, duration 30 s	0.12	0.07	
910505102914	BY580P 170S/840 DIA NB GC SI	-30 to +55 °C	Temperature - 650 °C, duration 30 s	-	-	910505104558	BY580X 170S/840 SIA WB GC SI IA9	-30 to +55 °C	Temperature - 650 °C, duration 30 s	1	0.4	
910505102916	BY580P 170S/840 DIA HE NB GC SI	-30 to +55 °C	Temperature - 650 °C, duration 30 s	-	-	910505104560	BY580X 170S/840 SIA HE WB GC SI ELP3 IA9	-30 to +55 °C	Temperature - 650 °C, duration 30 s	1	0.4	
910505102918	BY580P 170S/840 DIA XNB GC SI	-30 to +55 °C	Temperature - 650 °C, duration 30 s	0.12	0.07	910505102910	BY580P 170S/840 DIA ASYM GC SI MBW	-30 to +55 °C	Temperature - 650 °C, duration 30 s	0.12	0.07	
910505102920	BY580P 170S/840 DIA HE XNB GC SI	-30 to +55 °C	Temperature - 650 °C, duration 30 s	-	-	910505102912	BY580P 170S/840 DIA HE ASYM GC SI MBW	-30 to +55 °C	Temperature - 650 °C, duration 30 s	-	-	
910505102922	BY580P 170S/840 DIA HRO GC SI	-30 to +55 °C	Temperature - 650 °C, duration 30 s	0.12	0.07	910505102889	BY581P 250S/840 DIA WB GC SI BR	-30 to +55 °C	Temperature - 650 °C, duration 30 s	0.12	0.07	
910505102924	BY580P 170S/840 DIA HE HRO GC SI	-30 to +55 °C	Temperature - 650 °C, duration 30 s	-	-	910505102893	BY581P 250S/840 DIA HE WB GC SI BR	-30 to +55 °C	Temperature - 650 °C, duration 30 s	0.12	0.07	
910505102926	BY580P 170S/865 DIA WB GC SI	-30 to +55 °C	Temperature - 650 °C, duration 30 s	0.12	0.07	910505102907	BY581P 250S/840 DIA ASYM GC SI BR	-30 to +55 °C	Temperature - 650 °C, duration 30 s	0.12	0.07	

Order Code	Full Product Name	Ambient temperature range	Glow-wire test	Flickering value (PstLM) - Strc Flickering effect		Order Code	Full Product Name	Ambient temperature range	Glow-wire test	Flickering value (PstLM) - Stroboscopic effect	
				value as per EN 61000-3-3 (SV)	visibility					value as per EN 61000-3-3 (SVM)	visibility measure
910505102909	BY581P 250S/840 DIA HE ASYM GC SI BR	-30 to +55 °C	Temperature 650 °C, duration 30 s	0.12	0.07						
						910505104562	BY580P 170S/840 DIA HE WBGCSICHEMBR1mCW5	-30 to +55 °C	Temperature 650 °C, duration 30 s	0.12	0.07
910505102911	BY581P 250S/840 DIA ASYM GC SI MBW	-30 to +55 °C	Temperature 650 °C, duration 30 s	0.12	0.07						
						910505104564	BY580P 170S/840 DIA HEWBGCSICHEMMBW1mCW5	-30 to +55 °C	Temperature 650 °C, duration 30 s	-	-
910505102913	BY581P 250S/840 DIA HE ASYM GC SI MBW	-30 to +55 °C	Temperature 650 °C, duration 30 s	0.12	0.07						
						910505102873	BY581P 250S/840 PSU WB GC SI	-30 to +55 °C	Temperature 650 °C, duration 30 s	0.04	0.07
910505102938	BY581P 350S/840 DIA HE WB GC SI BR XT 1m	-30 °C to 55 °C	Temperature 650 °C, duration 30 s	0.22	0.01						
						910505102875	BY581P 250S/840 PSU HE WB GC SI	-30 to +55 °C	Temperature 650 °C, duration 30 s	0.04	0.07
910505104551	BY581P 250S/840 DIA HE WB GC SI MSP BR	-30 to +55 °C	Temperature 650 °C, duration 30 s	0.12	0.07						
						910505102877	BY581P 200S/840 DIA UE WB GC SI	-30 to +55 °C	Temperature 650 °C, duration 30 s	0.12	0.07
910505104559	BY581X 250S/840 SIA WB GC SI IA9	-30 to +55 °C	Temperature 650 °C, duration 30 s	1	0.4						
						910505102880	BY581P 250S/840 DIA WB GC SI	-30 to +55 °C	Temperature 650 °C, duration 30 s	0.12	0.07
910505104561	BY581X 250S/840 SIA HE WB GC SI ELP3 IA9	-30 to +55 °C	Temperature 650 °C, duration 30 s	1	0.4						
						910505102881	BY581P 350S/840 DIA WB GC SI	-30 to +55 °C	Temperature 650 °C, duration 30 s	0.22	0.01
910505104563	BY581P 250S/840 DIA HE WBGCSICHEMBR1mCW5	-30 to +55 °C	Temperature 650 °C, duration 30 s	0.12	0.07						
						910505102884	BY581P 250S/840 DIA HE WB GC SI	-30 to +55 °C	Temperature 650 °C, duration 30 s	0.12	0.07
910505102888	BY580P 170S/840 DIA WB GC SI BR	-30 to +55 °C	Temperature 650 °C, duration 30 s	0.12	0.07						
						910505102885	BY581P 350S/840 DIA HE WB GC SI	-30 to +55 °C	Temperature 650 °C, duration 30 s	0.22	0.01
910505102892	BY580P 170S/840 DIA HE WB GC SI BR	-30 to +55 °C	Temperature 650 °C, duration 30 s	-	-						
						910505102887	BY581P 250S/840 DIA WB PC SI	-30 to +55 °C	Temperature 650 °C, duration 30 s	0.12	0.07
910505102908	BY580P 170S/840 DIA HE ASYM GC SI BR	-30 to +55 °C	Temperature 650 °C, duration 30 s	-	-						
						910505102891	BY581P 250S/840 DIA HE WB PC SI	-30 to +55 °C	Temperature 650 °C, duration 30 s	0.12	0.07
910505104550	BY580P 170S/840 DIA HE WB GC SI MSP BR	-30 to +55 °C	Temperature 650 °C, duration 30 s	-	-						

Order Code	Full Product Name	Ambient temperature range	Glow-wire test	Flickering value (PstLM) - Strc Flickering effect		Order Code	Full Product Name	Ambient temperature range	Glow-wire test	Flickering value (PstLM) - Stroboscopic effect	
				value as per EN 61000-3-3 (SV)	visibility					value as per EN 61000-3-3 (SVM)	visibility measure
910505102895	BY581P 250S/840 DIA WB GC SI ELD3	0 °C to 25 °C	Temperature 850 °C, duration 30 s	0.12	0.07						
						910505102927	BY581P 250S/865 DIA WB GC SI	-30 to +55 °C	Temperature 650 °C, duration 30 s	0.12	0.07
910505102897	BY581P 250S/840 DIA HE WB GC SI ELD3	0 °C to 25 °C	Temperature 850 °C, duration 30 s	0.12	0.07						
						910505102929	BY581P 250S/865 DIA HE WB GC SI	-30 to +55 °C	Temperature 650 °C, duration 30 s	0.12	0.07
910505102901	BY581P 250S/840 DIA MB GC SI	-30 to +55 °C	Temperature 650 °C, duration 30 s	0.12	0.07						
						910505102931	BY581P 250S/830 DIA WB GC SI	-30 to +55 °C	Temperature 650 °C, duration 30 s	0.12	0.07
910505102902	BY581P 350S/840 DIA MB GC SI	-30 to +55 °C	Temperature 650 °C, duration 30 s	0.22	0.01						
						910505102933	BY581P 250S/830 DIA HE WB GC SI	-30 to +55 °C	Temperature 650 °C, duration 30 s	0.12	0.07
910505102905	BY581P 250S/840 DIA HE MB GC SI	-30 to +55 °C	Temperature 650 °C, duration 30 s	0.12	0.07						
						910505102935	BY581P 250S/940 DIA WB GC SI	-30 to +55 °C	Temperature 650 °C, duration 30 s	0.12	0.07
910505102906	BY581P 350S/840 DIA HE MB GC SI	-30 to +55 °C	Temperature 650 °C, duration 30 s	0.22	0.01						
						910505102936	BY581P 250S/840 DIA HE WB GC SI XT 1m	-30 °C to 65 °C	Temperature 650 °C, duration 30 s	0.12	0.07
910505102915	BY581P 250S/840 DIA NB GC SI	-30 to +55 °C	Temperature 650 °C, duration 30 s	0.12	0.07						
						910505102937	BY581P 350S/840 DIA HE WB GC SI XT 1m	-30 °C to 55 °C	Temperature 650 °C, duration 30 s	0.22	0.01
910505102917	BY581P 250S/840 DIA HE NB GC SI	-30 to +55 °C	Temperature 650 °C, duration 30 s	0.12	0.07						
						910505104541	BY583P 250S/840 DIA HE WB GC SI 0.5m CW5	-30 to +55 °C	Temperature 650 °C, duration 30 s	0.12	0.07
910505102919	BY581P 250S/840 DIA XNB GC SI	-30 to +55 °C	Temperature 650 °C, duration 30 s	0.12	0.07						
						910505102856	BY580X 130S/840 SIA WB GC SI H4	-30 to +55 °C	Temperature 650 °C, duration 30 s	1	0.4
910505102921	BY581P 250S/840 DIA HE XNB GC SI	-30 to +55 °C	Temperature 650 °C, duration 30 s	0.12	0.07						
						910505102857	BY580X 170S/840 SIA WB GC SI H4	-30 to +55 °C	Temperature 650 °C, duration 30 s	1	0.4
910505102923	BY581P 250S/840 DIA HRO GC SI	-30 to +55 °C	Temperature 650 °C, duration 30 s	0.12	0.07						
						910505102860	BY580X 130S/840 SIA HE WB GC SI H4	-30 to +55 °C	Temperature 650 °C, duration 30 s	1	0.4
910505102925	BY581P 250S/840 DIA HE HRO GC SI	-30 to +55 °C	Temperature 650 °C, duration 30 s	0.12	0.07						

Order Code	Full Product Name	Ambient temperature range	Glow-wire test	Flickering value (PstLM) - Flickering value as per EN 61000-3-3 (SV)	Stroboscopic effect visibility measure (SVM)	Order Code	Full Product Name	Ambient temperature range	Glow-wire test	Flickering value (PstLM) - Flickering value as per EN 61000-3-3 (SV)	Stroboscopic effect visibility measure (SVM)
910505102861	BY580X 170S/840 SIA HE WB GC SI H4	-30 to +55 °C	Temperature 1 650 °C,	0.4							

**Initial Performance (IEC Compliant)**

Order Code	Full Product Name	Initial chromaticity	Order Code	Full Product Name	Initial chromaticity
910505102953	BY581P 700S/840 DIA WB GC SI	(0.380, 0.375) SDCM 3	910505102878	BY580P 130S/840 DIA WB GC SI	(0.380, 0.375) SDCM 3
910505102954	BY581P 700S/840 DIA HE WB GC SI	(0.383, 0.377) SDCM 3	910505102879	BY580P 170S/840 DIA WB GC SI	(0.380, 0.375) SDCM 3
910505102955	BY581P 700S/840 DIA WB GC SI BR	(0.380, 0.375) SDCM 3	910505102882	BY580P 130S/840 DIA HE WB GC SI	(0.383, 0.377) SDCM 3
910505102956	BY581P 700S/840 DIA HE WB GC SI BR	(0.383, 0.377) SDCM 3	910505102883	BY580P 170S/840 DIA HE WB GC SI	(0.383, 0.377) SDCM 3
910505102865	BY581X 250S/840 SIA WB GC SI H4 BR	(0.380, 0.375) SDCM 3	910505102886	BY580P 170S/840 DIA WB PC SI	(0.380, 0.375) SDCM 3
910505102866	BY581X 250S/840 SIA HE WB GC SI H4 BR	(0.383, 0.377) SDCM 3	910505102890	BY580P 170S/840 DIA HE WB PC SI	(0.383, 0.377) SDCM 3
910505102858	BY581X 250S/840 SIA WB GC SI H4	(0.380, 0.375) SDCM 3	910505102894	BY580P 170S/840 DIA WB GC SI ELP3	(0.380, 0.375) SDCM 3
910505102859	BY581X 350S/840 SIA WB GC SI H4	(0.380, 0.375) SDCM 3	910505102896	BY580P 170S/840 DIA HE WB GC SI ELP3	(0.383, 0.377) SDCM 3
910505102862	BY581X 250S/840 SIA HE WB GC SI H4	(0.383, 0.377) SDCM 3	910505102898	BY580P 130S/840 DIA MB GC SI	(0.380, 0.375) SDCM 3
910505102863	BY581X 350S/840 SIA HE WB GC SI H4	(0.383, 0.377) SDCM 3	910505102899	BY580P 170S/840 DIA MB GC SI	(0.380, 0.375) SDCM 3
910505102868	BY581X 250S/840 SIA WB GC SI ELP3 H4	(0.380, 0.375) SDCM 3	910505102903	BY580P 130S/840 DIA HE MB GC SI	(0.383, 0.377) SDCM 3
910505102869	BY581X 250S/840 SIA WB GC SI ELW3 H4	(0.380, 0.375) SDCM 3	910505102904	BY580P 170S/840 DIA HE MB GC SI	(0.383, 0.377) SDCM 3
910505102870	BY581X 250S/840 SIA HE WB GC SI ELP3 H4	(0.383, 0.377) SDCM 3	910505102914	BY580P 170S/840 DIA NB GC SI	(0.380, 0.375) SDCM 3
910505102871	BY581X 250S/840 SIA HE WB GC SI ELW3 H4	(0.383, 0.377) SDCM 3	910505102916	BY580P 170S/840 DIA HE NB GC SI	(0.383, 0.377) SDCM 3
910505102864	BY580X 170S/840 SIA WB GC SI H4 BR	(0.380, 0.375) SDCM 3	910505102918	BY580P 170S/840 DIA XNB GC SI	(0.380, 0.375) SDCM 3
910505102867	BY580X 170S/840 SIA HE WB GC SI H4 BR	(0.383, 0.377) SDCM 3	910505102920	BY580P 170S/840 DIA HE XNB GC SI	(0.383, 0.377) SDCM 3
910505104565	BY581P 250S/840 DIA HEWBGCSCICHEMMBW1mCW5	(0.383, 0.377) SDCM 3	910505102922	BY580P 170S/840 DIA HRO GC SI	(0.380, 0.375) SDCM 3
910505102872	BY580P 170S/840 PSU WB GC SI	(0.380, 0.375) SDCM 3	910505102924	BY580P 170S/840 DIA HE HRO GC SI	(0.383, 0.377) SDCM 3
910505102874	BY580P 170S/840 PSU HE WB GC SI	(0.383, 0.377) SDCM 3	910505102926	BY580P 170S/865 DIA WB GC SI	(0.312, 0.327) SDCM 3
910505102876	BY580P 100S/840 DIA UE WB GC SI	(0.383, 0.377) SDCM 3	910505102928	BY580P 170S/865 DIA HE WB GC SI	(0.312, 0.325) SDCM 3
			910505102930	BY580P 170S/830 DIA WB GC SI	(0.432, 0.400) SDCM 3

Order Code	Full Product Name	Initial chromaticity
910505102932	BY580P 170S/830 DIA HE WB GC SI	(0.435, 0.401) SDCM 3
910505102934	BY580P 170S/940 DIA WB GC SI	(0.380, 0.375) SDCM 3
910505104558	BY580X 170S/840 SIA WB GC SI IA9	(0.380, 0.375) SDCM 3
910505104560	BY580X 170S/840 SIA HE WB GC SI ELP3 IA9	(0.383, 0.377) SDCM 3
910505102910	BY580P 170S/840 DIA ASYM GC SI MBW	(0.380, 0.375) SDCM 3
910505102912	BY580P 170S/840 DIA HE ASYM GC SI MBW	(0.383, 0.377) SDCM 3
910505102889	BY581P 250S/840 DIA WB GC SI BR	(0.380, 0.375) SDCM 3
910505102893	BY581P 250S/840 DIA HE WB GC SI BR	(0.383, 0.377) SDCM 3
910505102907	BY581P 250S/840 DIA ASYM GC SI BR	(0.380, 0.375) SDCM 3
910505102909	BY581P 250S/840 DIA HE ASYM GC SI BR	(0.383, 0.377) SDCM 3
910505102911	BY581P 250S/840 DIA ASYM GC SI MBW	(0.380, 0.375) SDCM 3
910505102913	BY581P 250S/840 DIA HE ASYM GC SI MBW	(0.383, 0.377) SDCM 3
910505102938	BY581P 350S/840 DIA HE WB GC SI BR XT 1m	(0.383, 0.377) SDCM 3
910505104551	BY581P 250S/840 DIA HE WB GC SI MSP BR	(0.383, 0.377) SDCM 3
910505104559	BY581X 250S/840 SIA WB GC SI IA9	(0.380, 0.375) SDCM 3
910505104561	BY581X 250S/840 SIA HE WB GC SI ELP3 IA9	(0.383, 0.377) SDCM 3
910505104563	BY581P 250S/840 DIA HE WBGCSICHEMBR1mCW5	(0.383, 0.377) SDCM 3
910505102888	BY580P 170S/840 DIA WB GC SI BR	(0.380, 0.375) SDCM 3
910505102892	BY580P 170S/840 DIA HE WB GC SI BR	(0.383, 0.377) SDCM 3
910505102908	BY580P 170S/840 DIA HE ASYM GC SI BR	(0.383, 0.377) SDCM 3
910505104550	BY580P 170S/840 DIA HE WB GC SI MSP BR	(0.383, 0.377) SDCM 3
910505104562	BY580P 170S/840 DIA HE WBGCSICHEMBR1mCW5	(0.383, 0.377) SDCM 3
910505104564	BY580P 170S/840 DIA HEWBGCSICHEMMBW1mCW5	(0.383, 0.377) SDCM 3
910505102873	BY581P 250S/840 PSU WB GC SI	(0.380, 0.375) SDCM 3
910505102875	BY581P 250S/840 PSU HE WB GC SI	(0.383, 0.377) SDCM 3
910505102877	BY581P 200S/840 DIA UE WB GC SI	(0.383, 0.377) SDCM 3

Order Code	Full Product Name	Initial chromaticity
910505102880	BY581P 250S/840 DIA WB GC SI	(0.380, 0.375) SDCM 3
910505102881	BY581P 350S/840 DIA WB GC SI	(0.380, 0.375) SDCM 3
910505102884	BY581P 250S/840 DIA HE WB GC SI	(0.383, 0.377) SDCM 3
910505102885	BY581P 350S/840 DIA HE WB GC SI	(0.383, 0.377) SDCM 3
910505102887	BY581P 250S/840 DIA WB PC SI	(0.380, 0.375) SDCM 3
910505102891	BY581P 250S/840 DIA HE WB PC SI	(0.383, 0.377) SDCM 3
910505102895	BY581P 250S/840 DIA WB GC SI ELD3	(0.380, 0.375) SDCM 3
910505102897	BY581P 250S/840 DIA HE WB GC SI ELD3	(0.383, 0.377) SDCM 3
910505102901	BY581P 250S/840 DIA MB GC SI	(0.380, 0.375) SDCM 3
910505102902	BY581P 350S/840 DIA MB GC SI	(0.380, 0.375) SDCM 3
910505102905	BY581P 250S/840 DIA HE MB GC SI	(0.383, 0.377) SDCM 3
910505102906	BY581P 350S/840 DIA HE MB GC SI	(0.383, 0.377) SDCM 3
910505102915	BY581P 250S/840 DIA NB GC SI	(0.380, 0.375) SDCM 3
910505102917	BY581P 250S/840 DIA HE NB GC SI	(0.383, 0.377) SDCM 3
910505102919	BY581P 250S/840 DIA XNB GC SI	(0.380, 0.375) SDCM 3
910505102921	BY581P 250S/840 DIA HE XNB GC SI	(0.383, 0.377) SDCM 3
910505102923	BY581P 250S/840 DIA HRO GC SI	(0.380, 0.375) SDCM 3
910505102925	BY581P 250S/840 DIA HE HRO GC SI	(0.383, 0.377) SDCM 3
910505102927	BY581P 250S/865 DIA WB GC SI	(0.312, 0.327) SDCM 3
910505102929	BY581P 250S/865 DIA HE WB GC SI	(0.312, 0.325) SDCM 3
910505102931	BY581P 250S/830 DIA WB GC SI	(0.432, 0.400) SDCM 3
910505102933	BY581P 250S/830 DIA HE WB GC SI	(0.435, 0.401) SDCM 3
910505102935	BY581P 250S/940 DIA WB GC SI	(0.380, 0.375) SDCM 3
910505102936	BY581P 250S/840 DIA HE WB GC SI XT 1m	(0.383, 0.377) SDCM 3
910505102937	BY581P 350S/840 DIA HE WB GC SI XT 1m	(0.383, 0.377) SDCM 3
910505104541	BY583P 250S/840 DIA HE WB GC SI 0.5m CW5	(0.380, 0.375) SDCM 3
910505102856	BY580X 130S/840 SIA WB GC SI H4	(0.380, 0.375) SDCM 3

Order Code	Full Product Name	Initial chromaticity
910505102857	BY580X 170S/840 SIA WB GC SI H4	(0.380, 0.375) SDCM 3
910505102860	BY580X 130S/840 SIA HE WB GC SI H4	(0.383, 0.377) SDCM 3

Order Code	Full Product Name	Initial chromaticity
910505102861	BY580X 170S/840 SIA HE WB GC SI H4	(0.383, 0.377) SDCM 3

## Product Data

Order Code	Full Product Name	Product family code
910505102953	BY581P 700S/840 DIA WB GC SI	BY581P
910505102954	BY581P 700S/840 DIA HE WB GC SI	BY581P
910505102955	BY581P 700S/840 DIA WB GC SI BR	BY581P
910505102956	BY581P 700S/840 DIA HE WB GC SI BR	BY581P
910505102865	BY581X 250S/840 SIA WB GC SI H4 BR	BY580X
910505102866	BY581X 250S/840 SIA HE WB GC SI H4 BR	BY581X
910505102858	BY581X 250S/840 SIA WB GC SI H4	BY580X
910505102859	BY581X 350S/840 SIA WB GC SI H4	BY581X
910505102862	BY581X 250S/840 SIA HE WB GC SI H4	BY581X
910505102863	BY581X 350S/840 SIA HE WB GC SI H4	BY581X
910505102868	BY581X 250S/840 SIA WB GC SI ELP3 H4	BY581X
910505102869	BY581X 250S/840 SIA WB GC SI ELW3 H4	BY581X
910505102870	BY581X 250S/840 SIA HE WB GC SI ELP3 H4	BY581X
910505102871	BY581X 250S/840 SIA HE WB GC SI ELW3 H4	BY581X
910505102864	BY580X 170S/840 SIA WB GC SI H4 BR	BY580X
910505102867	BY580X 170S/840 SIA HE WB GC SI H4 BR	BY580X
910505104565	BY581P 250S/840 DIA HEWBGCSICHEMMBW1mCW5	BY581P
910505102872	BY580P 170S/840 PSU WB GC SI	BY580P
910505102874	BY580P 170S/840 PSU HE WB GC SI	BY580P
910505102876	BY580P 100S/840 DIA UE WB GC SI	BY580P
910505102878	BY580P 130S/840 DIA WB GC SI	BY580P
910505102879	BY580P 170S/840 DIA WB GC SI	BY580P
910505102882	BY580P 130S/840 DIA HE WB GC SI	BY580P
910505102883	BY580P 170S/840 DIA HE WB GC SI	BY580P
910505102886	BY580P 170S/840 DIA WB PC SI	BY580P
910505102890	BY580P 170S/840 DIA HE WB PC SI	BY580P
910505102894	BY580P 170S/840 DIA WB GC SI ELP3	BY580P
910505102896	BY580P 170S/840 DIA HE WB GC SI ELP3	BY580P
910505102898	BY580P 130S/840 DIA MB GC SI	BY580P
910505102899	BY580P 170S/840 DIA MB GC SI	BY580P
910505102903	BY580P 130S/840 DIA HE MB GC SI	BY580P
910505102904	BY580P 170S/840 DIA HE MB GC SI	BY580P
910505102914	BY580P 170S/840 DIA NB GC SI	BY580P
910505102916	BY580P 170S/840 DIA HE NB GC SI	BY580P
910505102918	BY580P 170S/840 DIA XNB GC SI	BY580P
910505102920	BY580P 170S/840 DIA HE XNB GC SI	BY580P
910505102922	BY580P 170S/840 DIA HRO GC SI	BY580P
910505102924	BY580P 170S/840 DIA HE HRO GC SI	BY580P
910505102926	BY580P 170S/865 DIA WB GC SI	BY580P
910505102928	BY580P 170S/865 DIA HE WB GC SI	BY580P
910505102930	BY580P 170S/830 DIA WB GC SI	BY580P
910505102932	BY580P 170S/830 DIA HE WB GC SI	BY580P
910505102934	BY580P 170S/940 DIA WB GC SI	BY580P

Order Code	Full Product Name	Product family code
910505104558	BY580X 170S/840 SIA WB GC SI IA9	BY580X
910505104560	BY580X 170S/840 SIA HE WB GC SI ELP3 IA9	BY580X
910505102910	BY580P 170S/840 DIA ASYM GC SI MBW	BY580P
910505102912	BY580P 170S/840 DIA HE ASYM GC SI MBW	BY580P
910505102889	BY581P 250S/840 DIA WB GC SI BR	BY581P
910505102893	BY581P 250S/840 DIA HE WB GC SI BR	BY581P
910505102907	BY581P 250S/840 DIA ASYM GC SI BR	BY581P
910505102909	BY581P 250S/840 DIA HE ASYM GC SI BR	BY581P
910505102911	BY581P 250S/840 DIA ASYM GC SI MBW	BY581P
910505102913	BY581P 250S/840 DIA HE ASYM GC SI MBW	BY581P
910505102938	BY581P 350S/840 DIA HE WB GC SI BR XT 1m	BY581P
910505104551	BY581P 250S/840 DIA HE WB GC SI MSP BR	BY581P
910505104559	BY581X 250S/840 SIA WB GC SI IA9	BY581X
910505104561	BY581X 250S/840 SIA HE WB GC SI ELP3 IA9	BY581X
910505104563	BY581P 250S/840 DIA HE WBGCSICHEMBR1mCW5	BY581P
910505102888	BY580P 170S/840 DIA WB GC SI BR	BY580P
910505102892	BY580P 170S/840 DIA HE WB GC SI BR	BY580P
910505102908	BY580P 170S/840 DIA HE ASYM GC SI BR	BY580P
910505104550	BY580P 170S/840 DIA HE WB GC SI MSP BR	BY580P
910505104562	BY580P 170S/840 DIA HE WBGCSICHEMBR1mCW5	BY580P
910505104564	BY580P 170S/840 DIA HEWBGCSICHEMMBW1mCW5	BY580P
910505102873	BY581P 250S/840 PSU WB GC SI	BY581P
910505102875	BY581P 250S/840 PSU HE WB GC SI	BY581P
910505102877	BY581P 200S/840 DIA UE WB GC SI	BY581P
910505102880	BY581P 250S/840 DIA WB GC SI	BY581P
910505102881	BY581P 350S/840 DIA WB GC SI	BY581P
910505102884	BY581P 250S/840 DIA HE WB GC SI	BY581P
910505102885	BY581P 350S/840 DIA HE WB GC SI	BY581P
910505102887	BY581P 250S/840 DIA WB PC SI	BY581P
910505102891	BY581P 250S/840 DIA HE WB PC SI	BY581P
910505102895	BY581P 250S/840 DIA WB GC SI ELD3	BY581P
910505102897	BY581P 250S/840 DIA HE WB GC SI ELD3	BY581P
910505102901	BY581P 250S/840 DIA MB GC SI	BY581P
910505102902	BY581P 350S/840 DIA MB GC SI	BY581P
910505102905	BY581P 250S/840 DIA HE MB GC SI	BY581P
910505102906	BY581P 350S/840 DIA HE MB GC SI	BY581P
910505102915	BY581P 250S/840 DIA NB GC SI	BY581P
910505102917	BY581P 250S/840 DIA HE NB GC SI	BY581P
910505102919	BY581P 250S/840 DIA XNB GC SI	BY581P
910505102921	BY581P 250S/840 DIA HE XNB GC SI	BY581P
910505102923	BY581P 250S/840 DIA HRO GC SI	BY581P
910505102925	BY581P 250S/840 DIA HE HRO GC SI	BY581P
910505102927	BY581P 250S/865 DIA WB GC SI	BY581P

Order Code	Full Product Name	Product family code
910505102929	BY581P 250S/865 DIA HE WB GC SI	BY581P
910505102931	BY581P 250S/830 DIA WB GC SI	BY581P
910505102933	BY581P 250S/830 DIA HE WB GC SI	BY581P
910505102935	BY581P 250S/940 DIA WB GC SI	BY581P
910505102936	BY581P 250S/840 DIA HE WB GC SI XT 1m	BY581P
910505102937	BY581P 350S/840 DIA HE WB GC SI XT 1m	BY581P

Order Code	Full Product Name	Product family code
910505104541	BY583P 250S/840 DIA HE WB GC SI 0.5m CW5	BY583P
910505102856	BY580X 130S/840 SIA WB GC SI H4	BY580X
910505102857	BY580X 170S/840 SIA WB GC SI H4	BY580X
910505102860	BY580X 130S/840 SIA HE WB GC SI H4	BY580X
910505102861	BY580X 170S/840 SIA HE WB GC SI H4	BY580X

Polar Wide Diagrams

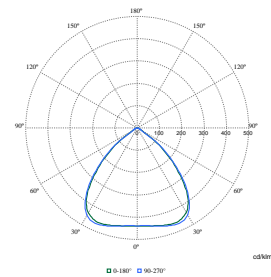
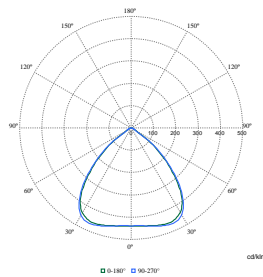
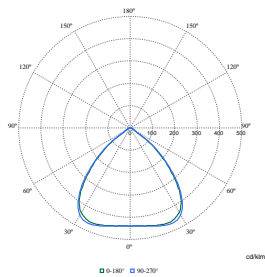

Polar Normal (separate) - BY580PI - 910505104541

Polar Normal (separate) - BY580PI - 910505102872

Polar Normal (separate) - BY580PI - 910505102863

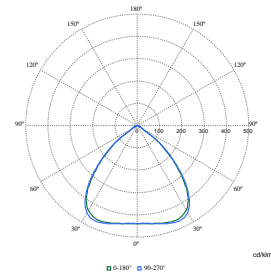
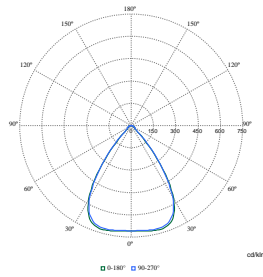
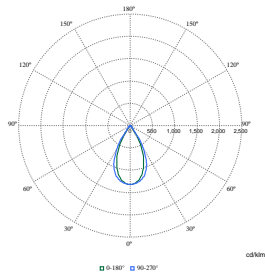

Polar Normal (separate) - BY580PI - 910505102914

Polar Normal (separate) - BY580PI - 910505102899

Polar Normal (separate) - BY580PI - 910505102869

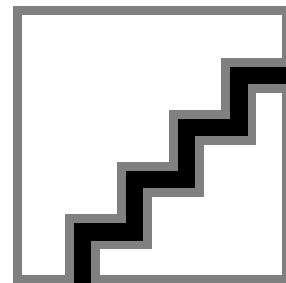
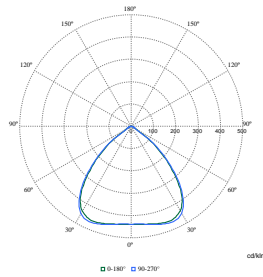
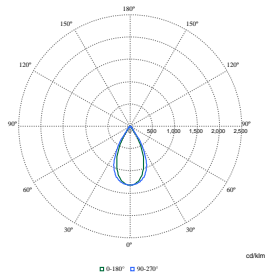

Polar Normal (separate) - BY580PI - 910505102915

Polar Normal (separate) - BY580PI - 910505102865

Polar Normal (separate) - BY580PI - 910505102895

Polar Wide Diagrams

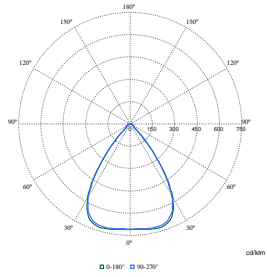

Polar Normal (separate) - BY580PI - 910505102898

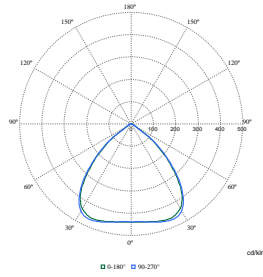

Polar Normal (separate) - BY580PI - 910505102856

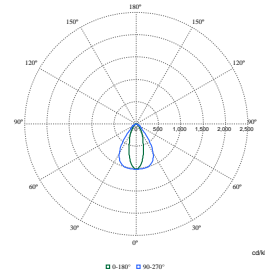

Polar Normal (separate) - BY580PI - 910505102924

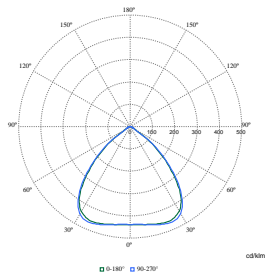

Polar Normal (separate) - BY580PI - 910505102881

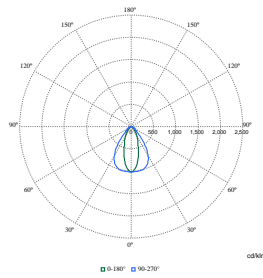

Polar Normal (separate) - BY580PI - 910505102925

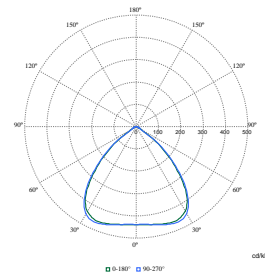

Polar Normal (separate) - BY580PI - 910505102857

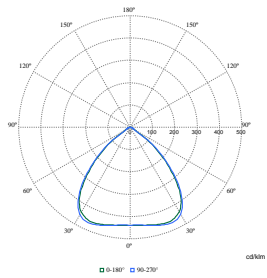

Polar Normal (separate) - BY580PI - 910505102933

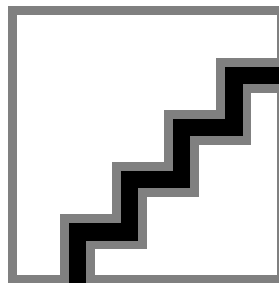

Polar Normal (separate) - BY580PI - 910505102873

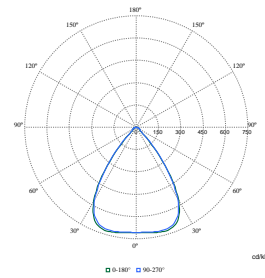

Polar Normal (separate) - BY580PI - 910505102902

Polar Wide Diagrams

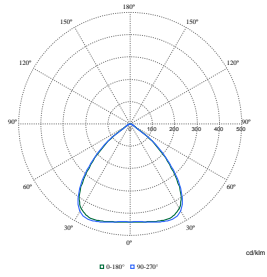

Polar Normal (separate) - BY580PI - 910505102884

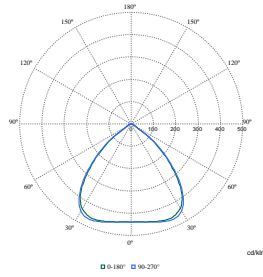

Polar Normal (separate) - BY580PI - 910505102874

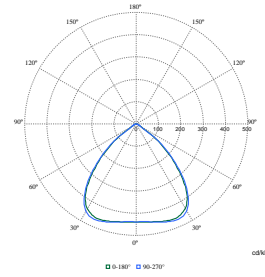

Polar Normal (separate) - BY580PI - 910505102896

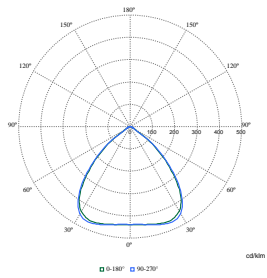

Polar Normal (separate) - BY580PI - 910505102875

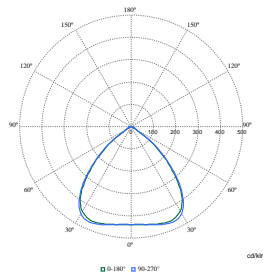

Polar Normal (separate) - BY580PI - 910505102868

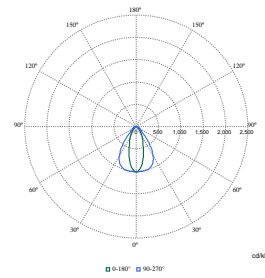

Polar Normal (separate) - BY580PI - 910505102923

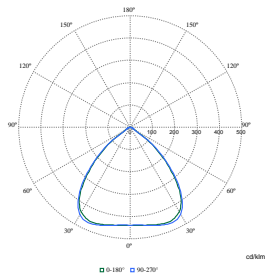

Polar Normal (separate) - BY580PI - 910505102858

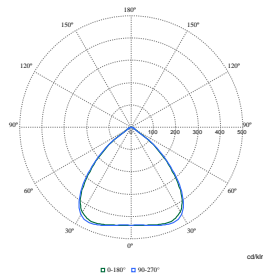

Polar Normal (separate) - BY580PI - 910505102871

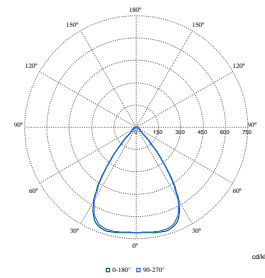

Polar Normal (separate) - BY580PI - 910505102901

Polar Wide Diagrams

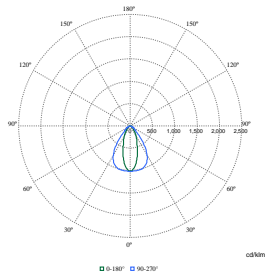

Polar Normal (separate) - BY580PI - 910505102922

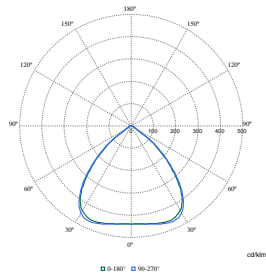

Polar Normal (separate) - BY580PI - 910505102862

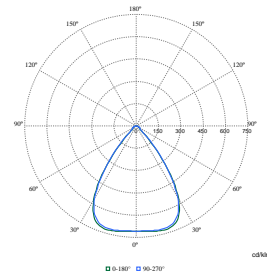

Polar Normal (separate) - BY580PI - 910505102906

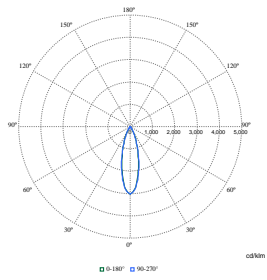

Polar Normal (separate) - BY580PI - 910505102921

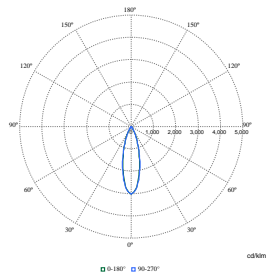

Polar Normal (separate) - BY580PI - 910505102920

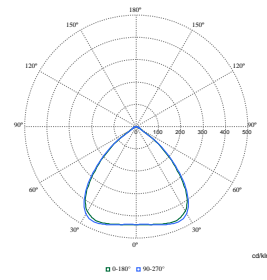

Polar Normal (separate) - BY580PI - 910505102932

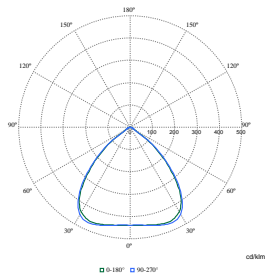

Polar Normal (separate) - BY580PI - 910505102864

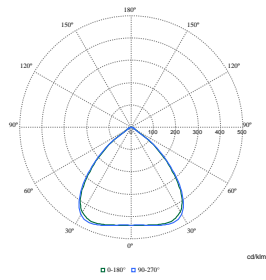

Polar Normal (separate) - BY580PI - 910505102934

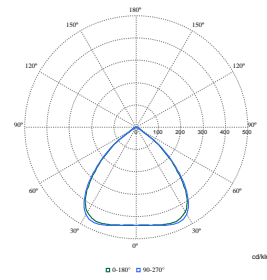

Polar Normal (separate) - BY580PI - 910505102878

Polar Wide Diagrams

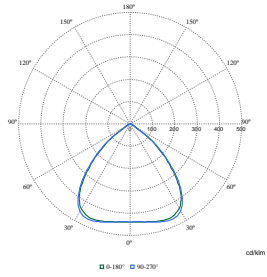

Polar Normal (separate) - BY580PI - 910505102866

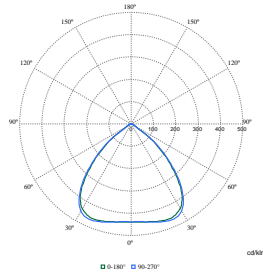

Polar Normal (separate) - BY580PI - 910505102885

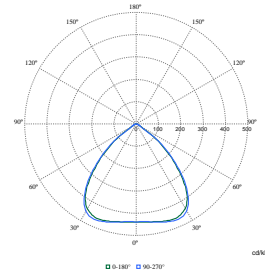

Polar Normal (separate) - BY580PI - 910505102883

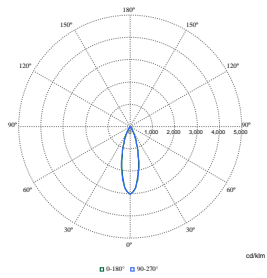

Polar Normal (separate) - BY580PI - 910505102918

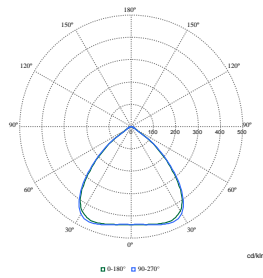

Polar Normal (separate) - BY580PI - 910505102882

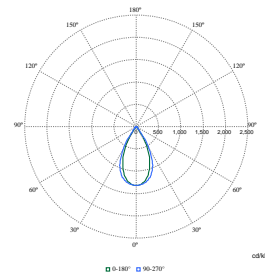

Polar Normal (separate) - BY580PI - 910505102916

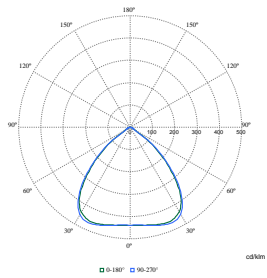

Polar Normal (separate) - BY580PI - 910505102926

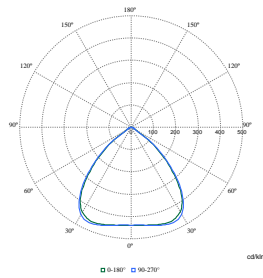

Polar Normal (separate) - BY580PI - 910505102928

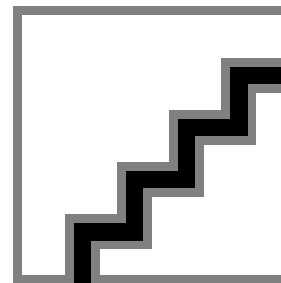

Polar Normal (separate) - BY580PI - 910505102935

Polar Wide Diagrams

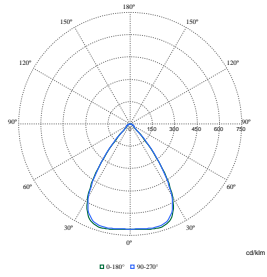

Polar Normal (separate) - BY580PI - 910505102903

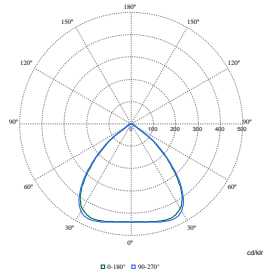

Polar Normal (separate) - BY580PI - 910505102891

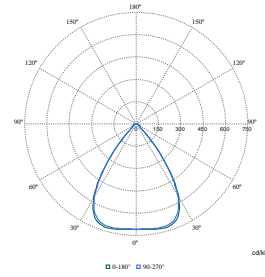

Polar Normal (separate) - BY580PI - 910505102904

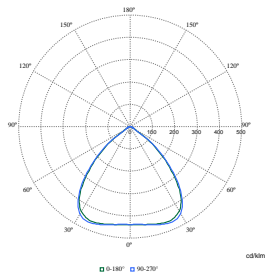

Polar Normal (separate) - BY580PI - 910505102886

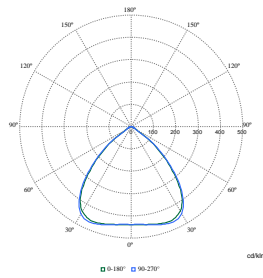

Polar Normal (separate) - BY580PI - 910505102867

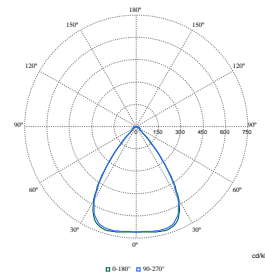

Polar Normal (separate) - BY580PI - 910505102905

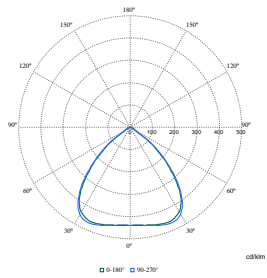

Polar Normal (separate) - BY580PI - 910505102890

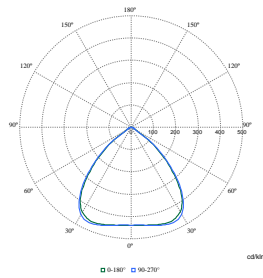

Polar Normal (separate) - BY580PI - 910505102894

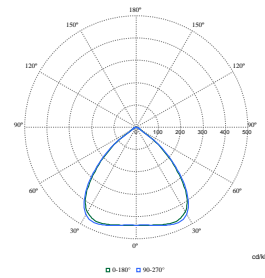

Polar Normal (separate) - BY580PI - 910505102930

Polar Wide Diagrams

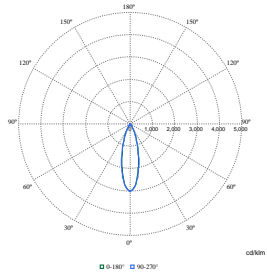

Polar Normal (separate) - BY580PI - 910505102919

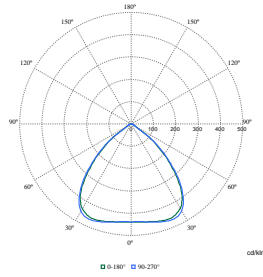

Polar Normal (separate) - BY580PI - 910505102879

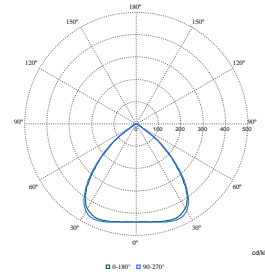

Polar Normal (separate) - BY580PI - 910505102870

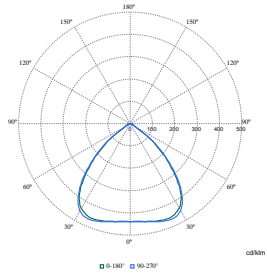

Polar Normal (separate) - BY580PI - 910505102887

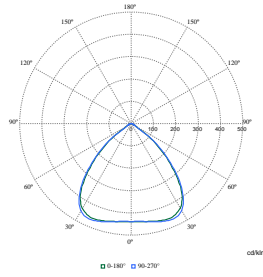

Polar Normal (separate) - BY580PI - 910505102859

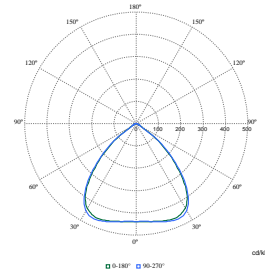

Polar Normal (separate) - BY580PI - 910505102892

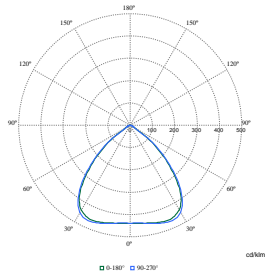

Polar Normal (separate) - BY580PI - 910505102893

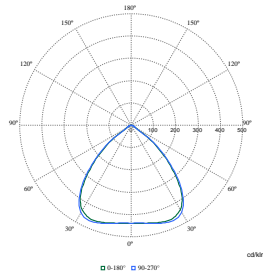

Polar Normal (separate) - BY580PI - 910505102860

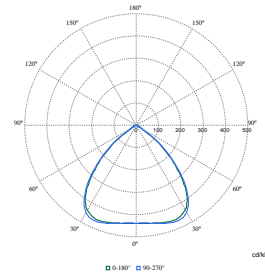

Polar Normal (separate) - BY580PI - 910505102929

Polar Wide Diagrams

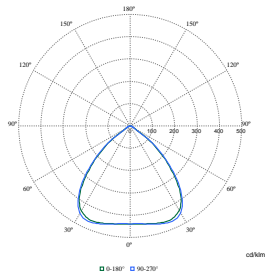

Polar Normal (separate) - BY580PI - 910505102931

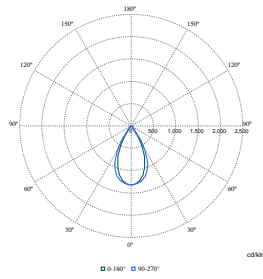

Polar Normal (separate) - BY580PI - 910505102917

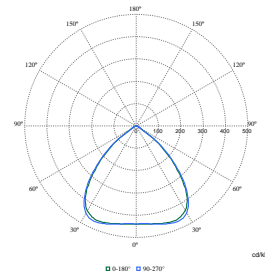

Polar Normal (separate) - BY580PI - 910505102877

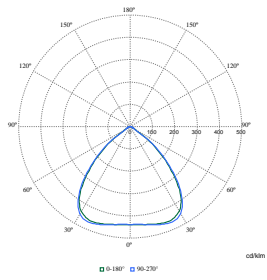

Polar Normal (separate) - BY580PI - 910505102889

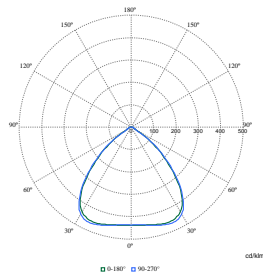

Polar Normal (separate) - BY580PI - 910505102927

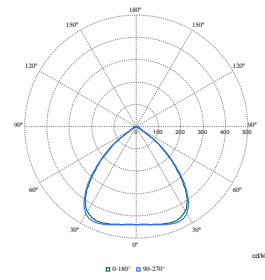

Polar Normal (separate) - BY580PI - 910505102861

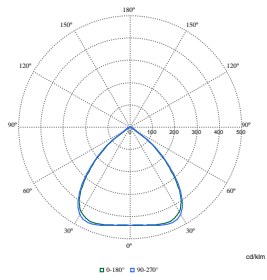

Polar Normal (separate) - BY580PI - 910505102888

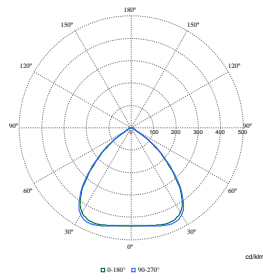

Polar Normal (separate) - BY580PI - 910505102880

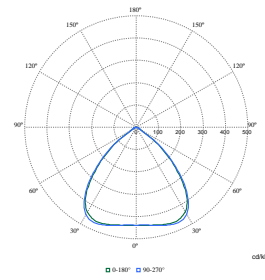

Polar Normal (separate) - BY580PI - 910505102897

Polar Wide Diagrams

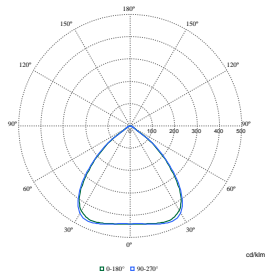

Polar Normal (separate) - BY580PI - 910505102876

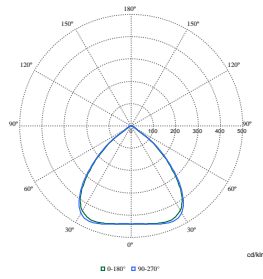

Polar Normal (separate) - BY580PI - 910505102938

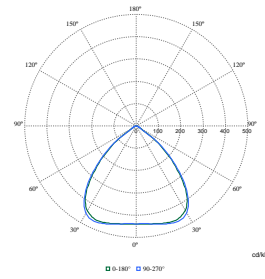

Polar Normal (separate) - BY580PI - 910505102936

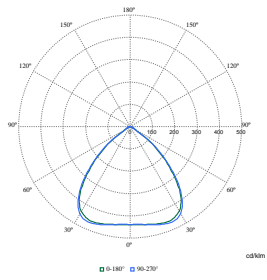

Polar Normal (separate) - BY580PI - 910505102937

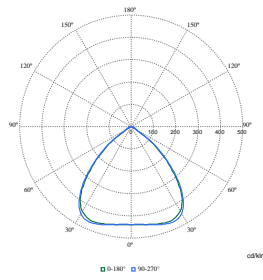

Polar Normal (separate) - BY580PI - 910505104550

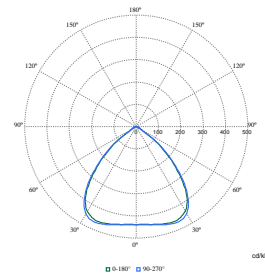

Polar Normal (separate) - BY580PI - 910505104551

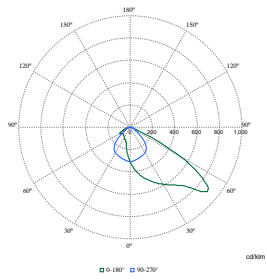

Polar Normal (separate) - BY580PI - 910505102907

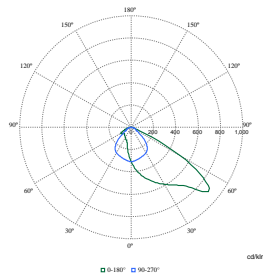

Polar Normal (separate) - BY580PI - 910505102913

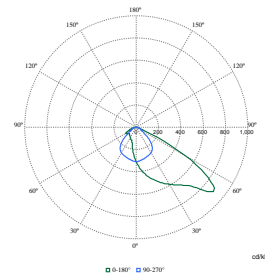

Polar Normal (separate) - BY580PI - 910505102912

Polar Wide Diagrams

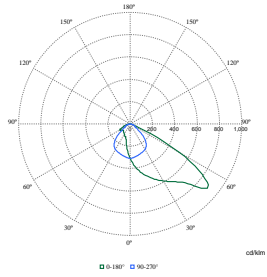

Polar Normal (separate) - BY580PI - 910505102909

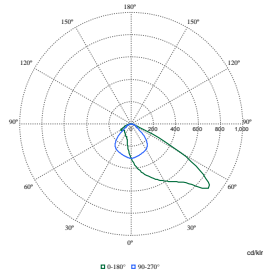

Polar Normal (separate) - BY580PI - 910505102908

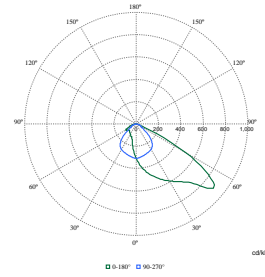

Polar Normal (separate) - BY580PI - 910505102910

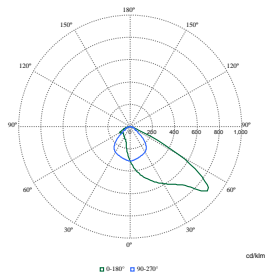

Polar Normal (separate) - BY580PI - 910505102911

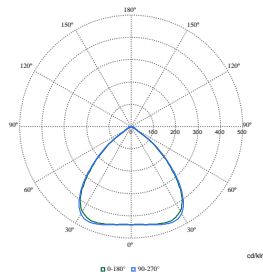

Polar Normal (separate) - BY580PI - 910505104563

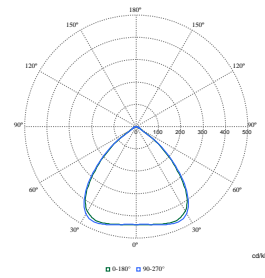

Polar Normal (separate) - BY580PI - 910505104564

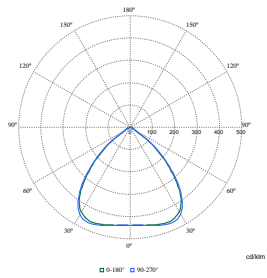

Polar Normal (separate) - BY580PI - 910505104565

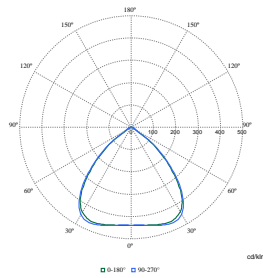

Polar Normal (separate) - BY580PI - 910505104562

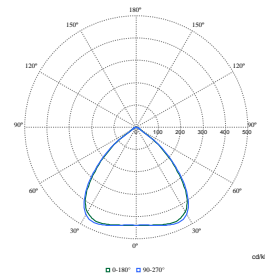

Polar Normal (separate) - BY580PI - 910505104561

## Polar Wide Diagrams

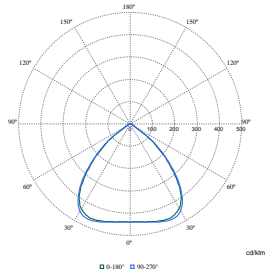

**Polar Normal (separate) - BY580PI -  
910505104558**

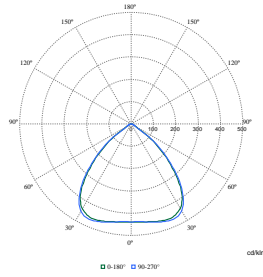

**Polar Normal (separate) - BY580PI -  
910505104559**

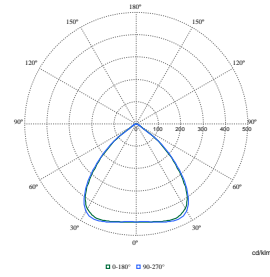

**Polar Normal (separate) - BY580PI -  
910505104560**

