

READ AND UNDERSTAND THESE INSTRUCTIONS BEFORE INSTALLING FIXTURE

This fixture is intended for installation in accordance with the National Electrical Code and local regulations. To assure full compliance with local codes and regulations, check with your local electrical inspector before installation. To prevent electrical shock, turn off electricity at fuse box before proceeding.

Retain these instructions for maintenance reference.

INSTRUCTION SHEET NO.

IS:2002

INSTALLATION PROCEDURE FOR FRAME-IN KIT (NEW CONSTRUCTION ONLY)

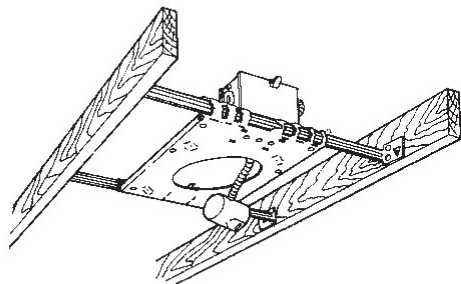

FIG. A
1. FRAME-IN

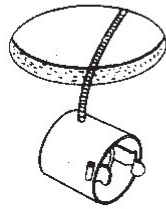

FIG. B
2. CLOSE-IN

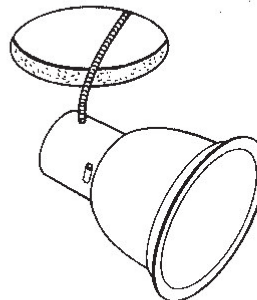

FIG. C
3. SNAP-ON

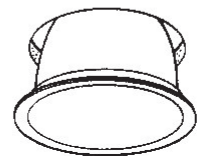

FIG. D
4. PUSH-UP

WARNING—(RISK OF FIRE) DO NOT INSTALL INSULATION WITHIN 3 INCHES OF FIXTURE SIDES OR WIRING COMPARTMENT, NOR ABOVE FIXTURE IN SUCH A MANNER TO ENTRAP HEAT.

1. FRAME—IN (Fig. A)

Fasten MOUNTING FRAME to wood joist. Line up bottom edge of ADJUSTABLE MOUNTING BAR with bottom of wood joist (Fig. E). Wire to supply leads. White fixture lead to neutral supply lead. Black fixture lead to hot (120V.) supply lead. Bare fixture wire to supply ground. Use wirenuts (local hardware items). Place all electrical connections in the J-BOX. Attach J-BOX COVER onto J-BOX. (Use built-in Cable Clamp in J-Box. For non metallic sheathed cable (Romex).

NOTE: ADJUSTABLE MOUNTING BARS can be extended for 24" mounting. (For suspended ceiling, make certain that the bottom of MOUNTING FRAME is no higher than 1" above ceiling line (Fig. F).

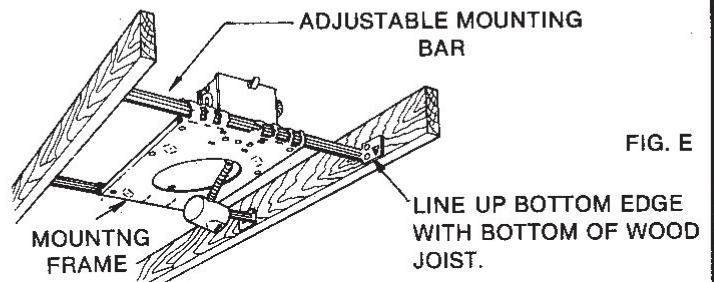
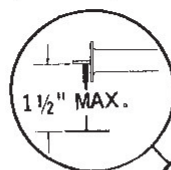

FIG. E

2. CLOSE—IN (Fig. B)

Install plasterboard or other dry type ceiling, as required. Hole in board can be cut either on the ground or after the board is nailed to the ceiling, using MOUNTING FRAME opening as a cutting guide. (Make sure ROTO-CLIPS are rotated out of hole area to be cut.)

NOTE: For wet plaster ceiling, use Plaster Ring Accessory No. 1959 (order separately).



Position NAILING TABS of ADJUSTABLE MOUNTING BAR on top of T-BAR for proper spacing to finished ceiling. T-BAR ANCHOR CLIPS ACCESSORY NO. 1956 (order separately) can be used for quick mounting

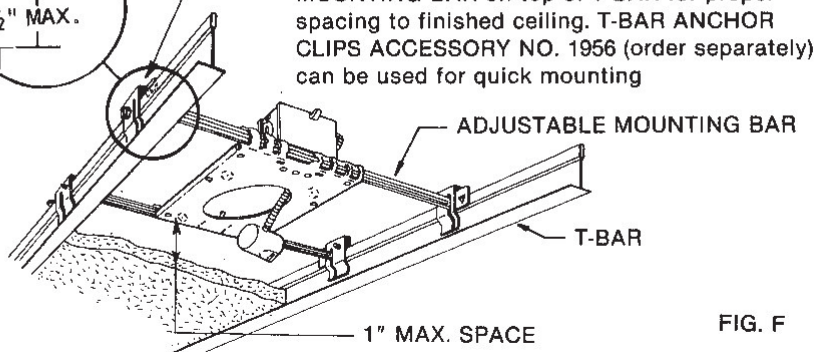

FIG. F

3. SNAP-IN (Fig. C).

SEE SEPARATE REFLECTOR TRIM INSTRUCTION SHEETS.

4. PUSH-UP (Fig. D).

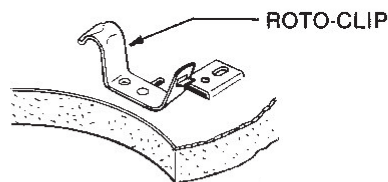

FIG. G

WARNING: USE ONLY REFLECTOR TRIMS PROVIDED BY LIGHTOLIER INC. USE OF OTHER MANUFACTURERS' REFLECTOR TRIMS VOIDS THE UNDERWRITERS LABORATORIES LISTING AND COULD CONSTITUTE A FIRE HAZARD.

**PHILIPS
LIGHTOLIER**

Philips Lighting North America Corporation
200 Franklin Square Drive
Somerset, NJ 08873, USA
Phone: 855-486-2216

Philips Lighting Canada Ltd.
281 Hillmount Road
Markham ON, Canada L6C 2S3
Phone: 800-668-9008