

PHILIPS

Fortimo

LED system

SLM

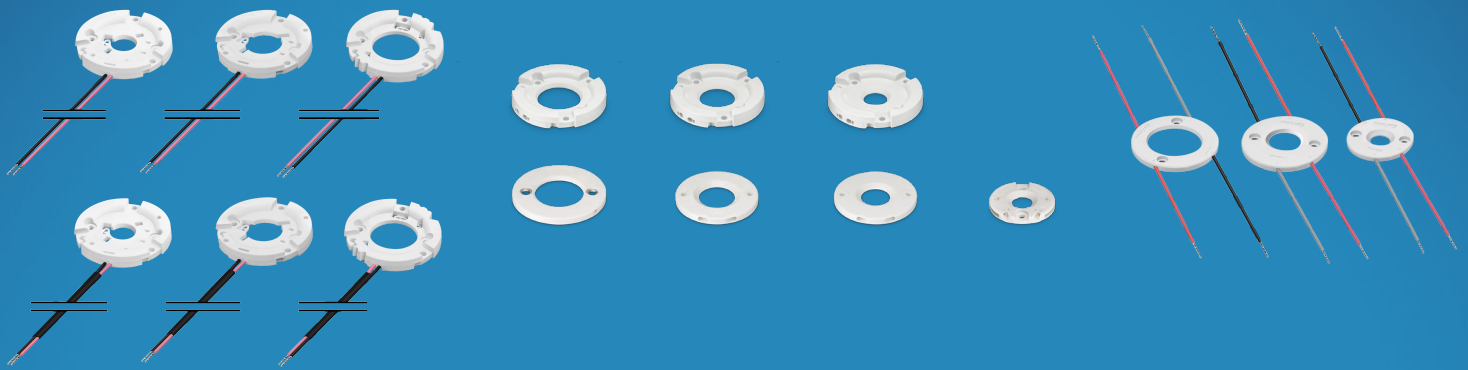
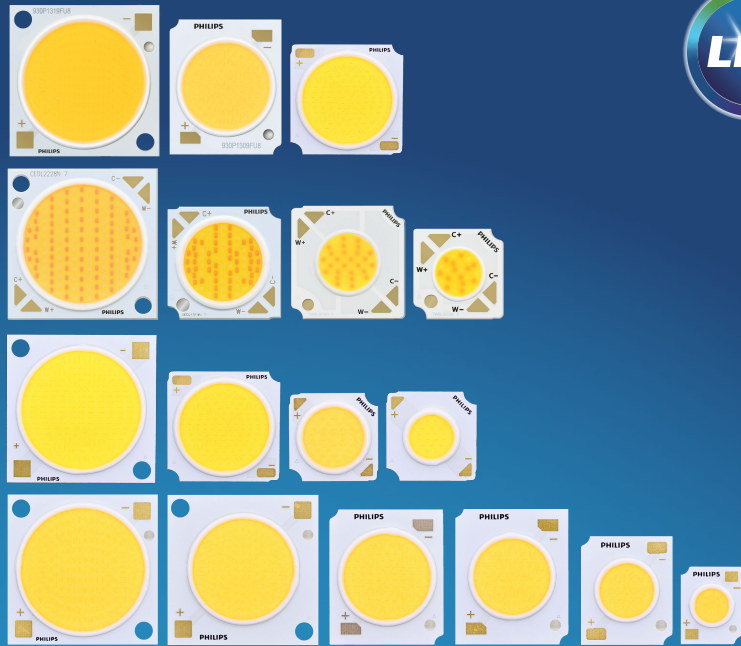

Datasheet

New levels of **brightness** and **saturation** in retail

August 2025

Contents

Introduction to this guide	4	Mechanical design-in	20
Information and support	4	Fortimo LED SLM module dimensions	20
Determine which documents contain what information	4	Recommended torque	20
		Wires for SLM Poke-in versions	20
		Using the CoB without a holder	20
		Recommended soldering process	21
		Recommendations	22
Warnings and instructions	5	Thermal design-in	23
When using a driver, intended for these modules	5	Optimum performance	23
Safety warnings and installation instructions	5	Test requirements	23
Design-in phase	5	Critical measurement points	23
Manufacturing phase	5	Tc-nominal and Tc-max	25
Installation and service for luminaires incorporating the Fortimo LED SLM System	6	How to measure the critical temperature point Tc	26
Signify Design-in support	6	Thermal interface material	26
System disposal	6	Electrical and thermal analogy	27
		Thermal model	27
		Thermal design of a heat sink	28
		Active and passive cooling	29
		Complementary thermal solution partners	30
Introduction to the SLM system	7	Electrical design-in and flexibility	31
Application Information	7	Connection to the mains supply	31
Module types	7	Isolated LED Drivers	31
Choosing the Correct Fortimo LED SLM module	9	Tune the luminaire's flux (lm) and efficacy (lm/W)	31
Naming of the Fortimo LED spotlight modules	9	Effect of Choosing a different current value	31
CoB	9	Set the output current via Rset	32
Holder	10	Programming the output current	34
Assembling your Fortimo LED SLM module	11	Xitanium Indoor Spot and Downlight LED drivers	34
Can the Fortimo LED SLM module be used in outdoor applications?	12	Compatible Drivers with SLM	34
In this design-in guide	12		
Holders for Fortimo SLM	13	Human Centric Lighting solutions	35
Impact of Choice of Holder on Flux Output	15	Cyan Enhanced Spectra	35
Xitanium LED drivers for Fortimo LED SLM	16	Connected Lighting Systems – MasterConnect	35
Optical design-in	17	Reliability	38
Light distribution	17	Lumen maintenance	38
Reflector design limits	17		
Ray sets	18		
Color consistency	18		
Color targets	18		
Spectral light distribution	19		
Complementary partners for Secondary Optics	19		
Starting characteristics	19		

Controllability	39
Dimming the Philips Fortimo LED SLM system	39
Complementary partners	40
Compliance and approval	41
Compliance and approbation	41
IP rating, humidity and condensation	41
Electrostatic discharge (ESD)	41
Switching cycles versus case temperature	41
Some facts on blue light	42
Environmental compliance	42
CrispWhite Technology	42
Chemical Compatibility	43
Cautions	44
Contact details	45
Signify	45
Design-in Support Terms & Conditions for EMEA	46

Introduction to this guide

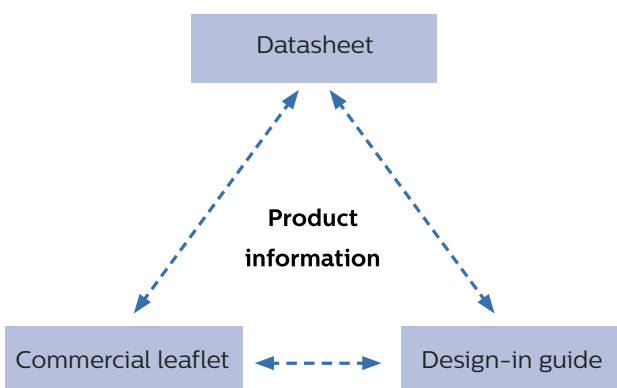
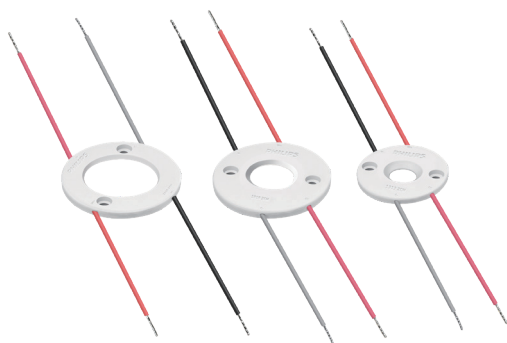
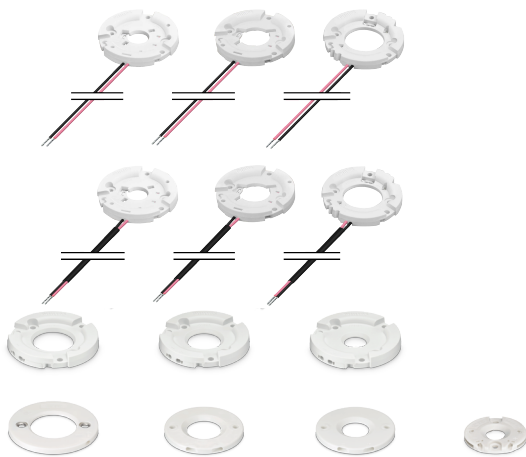
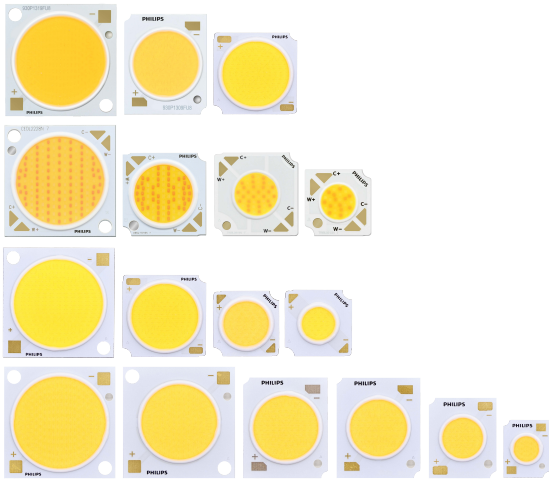

Thank you for choosing the Philips Fortimo LED SLM. In this guide you will find the information required to design this module into a luminaire.

Information and support

If you require any further information or support please consult your local Signify office or visit our website: www.Philips.com/Technology

Determine which documents contain what information

In order to provide information in the best possible way, Signify's philosophy on product documentation is the following.

- **Commercial leaflet** contains product family information & system combinations (compatible Philips drivers and Rsets)
- **Datasheet** contains the module (CoB and holder) specification
- **Design-In Guide** describes how to design-in the products

All these documents can be found on the download page of the OEM website www.Philips.com/Technology.

If you require any further information or support please consult your local Signify office.

Warnings and instructions

When using a driver, intended for these modules



Warnings:

- Avoid touching the light emitting surface!

Safety warnings and installation instructions

To be taken into account during design-in and manufacturing.

Design-in phase

- Do not apply mains power to the module (Philips Fortimo LED SLM CoB and holder) directly.
- Connect the modules and drivers before switching on mains.
- Provide adequate environmental protection
- Due to the Tcase nominal temperature of the Fortimo LED SLM of 85 °C, it is important to take into account the maximum touchable metal surface temperatures of the luminaire. With such a high Tc temperature the maximum temperature for touch safety can easily be exceeded.
- Avoid contamination (direct or indirect) from any incompatible chemicals reacting with the silicone. A list of incompatible chemicals is provided in the chapter for Compliance and Approval.

Manufacturing phase

- Do not use products in case the phosphor on the CoB is discolored/ scratched or if the holder is broken.
- Do not drop the LED SLM or damage in any way.
- Connect the modules and drivers before switching on mains.
- Avoid contamination (direct or indirect) from any incompatible chemicals reacting with the silicone. A list of incompatible chemicals is provided in the chapter for Compliance and Approval.

Installation and service for luminaires incorporating the Fortimo LED SLM System

- Do not service the luminaire when the mains voltage is connected; this includes connecting or disconnecting the LED SLM holder from the driver.

Signify Design-in support

Is available; please contact your Signify sales representative.

System disposal

Please inform yourself about the local waste disposal, separation and collection system for electrical and electronic products and packaging. Please act according to your local rules and do not dispose of your packaging and old product with your normal household waste. The correct disposal of your product will help prevent potential negative consequences for the environment and human health.

Introduction to the SLM system

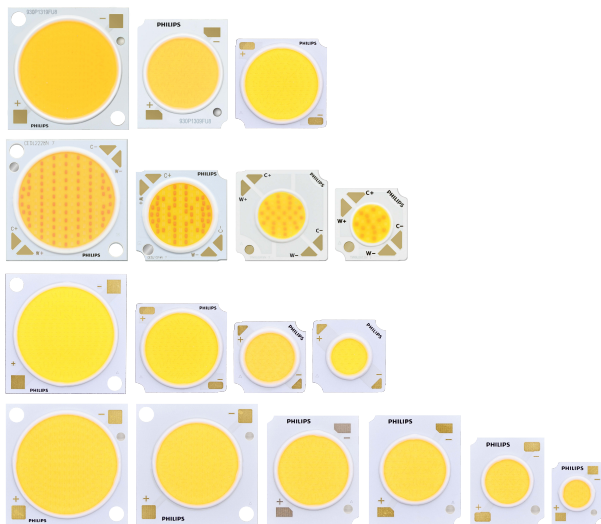

CoBs

Application Information

The Philips Fortimo LED Spotlight Module (SLM) is a high-performance, compact, and cost-effective series of products for general and accent lighting. This product offers a long-lifetime and energy efficient lighting solution for retail, hospitality and general down-lighting applications. It is consistent with other Fortimo families of modules, delivering a high quality of light and peace of mind.

Module types

The SLM module comprises of a range of CoBs that can be used without a holder, or can be paired with the following holders:

- A standard holder with fitted pre tinned cables (with or without a sleeve)
- A poke-in holder

An overview is provided in the Commercial Leaflet in the download section on www.Philips.com/Technology.

The user can choose to operate any of these modules at different currents to obtain a required lumen output.

With the Fortimo SLM, the user has the flexibility to choose amongst a wide range of CoBs and pair it with any of the available holders. Each CoB can be tuned as per need in order to achieve a high lm/W or a high lm/€. This provides the user with a full portfolio comprising of a wide range of products.

Note:

The system warranty is valid only if the complete system (CoB + driver) is used. The OEM is free to choose a holder provided (a complete list can be found in the commercial leaflet or in the datasheet of the holders, both of which can be found at www.Philips.com/technology), or to use the CoB without a holder and soldering wires on to it.



Holders

Examples of CoB identification marks



A. Marker for Fortimo SLM C 930 1208 L15 2024 G7
 B. Marker for Fortimo SLM C 930 PW 1208 L15 2024 G8

Identifying a CoB

On ordering a Fortimo SLM CoB, the customer will receive a box stating the CoB type. Apart from this, each CoB has a printed label on it describing the color and CoB type to enable easy identification. The following is a description of the identification on the CoB:

Type marking from Fortimo SLMs G7(N)/G8(N) ABBCxxyyDEF

A CRI/10	BB CCT/100	C Product Line	xyy CoB config.	D Portfolio	E * Specialty	F Gen
7 = CRI70	22 = 2200K	Space/Blank = Standard	1201	F = Fortimo	Space/Blank = Standard	1
8 = CRI80	25 = 2500K	A = Premium Ambiance	1202	N = Fortimo new form factor	H = High Density	...
9 = CRI90	27 = 2700K	B = Food Warm White for Bakery	1203		X = High Efficacy CRI90	7
	30 = 3000K	C = Crisp White	1204		Y = High Efficacy CRI90	8
	35 = 3500K	F = Seafood	1205		plus	...
	40 = 4000K	L = Premium Color	1206		U = Ultra High Efficacy	
	50 = 5000K	P = Premium White	1208		...	
	57 = 5700K	R = Food Premium Red	1210			
	65 = 6500K	S = PS	1211			
		V = Food Vegetable and Fruit	1212			
		W = Food Warm White	1216			
		...	1309			
			1319			
			1812			
			1818			

Marker from Fortimo SLM CED and SLM TW AAALxx yyDEF

AAA Family	Lxx LES size	yy Outline size	D Portfolio	E color	F Gen
CED=Cyan enhance dynamic	06	13	N= Fortimo new form factor	TW: Space=927/965	1
TW9=Tunable White	09	19		x=927/950	...
	13	28		CED: Space	7

In this guide you will find the specific information required to develop a luminaire based on Philips Fortimo LED SLM module. Product specific data can be found in the associated datasheet on www.Philips.com/Technology.



Fortimo LED SLM module

Choosing the Correct Fortimo LED SLM module

The Fortimo SLM module is offered in a wide range of options. Please refer to the appropriate datasheets for details about each module. This module can then be used at a number of different operating points to suit your needs.

Naming of the Fortimo LED spotlight modules

The names of the modules are defined as shown in the example below:

CoB

Fortimo SLM C (z)(cc) (d) (m) L(ee) (s) G(i)(a)

Fortimo: Our brand name for high quality, efficient, smart, future proof, and reliable LED lighting

SLM: Spot Light Module

C: No special meaning (originally: CoB)

z: CRI divided by 10 (may be blank when d = "CED", or one digit, may be "7", "8", or "9");

cc: CCT divided by 100 (two digits or six characters (or blank when d = "CED"), may be a value between 22 and 65);

d: Flavour of light (two or three characters, may be "Px (x could be W, C, S, A or any character)" or "CW" or "FPR" or "FWW" or "FLS" or "FVF" or "FFS" or "FIS" or "CED" or "TW" or blank);

Blank = Standard

PW = Premium White

PC = Premium Color

CW = Crisp White

FPR = Food Premium Red

FWW= Food Warm White

FLS = Food Live Seafood

FIS = Food Iced Seafood

FVF= Food Vegetable and Fruit

FFS = Food Fresh Seafood

m: Die matrix (four digits, example 1216; chip configuration = 12 chips in series per string & 16 strings in parallels, (or blank when d = "CED"));
ee: Diameter of the Light Emitting Surface (LES) in millimeter (one or two digits, example 23; LES dimensions = 23mm);
s: PCB size in mm (four digits, example 2828: CoB dimension = 28mm × 28mm);
i: Number of generation of CoB (one digit, may be "8");
a: Suffix for commercial purposes (optional).

Holder

FORTIMO SLM H YY 2024 Lxxx G1

Fortimo: Our brand name for high quality, efficient, smart, future proof, and reliable LED lighting
SLM: Spot Light Module
H: Holder
YY: Holder version
 blank = standard version
 DL = Down Light version
 PI = Poke-In version
 ZP = Zhaga Poke-in version
 2CH = Two-channel
2024: Dimensions of the CoB-cavity in the holder, to be matched with the diomensions of the CoB
Lxxx: For Holders with wire: xxx mm wire length
G: Generation

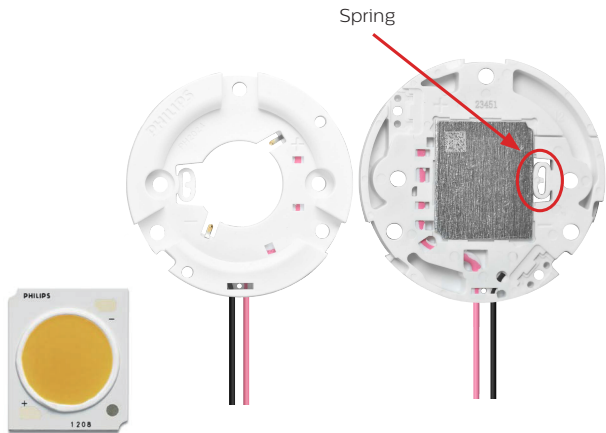

Assembling your Fortimo LED SLM module

The Fortimo SLM module is delivered to you as a combination of the CoB and holder. To assemble the two, please ensure that the + and – sign on the CoB are aligned with that on the holder. The CoB must be clicked into the slot by pushing back onto the spring. The pictures on the left explain this process step by step.

Note:

For the poke-in (PI) holder for L19, a provision is made to incorporate CoBs of various thickness. Two stainless steel clamps are integrated within the holder and are activated by screwing down into the heat sink. Depending on the type of CoB, there may be no contact with the heat sink once inserted into the holder. When clamps are screwed down, the CoB will have a good thermal down force. It is a metal, mechanically closed system so there will be no plastic creepage.

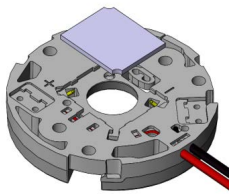

Step 1: Align the + and - of the CoB and holder

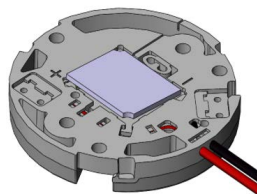

Step 2: Place the CoB against the spring at an angle

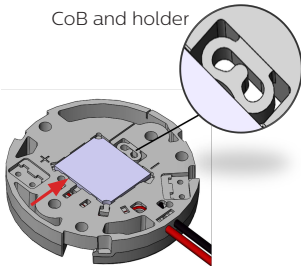

Step 3: Compress the spring with the CoB

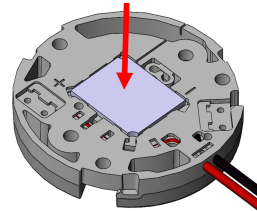

Step 4: Click the CoB down into the holder

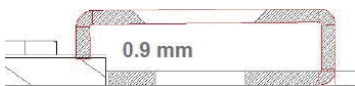

Can the Fortimo LED SLM module be used in outdoor applications?

Yes, the Fortimo SLM products can be used in outdoor applications. However, please note that neither the Fortimo LED module nor the Indoor Point LED driver has an IP classification. If these products are used in luminaires for outdoor applications, it is up to the OEM to ensure proper protection of the luminaire. Please consult us if you wish to deviate from the design rules described in this guide.

In this design-in guide

In this design-in guide you will find all necessary guidelines to configure the Fortimo LED SLM module to exactly fit your needs.

The range consists of a wide selection of of Chip-on-Board (CoB) products:

- Standard versions in various lumen packages and colours; on the black body line.
- Premium White in various lumen packages and colours; below the black body line providing an improved white perception.
- SLM CrispWhite: An optimized spectrum for retail, providing intense whites and rich colours.
- SLM Food Warm White: A specific spectrum for enhancing the appearance of fresh food.
- SLM Food Premium Red: A specific spectrum for enhancing the appearance of fresh meat. The initial purpose of this product is for retail lighting applications, more specifically for e.g. food, furniture and leather. The product is not intended for use in other applications.

Each of these CoBs can be paired with any of our available holders (standard: with fitted pre-tinned cables, downlight: with fitted pre-tinned cables with a sleeve and poke in) to give full flexibility and freedom to the customer.

The pre-tinned cables come in a length of 60 cm. The OEM can cut this to the length required. However, in the case of downlight versions where the cables are in a sleeve, this is not advised.

Note:

It is advised to avoid sharp corners in your luminaire where the wires need to pass. This is done to avoid damage to the insulation of wires.

On top of this broad range in standard settings and building blocks, the Fortimo LED SLM portfolio provides the luminaire manufacturer with a high level of flexibility to obtain a specific luminaire performance, while using the same components. In combination with our Xitanium LED drivers, the user has the possibility to drive their module at different currents in order to achieve a high lm/W or a high lm/€ at different lumen outputs.

 Holders for Fortimo SLM

The Fortimo SLM system can be supplied with a selection of CoBs and holders. In this section, we describe the differences in the holder types:

1. Holder with Pre-tinned Cables

Each CoB can be bought in combination with this holder. The length of the cable is by default 600mm, but the customer can cut it to the appropriate length if needed. There is a version with 280mm available as well.

2. Holder with Tin-dipped Cables, with a sleeve (60cm)

These holders are available if the Fortimo SLM module must be used in a downlight application.

It is not advised to cut the length of this cable.

Available in two length: 280mm and 600mm.

3. Poke-in holder

The absence of cables on the holder, allows for late stage configuration. Please note that this holder has a different height than the other two versions. Details of the dimensions are provided in the datasheets available at www.Philips.com/Technology.

4. Zhaga Poke-in holder

This holder comes without cables to allow the customer flexibility in production flow, like the poke-in holder. Otherwise, this holder is the same as the standard holder in dimensions and properties.

5. 2CH(two-channel) holder

This holder is especially designed for SLM Tunable white and CED module which with two separate strings of LEDs. It is with 60cm pre-tinned cables.

The compatibility information of SLM module and holder can be found in the datasheets of holder family. These documents can be downloaded via www.Philips.com/Technology.

For outdoor applications, we recommend that wires are soldered on instead of using a holder. A number of features can vary between all holders. It is important to read this guide in order to understand this. The table below shows a summary of differences.

Standard/downlight version	Poke-in version	Zhaga Poke-in version
Fitted with pre tinned cables (with/without a sleeve)	No cables attached	No cables attached
CoB clicked in by pushing against the spring	CoB clicked in by pushing against the spring for the holders catering to LES 9 – 15. The holder for LES 19 has a different mechanism. Two metal springs are provided. The holder can be pressed against the CoB to click it in.	CoB clicked in by pushing against the spring
ENEC+ certified	Not ENEC certified	ENEC+ certified
Zhaga compatible	Not Zhaga compatible except for the position of the screw holes.	Zhaga compatible
Height is higher than the poke-in version	Lower (dimensions available in datasheets)	Height same as the standard version
3 screw holes available, along with 2 Zhaga compatible screw holes	Only the Zhaga screwholes are available	Screw holes same as the standard version
Daisy chaining allowed for a voltage ≤ 150 V	Daisy chaining not allowed	Daisy chaining allowed for a voltage ≤ 200 V
Provision to feed through a thermo couple wire to use the T sense point	No such provision	Provision to feed through a thermo couple wire to use the T sense point
Late stage configuration not possible	Late stage configuration possible	Late stage configuration possible
Provision for easy reflector attachment	No provision for reflector attachment	Provision for easy reflector attachment

Impact of Choice of Holder on Flux Output

Depending on the CoB in question, the choice of holders can have an impact on the flux output. Please refer to the table below for more information.

CoB type	Flux Output				
	Bare CoB	Standard/Downlight Holder	Poke-in Holder	Zhaga Poke-in Holder	2CH Holder
1202	100.00%	99.20%			
1203	100.00%	98.30%	99.70%	99.30%	
1205	100.00%	98.60%	99.20%	99.50%	
1208	100.00%	98.50%	99.50%	99.10%	
1211	100.00%	98.70%	99.50%	98.80%	
1216	100.00%	98.90%			
TW1313					99.80%
TW1919					99.10%
CED1919					99.30%
CED2828					99.30%
Average:	100.00%	98.60%	99.30%	99.20%	

Note:

Please note that it is possible to use the Fortimo SLM CoBs without a holder. The wires can be soldered on.

Note:

In case the OEM needs to supply luminaires to North America, there may be differences in regulations. Please check with your sales representative or contact the Design-in team.

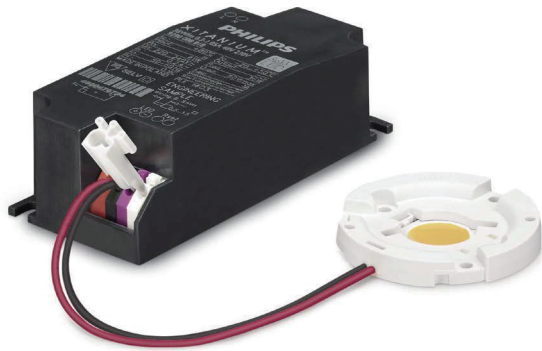

Fortimo LED SLM module

Xitanium LED drivers for Fortimo LED SLM

These highly efficient LED drivers are designed for the Fortimo LED modules. These are available as a built-in or independent driver, dimmable or with a fixed output.

Xitanium Wireless driver for Fortimo SLM Tunable white module

Xitanium Wireless FlexTune and Wiz driver is compatible to drive the Fortimo SLM Tunable White modules and CED module as well. The system can be configured via smart devices with MasterConnect and WiZ app as standalone or in a mesh network to realize smart control. The accessories are available.

More information about the Xitanium drivers for Fortimo LED SLM modules can be found in the Xitanium indoor down and spotlight driver design in guide and the Xitanium commercial leaflet. These documents can be downloaded via www.Philips.com/Technology.

The Xitanium driver datasheets can also be downloaded on this website. Full system overviews can be obtained using the Easy Design-in tool at www.easydesignintool.philips.com.

Optical design-in

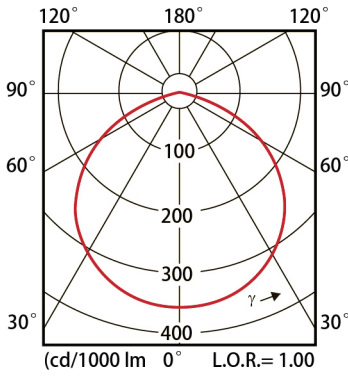

Light distribution diagram

Light distribution

Fortimo LED SLM generates a Lambertian beam shape (see light distribution diagram). The secondary optics design should not cover the exit aperture. The IES (or .ldt) files are available via the website www.Philips.com/Technology.

Reflector design limits

The graphs below give an indication of the relation between the diameter of the reflector exit aperture and the minimum beam angle (FWHM) or beam peak intensity that can be achieved with Fortimo LED SLM modules.

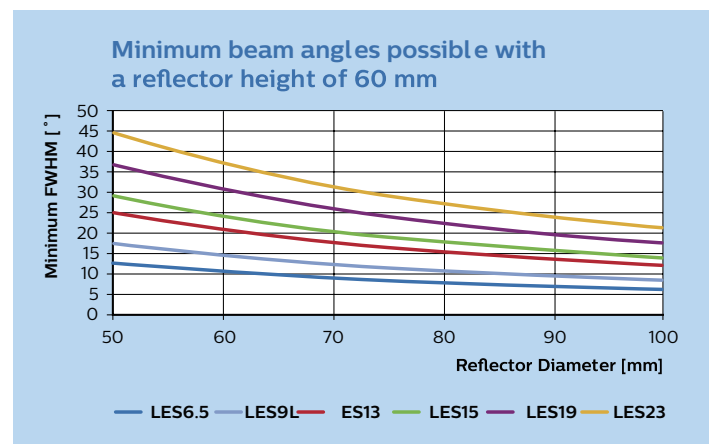
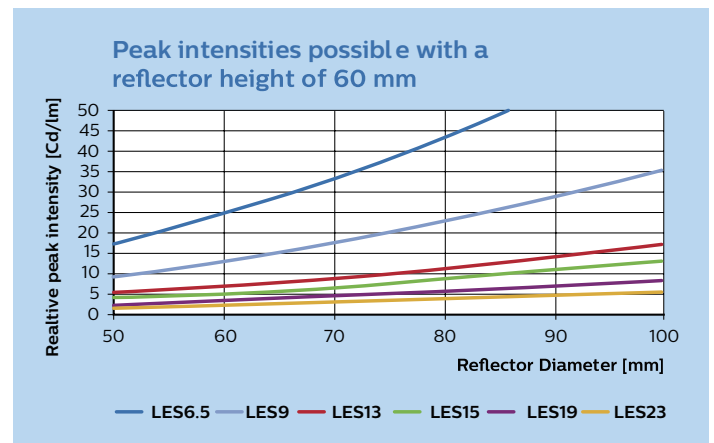

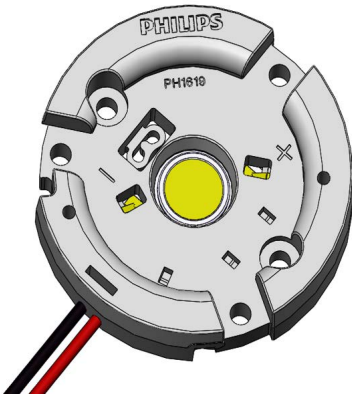

Rayset Origin

Ray sets

The following ray set files are available for customer use, and can be downloaded from www.Philips.com/Technology.

All ray set files are available containing 100,000, 500,000 and 5,000,000 rays.

Software	File extension
ASAP	.dis
Light Tools (ASCII)	.ray (zipped)
TracePro/Oslo (ASCII)	.dat (zipped)
Zemax	.dat

The origin of the ray sets is shown in the pictures on the left, and it coincides with the origin of the CAD file:

- X = 0 and Y = 0 at the center of the module.
- Z = 0 at the emitting surface (2 mm below the inner flat surface of the cover).

Note:

The ray set files provided are general and can be used in most applications for all released CCTs, CRIs and holders. Specific ray sets for a certain color or holder are available on request, if needed.

Color consistency

Color consistency refers to the spread in color points between modules. It is specified in SDCM (Standard Deviation of Color Matching) or MacAdam ellipses, which are identical. The current general specification of all the Fortimo LED SLM modules is 3 SDCM. This results in an excellent color consistency performance. For SLM HE and HE+ versions, color consistency is even better: 2 SDCM. Fortimo SLM TW and CED module is within 3 SDCM for two-endpoint of tunable range.

Color targets

The color target points of the Fortimo LED SLM modules are found in the respective datasheets on www.Philips.com/Technology.

Spectral light distribution

The typical spectral light distributions of the Fortimo LED SLM colors are shown in the respective datasheets on www.Philips.com/Technology.

Complementary partners for Secondary Optics

Secondary optics is not part of the Fortimo LED SLM system offering. This is an added-value area for OEMs, offering the possibility to differentiate. The OEM can choose between reflectors and lenses. The use of reflectors is often preferred for a high light output ratio and glare shielding. Lenses however offer full beam control and can be more compact. There are many reflector companies who have a standard portfolio of compatible reflectors available, enabling quick and easy luminaire creation. A list of complementary partners offering compatible optics for Fortimo LED SLM modules is provided at the end of this document.

Reference to these products does not necessarily mean they are endorsed by Signify. Signify gives no warranties regarding these products and assumes no legal liability or responsibility for any loss or damage resulting from the use of the information given here.

Starting characteristics

The Fortimo modules light up milliseconds after being switched on, which is a general characteristic of LEDs.

Mechanical design-in

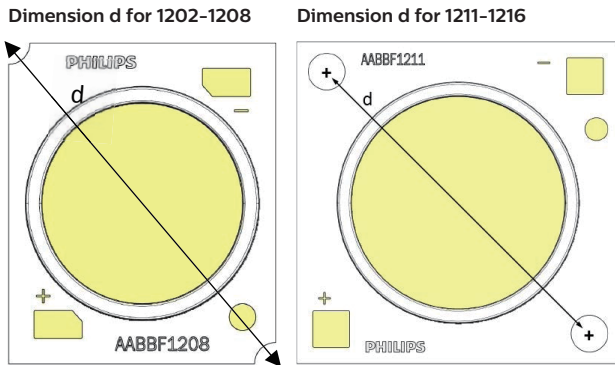

Fortimo LED SLM module dimensions

3D CAD files can be downloaded from our website www.Philips.com/Technology.

Basic dimensions for each module can also be found in the datasheets which are also available at the afore mentioned website.

Recommended torque

The recommended torque for mechanical fixation of the Fortimo LED SLM modules to the heat sink is 0.226 Nm (assuming pre-taped holes are present in the heat sink).

Wires for SLM Poke-in versions

The Poke-in holder supports 18-22 AWG (0.35 - 0.75mm²) solid, fused and stranded wires. It can be placed using M3 type crews.

Using the CoB without a holder

The Fortimo SLM CoBs can be used without a holder. For this, wires need to be soldered on. The following process can be followed:

- 1) The Fortimo SLM CoB can be directly mounted onto a heat sink with M2/M3 screws and electrical wires can be soldered onto the electrical pads.
 - Prepare the heat sink
 - a. Ensure that the heat sink surface is clean and flat ($\leq 25\mu\text{m}$), with no crowns or peaks in the mounting area; crowns or peaks on the heat sink surface may adversely impact the thermal conductance between the CoB and the heat sink.
 - b. Drill and tap two M2 or M3 screw holes according to the information in the picture on the left.
 - c. Wipe the heat sink surface clean with isopropyl alcohol (IPA).
 - d. Apply a thermal interface material (TIM) onto the heat sink.
- 2) Place the CoB onto the heat sink and align the screw slots in the substrate with the tapped screw holes in the heat sink.
- 3) Secure the CoB to the heat sink with two M2 or M3 screws. The screw down torque should not exceed 0.226Nm.

Fortimo SLM N COB	Outer Dimensions	Distanced: M2 Screws	Distanced: M3 Screws
1201	13.5mm x 13.5mm	NA	19.09mm
1202			
1203			
1204			
1205	19mm x 19mm	NA	26.87mm
1206			
1208			
1210	28mm x 28mm	NA	32.24mm
1211			
1212			
1216			
1812			
1818			

Fortimo SLM COB	Outer Dimensions	Distanced: M2 Screws	Distanced: M3 Screws
1202	12mm x 15mm	17.98mm	19.78mm
1203	16mm x 19mm	24.55mm	25.28mm
1204			
1205	20mm x 24mm	30.95mm	32.28mm
1208			
1211	28mm x 28mm	NA	32.28mm
1216			

Fortimo SLM VO COB	Outer Dimensions	Distanced: M2 Screws	Distanced: M3 Screws
1205	19mm x 19mm	NA	26.87mm
1206			
1208			
1211	28mm x 28mm	NA	32.24mm

Fortimo SLMs G8 UHE	Outer Dimensions	Distanced: M2 Screws	Distanced: M3 Screws
1309	20mm x 24mm	30.95mm	32.28mm
1319	28mm x 28mm	NA	32.28mm



Recommended soldering process.

Recommended soldering process

Wires can be directly soldered onto the CoB emitter. The following supplies are needed to do so.

- Grounded soldering iron, capable of reaching 350 °C (a soldering iron with a power level >30W is recommended)
- Stranded or solid copper wire – 24 gauge or larger
- Low-flux Sn96Ag4 solder wire
- Hot-plate, capable of reaching 100 °C (optional)

Follow the steps below to attach the wires to the CoB emitter.

Please note: It is highly recommended that the module's light emitting surface be covered when wires are soldered to the CoB emitter. If solder flux or debris lands on the light emitting surface, it will lead to performance impact and will void the warranty.

1) Prepare the wires.

- Cut the wires to size.
- Strip a few millimeters of insulating material from the ends of the wires.
- Pre-tin the wires with a small amount of solder.

2) Prepare the pads.

- Clean the pad.
- Place the tip of the soldering iron on the pad, apply solder and allow it to wet the pad.

3) Solder the wires to the pads.

- Place the pre-tinned wire on the pad.
- Place the tip of the soldering iron on the pad and allow the solder to reflow around the wire.
- Remove the soldering iron and allow the solder to joint to cool.

Recommendations

1) Preparation

- Wear the wrist strap before operation.
- Do not touch LED during the operation.
- Wire cross-section area should be 0.2...0.75 mm² (18...24 AWG), solid and fine stranded.

2) Soldering temperature

- Soldering bit temperature shall be 350 °C or less.
- The substrate of the CoB emitter is designed to dissipate heat quickly. This may make it difficult to get the temperature of the electrical pads to a point where the solder will reflow. Therefore, it is important to place the CoB emitter on a thermally insulating surface. Alternatively, place the CoB emitter on a pre-heated hot plate set to 100 °C.
- Do not place the soldering iron on the pad for more than 3 seconds.

Thermal design-In

The critical thermal management points for the LED module are set out in this chapter in order to facilitate the design-in of Fortimo LED spotlight modules (SLM). If these thermal points are taken into account, this will help to ensure optimum performance and lifetime of the LED system.

Optimum performance

To ensure optimum performance, the Fortimo LED SLM system must operate within specified temperature limits.

Test requirements

Measurements, e.g. of temperature, luminous flux and power, are reliable once the luminaire is thermally stable, which may take between 0.5 and 2 hours, and is defined as at least 3 readings of light output and electrical power over a period of 30 minutes taken 15 minutes apart with stability less than 0.5%. The time depends on the thermal capacity of the luminaire (see also the relevant clauses in IEC 60598-1).

Note:

Thermal stability can be considered if the temperature changes are less than 1 °C over three measurements taken 15 minutes apart. Measurements must be performed using thermocouples that are firmly glued to the surface (and not, for example, secured with adhesive tape).

Critical measurement points

Because LEDs are temperature sensitive, LED modules require a different approach with respect to the maximum permissible component temperature. This is different to most other types of conventional light sources.

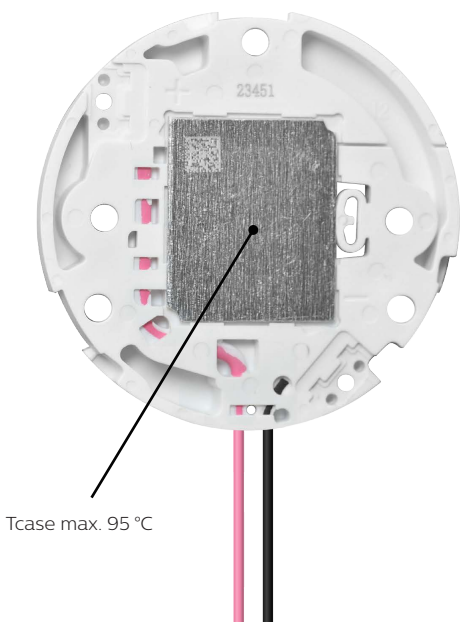

For LEDs the junction temperature is the critical factor for operation. Since there is a direct relation between the case temperature and the LED junction temperature, it is sufficient to measure the aluminum casing of the LED module at its critical point. The critical point is on the rear surface of the LED module, as shown in the figure on the left. If the case temperature (T_c) at the critical measurement point exceeds the recommended maximum temperature, the performance of the LEDs will be adversely affected, for example in terms of light output, lifetime or lumen maintenance.

To aid easy design-in of the Fortimo LED SLM, a T_{sense} point is introduced at the top side of the LED module. The T_{case} point at the back still remains leading. However, under certain circumstances, the temperature measurements on the T_{sense} point can be used to predict the temperature of the T_{case} point at the back of the module. For this purpose, there is a provision in the SLM holder (with the exception of the poke-in version) to feed through a thin thermal couple wire. The correlation between the T_{sense} point and the T_{case} point is influenced by the quality and performance of the thermal interface with the heat sink and the type and geometry of the heat sink. The correlation between T_{sense} and T_{case} has been calculated based on laboratory test with thermal paste and heat sinks with at least 3mm heat sink base thickness. If these conditions are the same, then a difference of $0.3^{\circ}\text{C}/\text{W}$ can be used. Results may vary case by case, and it is best if the measurement reference is made at the customer, using the luminaire in question. It is also important to note that the T_{case} temperature is always leading. If support is needed please ask your Signify representative about our design-in service.

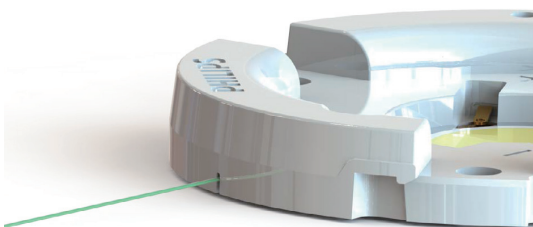
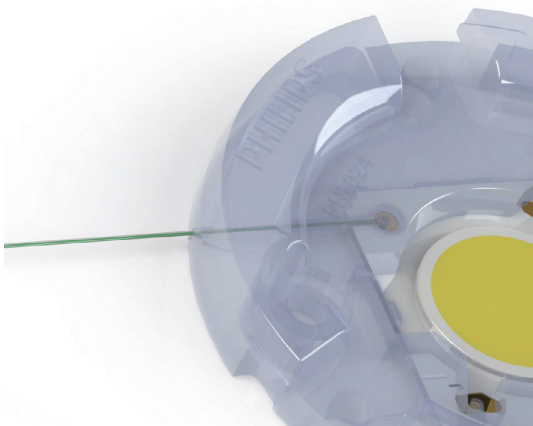

Thermocouple Wire fed through provision in holder

Tc-nominal and Tc-max

With the introduction of Fortimo LED SLM the luminaire manufacturer is enabled to make their luminaire even more compact due to a smaller heat sink. For this, Tc-max has been introduced. The Tc-max value for the Fortimo LED SLM is set to 95 °C and it is the maximum temperature at which the Philips Fortimo LED SLM modules can be operated. Please contact your Signify representative for detailed product specs in that case. At Tc-nominal of 85 °C (only in combination with a current setting within the Warranty Window) all the specifications mentioned in the Fortimo LED SLM commercial leaflet, datasheets and design-in guide are valid and a 5 year system warranty is applicable in combination with a Philips Xitanium LED driver.



Warnings:

The Fortimo LED SLM does not incorporate the NTC feature of the Fortimo LED SLM Gen3 when connected to a Xitanium LED driver. Special care needs to be taken for active cooled solutions. Please ensure that your operating current is within limits for the CoB.

Note:

With no Rset connected to the driver/current set via DALI or SimpleSet the driver goes to its default current (specified in the driver datasheet). This default current must also be less than the maximum current specified for the module.

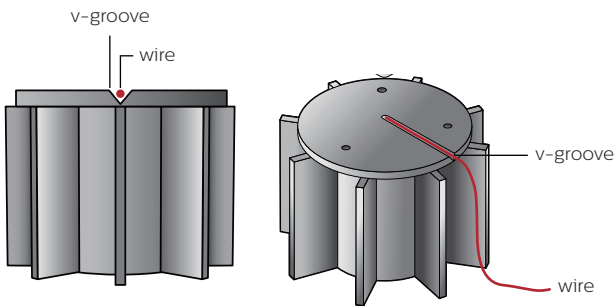

Thin v-groove in the heat sink to embed a thermocouple

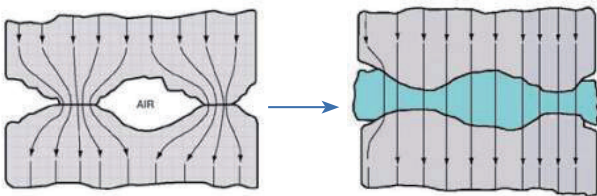

The working principle of thermal interface material (TIM)

How to measure the critical temperature point T_c

The T_c temperature can be measured by making a thin v-groove or a small drill hole in the heat sink to reach the bottom of the LED module. Be sure to measure the temperature of the bottom of the module and not of the thermal interface material (TIM).

Thermal interface material

The function of a thermal interface material is to reduce thermal impedance between the LED module and the heat sink. The thermal interface material replaces air, which is a thermal insulator, by filling the gaps with material that has better thermal conductivity. This is shown diagrammatically in the figure on the left.

In general:

- Thermal paste performs better than thermal pads.
- The lower the thermal impedance the better.
- The thickness of the TIM should relate to the surface roughness and flatness of the used heatsink.

Due to the small footprint of the Fortimo SLM, it is more sensitive to roughness and surface quality of the heat sink counter surface. It is highly recommended to have this surface clean and free of burs before applying the thermal interface material and the SLM module.

A list of complementary partners for thermal interface material products that can be used with the Fortimo LED SLM module can be found at the end of this document. Reference to these products does not necessarily mean they are endorsed by Signify. Signify gives no warranties regarding these products and assumes no legal liability or responsibility for any loss or damage resulting from the use of the information given here.

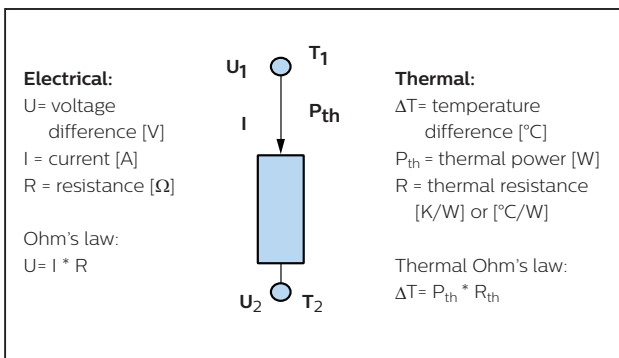

Electrical and thermal analogy

For the Fortimo LED SLM it is recommended to use a thermal paste or phase change material as Thermal Interface Material (TIM). Please also be aware that an electrically insulating phase change material will introduce a thermal penalty compared to nonelectrically isolating phase change material. Thick thermal interface materials are not recommended.

Electrical and thermal analogy

Standard static thermal situations can be modeled using 'thermal resistances'. These resistances behave like electrical resistances. The analogy between electrical and thermal resistances is explained in the figure entitled 'Electrical and thermal analogy' on the left. The electrical units are shown on the left, while the thermal equivalents are given on the right. With a known voltage difference at a certain current it is possible to calculate the electrical resistance using Ohm's law. The same applies for a thermal resistance. If the temperature difference and the thermal power are known, the thermal resistance can be calculated using the thermal Ohm's law. Please note that using the concept of thermal resistances is a strong simplification of the actual physics of heat transfer, to aid in understanding of heat flow and temperature.

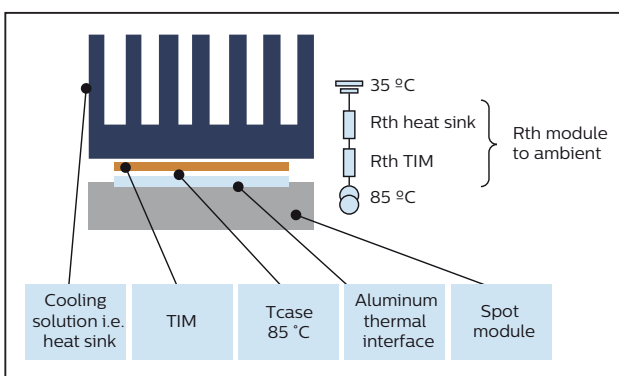

Thermal model

Thermal model

A thermal model that can be used to determine the required thermal performance of the cooling solution for the LED module is shown in the figure on the left.

A simplified model of the thermal path from LED module to ambient; T_c of 85 °C is used as an example.

Thermal design of a heat sink

A successful thermal design-in means that the T_c temperatures of the LED module is within thermal specifications at given maximum operating ambient of the luminaire.

Remarks:

- For track spot lighting applications, a minimum of 25 °C design ambient is recommended.
- For recessed spot lighting applications, a minimum of 35 °C design ambient is recommended.

If the expected maximum operating ambient for the luminaire is <25 °C ambient, the luminaire still needs to be tested within thermal specifications of T_{case} nominal in a lab environment at 25 °C ambient.



Warnings:

The maximum temperature difference between T_c and $T_{ambient}$ should not exceed 60 °C for SLM, otherwise it could lead to a reduction in the lifetime of the system.



Warnings:

Due to the increased T_{case} nominal temperature of the Fortimo LED SLM to 85 °C, it is important to take into account the maximum touchable metal surface temperatures of the luminaire during design. With such a high T_{case} temperature the maximum temperature for touch safety can easily be exceeded.

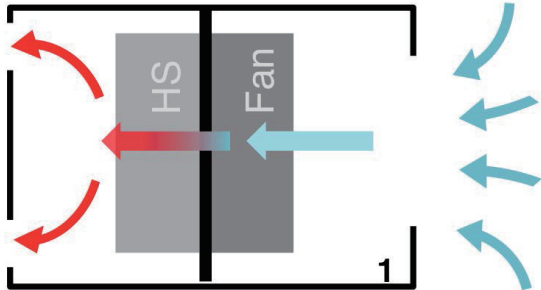

1. Design guidelines for active cooling solutions

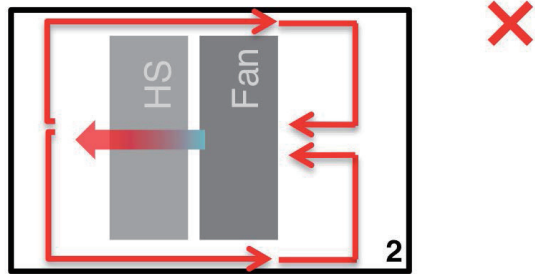

2. Design guidelines for active cooling solutions

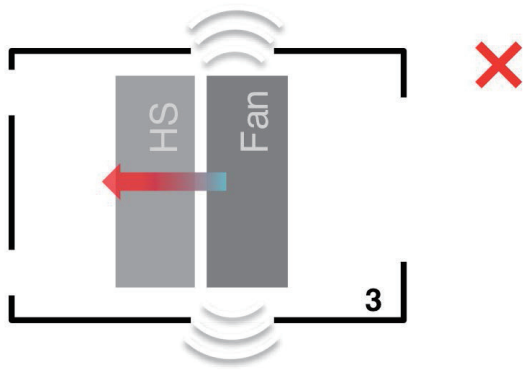

3. Design guidelines for active cooling solutions

Active and passive cooling

In theory two thermal solutions are possible.

Active cooling

With this method the air is forced to flow by means of a fan or membrane, which enhances the thermal dissipating capacity of the heat sink. As a result, a smaller heat sink can be used and the orientation of the heat sink has less impact on the thermal performance. A potential side effect is that the fan or membrane might produce noise and consume extra energy.

Furthermore, the specified lifetime of the fan should match that of the application.

Design guidelines for active cooling

Design guidelines for active cooling include:

- The luminaire should be equipped with an inlet for cool air and an outlet for hot air (Image 1).
- The airflow from the inlet to the outlet should be smooth and without restriction in order to limit vibration, recirculation and noise.
- Recirculation of hot air (Image 2) inside the luminaire should be prevented, as this will lead to a lower thermal performance and higher noise level.
- Unnecessary openings near the fan in the luminaire housing (Image 3) should be avoided in order to help contain any noise from the fan.

Passive cooling

Passive cooling systems are based on the fact that hot air moves upwards, thus creating airflow along the surfaces. This is called natural convection. There are many standard heat sinks available, but it is also possible to design your own heat sink.

In general, a passive cooling solution requires a larger heat sink than an active cooling solution.

Design guidelines for passive cooling

Before starting to perform any calculations, an important point to consider is the airflow. In general hot air moves upwards at a relatively low speed. The shape and position of the heat sink will affect the airflow. Ideally, the fins should be parallel to the direction of airflow. Closure of the top of the profile will reduce the cooling capacity of the heat sink and should therefore be avoided during design and installation.

Some additional design guidelines for passive cooling include:

- Limit the number of thermal interfaces in the thermal path from module to ambient.
- Thick fins conduct heat better than thin fins.
- Large spacing between fins is better than small spacing between fins.
- Make cooling surfaces more effective by using proper conductive materials, appropriate thickness and correct fin orientation.
- Thermal radiation plays a significant role => anodized or powder-coated surfaces are preferable to blank surfaces.

Complementary thermal solution partners

Thermal solutions do not form part of the Fortimo LED SLM system offering. This is an added-value area for OEMs, offering the possibility to differentiate. However, there are many thermal solution companies who have a standard portfolio of compatible heat sinks available, enabling quick and easy luminaire creation. A list of complementary partners offering compatible cooling systems for Fortimo LED SLM modules can be found at the end of this document.

Reference to these products does not necessarily mean they are endorsed by Signify. Signify makes no warranties regarding these products and assumes no legal liability or responsibility for any loss or damage resulting from the use of the information given here.

Electrical design-in and flexibility

Connection to the mains supply

The mains supply must be connected to the LED driver (Line and Neutral can be interchanged).

Isolated LED Drivers

The Fortimo LED SLM products are designed to be used with Class 2 output LED drivers (NA region) or SELV output (Uout 60V) LED drivers (such as EMEA and APR regions where national norms harmonize with IEC standards).

This allows for an easier and safer design-in with no isolation required on the luminaire.

Tune the luminaire's flux (lm) and efficacy (lm/W)

The LED SLM specifications are provided under nominal conditions, like nominal flux at nominal current. It is however possible to deviate from this nominal current. By altering the current, we can obtain different flux outputs. At the same time, the required forward voltage (Vf) also changes, leading to a change in the efficacy (lm/W). The following sections explain the impact and boundaries.

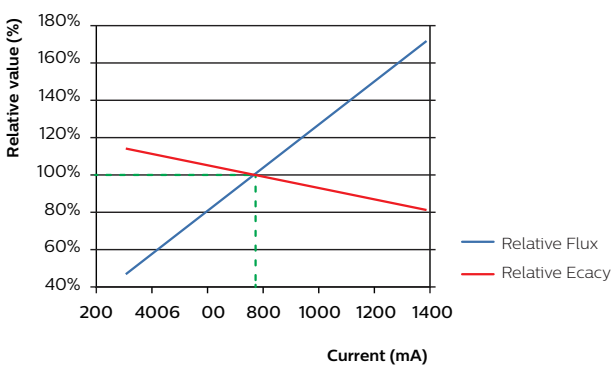

Example graph showing flux and efficacy as a function of current

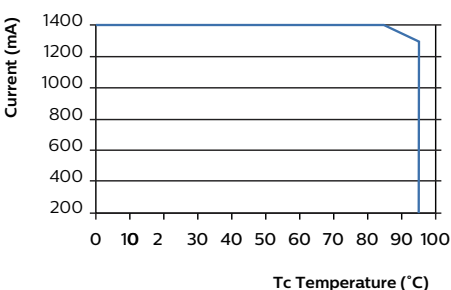

Example warranty window

Effect of Choosing a different current value

In case the customer chooses to set the current (either by programming or by applying an Rset resistor) other than nominal, the lifetime and reliability of the LED SLM must be taken into account. The following current regions can be distinguished:

1. Current < nominal current* (mA)
 - a. Efficacy (lm/W) higher than nominal value
lumen output (lm) lower than nominal value
 - b. Lifetime > 50,000 hours
2. Current between nominal current and absolute maximum current** (mA). Your warranty may be affected in this case.
 - a. Efficacy (lm/W) lower than nominal value
lumen output (lm) higher than nominal value
 - b. Lifetime **may be** < 50,000 hours
3. Current > absolute maximum current: do not exceed the absolute maximum current as this can lead your LED SLM module to failure. No warranty applicable in this case.

50,000 hours above is an example, please refer to the datasheet for the exact lifetime of the module

Note:

You must check if your chosen operating point falls within the warranty window stated in the datasheets along with the flux tuning graphs as shown on the left. The warranty is applicable for the Philips Fortimo LED SLM modules for 1 switching cycle per day in combination with a SELV driver.

The rated average life is based on engineering data testing and probability analysis. The hours are at the L70B50 point.

* Nominal current at which performance and lifetime is specified

** Maximum current tested for safety

Set the output current via Rset

By making use of a resistor component with a determined Ohmic value you can set the required current for your LED module. This component can be a leaded standard 1% tolerance resistor of e.g. 0.125 W or 0.25 W, 50 V. The Rset will not be part of the electrical chain driving the module.

An example of a resistor placed into the drivers' input is shown on the left.

Three different Rset resistors are utilized in the Xitanium Indoor Spot and Downlight LED driver portfolio:

Rset1 (older drivers)*; allows output current setting up to 700 mA

Rset2; allows output current setting up to 2000 mA

LEDset: Allows output current setting upto 8000 mA

In all documentation, Rset may refer to either Rset1, Rset2 or LEDset, depending on the driver type.

Please check the driver datasheet for which Rset the driver you use reads. You can find this at www.Philips.com/Technology.

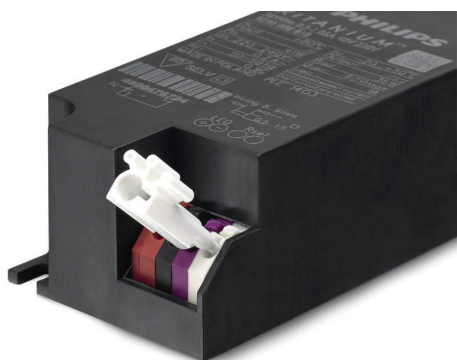

Poke-in Rset inserted in a driver



JST Rset inserted in a driver

Note:

The Rset must be inserted such that there is no mechanical pressure on it from the driver casing being closed.

Rset1 and Rset2 use different pins on the driver (and on the JST connector). The Rset1 and Rset2 values with the corresponding drive currents are shown in the DIG for drivers and on the Easy Design-in tool at www.easydesignintool.com. It is advised to select the nearest lower resistor value that is available to you, if the exact determined value is not at hand.

* All future drivers will support LEDset.

Warnings:

Please note that changing the rset on the module changes the current and voltage at which the module operates. You may have to adapt your design accordingly. In case no Rset is used, please check the default setting of your driver. This current may be higher than what your CoB can handle!

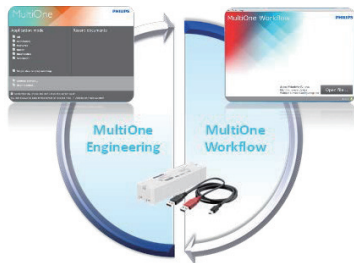

Programming the output current

The Xitanium TD drivers offer a full range of controls, enabling customizable luminaire design and performance. It is possible to control light output levels, preset dimming protocols and set system specifications in the factory and even in the complete installations. This can be done with the Philips MultiOne configurator.

The MultiOne configurator is an intuitive tool that unlocks the full potential of all programmable Philips drivers, ensuring that the driver performance matches the needs of the lighting solution. It offers unprecedented flexibility, before, during and after the product installation.

With the latest selected drivers, SimpleSet® functionality is also supported via MultiOne. Please check the datasheet of the driver on www.philips.com/technology to know if your driver supports SimpleSet® or not.

For more information on MultiOne visit: www.philips.com/multiOne

This site contains detailed information on how to install the software and how to program the driver.

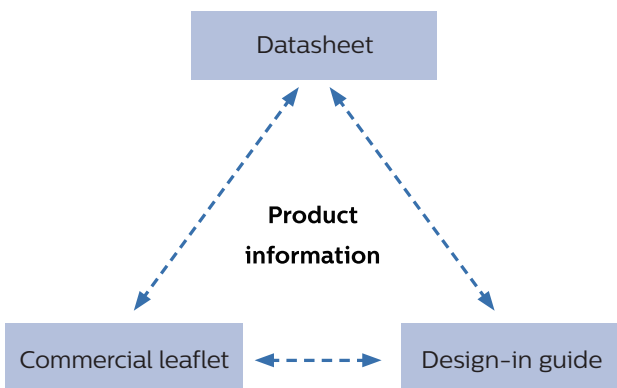

Xitanium Indoor Spot and Downlight LED drivers

For the drivers, the same documentation philosophy holds as for the LED modules, meaning that also three documents make up the full information set of the drivers.

For detailed info, please refer to these documents for your driver on www.Philips.com/Technology.

Compatible Drivers with SLM

A list of compatible drivers, specific to your choice of module and operating point can be obtained from the Easy Design-in Tool that can be found at www.easydesignintool.com. In case of queries, please contact your Signify representative.

Human Centric Lighting solutions

Light is not only a means to make our world visible. It influences the biological and emotional processes in human beings as well. Signify offers several Human Centric Lighting solutions. The Quality of Light and Visual Comfort has been included in our portfolio for years. Nowadays, we also offer systems that improve biological and emotional functions.

Cyan Enhanced Spectra

We created a series of LED-modules with a spectrum that stimulates the biological effects on the circadian rhythm of natural light whilst still providing comfortable light of high quality.

Connected Lighting Systems – MasterConnect

Use MasterConnect wireless driver to create a connected lighting system. These systems allow you to do wireless control, ranging from very simple, local systems to large systems that can be integrated into Building Management Systems.

How to configure MC FlexTune Wireless driver by MultiOne?

1. Configuration Interface

All available MultiOne Interfaces can be used, both the wired DALI as the wireless SimpleSet versions. In case of a DALI Interface, connect the DALI interface to the driver. Power up both the interface and the driver. In case of a Simple Set Interface, power up the Interface (using the power supply to mains or USB-connection to your computer) and place the Interface antenna close to the SimpleSet antenna of the driver.

2. Setting the parameters

Start up the MultiOne software. The software will search for the driver in its library. Once the driver has been recognized, click on the FlexTune line in the left side menu bar. The screen left will appear.

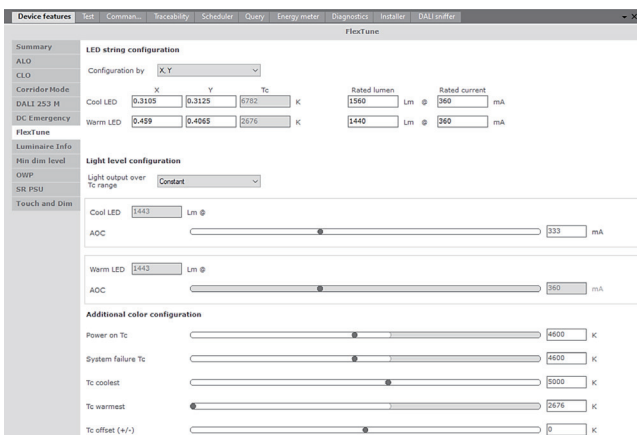

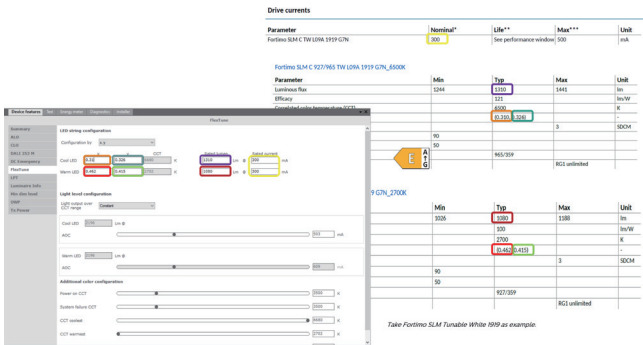

LED string configuration in MultiOne

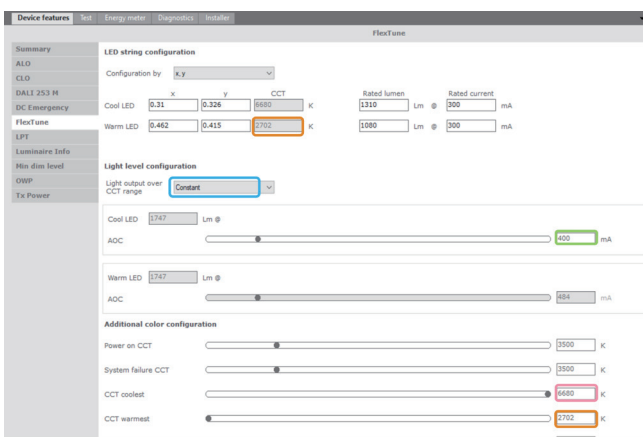

Light level configuration in MultiOne

1) The color points and efficacies of both the cool as the warm LED must be filled in. These values can be found in the datasheet.

2) Under Light level configuration, choose the default value Constant and set the required current setting for the cool CCT. Based on the known color points and efficacies, the driver will calculate the proper current setting for the warm CCT. In this case we choose 400mA, resulting in 2889 lumen for the cool CCT. The calculated current for this flux of the warm CCT is 485 mA.

3) An important setting is the Tc coolest. This is the coolest CCT that can be achieved with this system, which is 6551K. The Tc warmest is 2719K, see under LED String Configuration.

For CED SLM module, the coolest CCT should be set as **5000K** to make sure CRI80 is available during whole tuning range.

All other MultiOne settings are not FlexTune specific and can be set as required.

Notes:

- The values of the Cool LED under LED String Configuration are virtual. There is no physical LED on the module with this CCT. They are used for calculation purposes only.
- For more information, we refer to:
Drivers: Design-in Guide Xitanium SR Drivers
Multi-One:
<https://www.lighting.philips.co.uk/oem-emea/products/philips-multione-configurator>

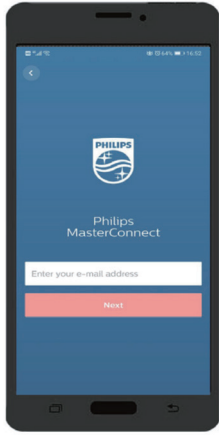

Philips MasterConnect App



Philips Wireless Switch

Tuning via MC APP and Switch

Working with Philips MasterConnect App

The FlexTune system (Fortimo SLM CED module with Xitanium Wireless FlexTune driver) can be controlled by Philips MasterConnect APP as standalone or in a mesh network to enable

Tunable white, wireless dimming, task turning, grouping, scene setting and other wireless control functions.

A more detailed explanation of the capabilities of this system and how it can precisely control color tuning is located in the user manual found here:

<https://www.lighting.philips.co.uk/oem-emea/support/technical-downloads>

Or contact your local Philips sales representative.

Working with Philips Wireless Switch

Philips Wireless Switch works as an optional lighting control accessory in the network which set up by Philips MasterConnect App. It can realize wireless dimming or scene setting function. More information can be found in its datasheet and commissioning procedure. These documents can be downloaded via

<https://www.lighting.philips.co.uk/oem-emea/support/technical-downloads>

Or contact your local Philips sales representative.

Reliability

Lumen maintenance

L70B50 @ 50,000 hours

The quality of the LED SLM portfolio is backed by the claim of B50L70 @ 50,000 hours. This means that at 50,000 hours of operation at least 50% of the LEDs' population will emit at least 70% of its original amount of lumens.

This is contrary to conventional light sources, where some time after Service Life Hours the conventional light source emits no light at all.

In this section the example graphs show the estimated lumen depreciation curves for different percentage of the population and at nominal Tc temperatures. The actual data for the LED SLM modules can be found in the associated datasheet at www.Philips.com/Technology.

Average rated life is based on engineering data testing and probability analysis. The Fortimo LED SLM modules are specified to reach L70B50 for the nominal specifications.

Lumen maintenance for B10 and B50

Lumen maintenance values can be found in the datasheets. An example of a lumen maintenance table is shown below. The data are based on LM80 data.

Lumen maintenance

Operation point	Lumen maintenance x 1000 hours	L70			L80			L90		
		B50	B20	B10	B50	B20	B10	B50	B20	B10
80% 1 nom 192 mA	Tc 25 °C	>70	>70	>70	>70	>70	>70	67	64	62
	Tc nom 45 °C	>70	>70	>70	>70	>70	>70	52	50	49
	Tc life 70 °C	>70	>70	>70	>70	>70	>70	40	38	37
1 nom 240 mA	Tc 25 °C	>70	>70	>70	>70	>70	>70	67	64	62
	Tc nom 45 °C	>70	>70	>70	>70	>70	>70	52	50	49
	Tc life 70 °C	>70	>70	>70	>70	>70	>70	40	38	37
1 life 480 mA	Tc 25 °C	>70	>70	>70	>70	>70	>70	58	55	54
	Tc nom 45 °C	>70	>70	>70	>70	>70	>70	45	43	42
	Tc life 70 °C	>70	>70	>70	>70	>70	>70	35	33	32

The L70B50 value is the number of hours after which 50% of the population emits at Least 70% of the initial flux.

The L80B10 is the number of hours after which 90% of the population emits at least 80% of the initial flux.

Controllability

Dimming the Philips Fortimo LED SLM system

As a system, the Philips Fortimo LED SLM and Xitanium dimmable drivers support dimming between 100% and 1%, depending on the driver specification. The Xitanium driver range supports various dimming protocols.

Please refer to the driver design-in guide for more detailed information.

Further information about our entire portfolio of control products is available at:
www.Philips.com/lightingcontrols.

Complementary partners

Complementary reflector partners	
Jordan	www.jordan-reflectoren.de
NATA	www.nata.cn
LEDIL	www.ledil.com
BJB	www.bjb.com
Almeco	www.almecogroup.com
LEDLink	www.ledlink-optics.com
Darkoo	www.darkoo.cc

Complementary lens partners	
LEDIL	www.ledil.com
NATA	www.nata.cn
CK Optics	www.ckoptics.com
Darkoo	www.darkoo.cc
LEDLink	www.ledlink-optics.com
Carclo	www.carclo-optics.com

Thermal interface partners	
Laird Technologies	www.lairdtech.com
The Bergquist Company	www.bergquistcompany.com

Complementary heat sink partners	
Sunon	www.sunon.com
AVC	www.avc.com.tw
Wisefull	www.wisefull.com
MechaTronix	www.mechatronix-asia.com

Compliance and approval

Compliance and approbation

The modules bear the CE mark indicating that they comply with the appropriate European EU directives. SLM modules will also be ENEC+ certified (except with the combination of the poke-in holder).

The relevant standards are summarized below. To ensure luminaire approval, the conditions of acceptance need to be fulfilled. Details can be requested from your local sales representative. All luminaire manufacturers are advised to conform to the international (luminaire standards IEC 60598-1) and national standards of luminaire design.

IP rating, humidity and condensation

The Fortimo LED SLM modules are build-in modules relying on the luminaire for environmental protection. They have no IP classification. They are not designed for operation in an unprotected open air environment. Fortimo LED SLM modules are not suitable for direct exposure to moisture, dust, chemicals, salt, etc. The Fortimo LED SLM module has been developed and released for use in dry or damp locations. If there is a possibility that condensation could come into contact with the modules, the system/luminaire builder must take precautions to prevent this. The OEM is responsible for proper IP classification and approval of the luminaire.

Fortimo SLM HE / UHE products, though they are robust enough to pass the same Signify internal reliability testing, are still more sensitive compared to regular Fortimo SLM products.

Fortimo SLM HE / UHE products may not be able to maintain their specified performance over life if being used in a high temperature and / or high humidity environment.

Electrostatic discharge (ESD)

ESD in production environment

Depending on the protection level of the LED module a minimum set of measures has to be taken when handling LED boards.

Switching cycles versus case temperature

The Fortimo LED SLM module lifetime expectancy can be affected by thermal cycling. Thermal cycling can cause wire bonding fatigue if the thermal rise of the module increases too quickly in a given period of time. Continuously cycling with this condition will cause shortened product life. Specific cycling versus module case temperature information for the Fortimo LED SLM modules can be found in the product datasheet.

Some facts on blue light

- All light; visible, IR and UV, causes fading
- It has long been known that blue light causes fading in yellow pigments
- LEDs do not produce more blue light than other sources by its nature

“Often, investigations into the effect of short-wavelength radiation—be it on humans or artwork—suggest that LEDs are dangerous because they emit more blue light than other sources like incandescent bulbs or CFLs. While it is true that most LED products that emit white light include a blue LED pump, the proportion of blue light in the spectrum is not significantly higher for LEDs than it is for any other light source at the same correlated color temperature (CCT).”

Environmental compliance

The photobiological safety standard IEC 62471 (‘Photobiological safety of lamps and lamp systems’) gives guidance on how to evaluate the photobiological safety of lamps and lamp systems including luminaires. This standard specifies the exposure limits, reference measurement technique and classification scheme for the evaluation and control of photobiological hazards from all electrically powered incoherent broadband sources of optical radiation including LEDs in the wavelength range from 200 nm through 3000 nm. Measured results of emission limits for Fortimo LED SLM modules using the non-GLS (20 cm) method are listed in the datasheets that can be found at www.Philips.com/Technology.

Blue Light Hazard

From the nature of most LEDs applying blue light, emphasis has been put on the hazard in terms of Photo Biological Safety (PBS). Evaluation by the European lighting industry (ELC, Celma) has concluded LED light sources are safe for customers when used as intended. A photobiological safety report is available at www.Philips.com/Technology. Nevertheless luminaire makers have to comply with luminaire standards including PBS. To avoid extensive retesting, it is preferred to build on the test conclusions of the LED (module) suppliers; however this should be discussed and agreed upon with the used certification body. The testing conclusion then will be expressed in Risk Groups (RG), where RG0 and RG1 are considered safe and/or do not require specific action for the luminaire makers (as compared to RG2 and 3).

CrispWhite Technology

Fortimo LED SLM CrispWhite modules provide the user with intense whites and rich colors. Please note that the product has no UV wavelengths being emitted. A number of materials have been tested in combination with the crisp white light and the results are promising. When tested with PMMA, PC reflectors and silicone reflectors, under different temperature and light conditions, no photo-ageing effect from the deep blue flux is observed. If more information is needed, please contact your Signify representative.

Chemical Compatibility

The CoB contains a silicone overcoat to protect the LED chip and extract the maximum amount of light. As with most silicones used in LED optics, care must be taken to prevent any incompatible chemicals from directly or indirectly reacting with the silicone. The silicone overcoat used in the CoB is gas sensitive. Consequently, oxygen and volatile organic compound (VOC) gas molecules can diffuse into it. VOCs may originate from adhesives, solder fluxes, conformal coating materials, potting materials and even some of the inks that are used to print the PCBs.

When used in industry, heavy traffic and outdoor environments, the LED module must be properly shielded from ingress of sulfur and chlorines. The usage of IP enclosed luminaire solutions does not eliminate the risk of ingress of these corrosive gasses. Proper testing is required to validate LED luminaire designs. In addition, the components used in the luminaire should be clean from corrosive VOCs. A chemical compatibility check needs to be performed for the particular industrial environment and the components used in the luminaire. Please consult us if you wish to deviate from the design rules described in this guide.

A list of commonly used chemicals, that should be avoided as they may react with the silicone material, is provided on the left. Note that Signify does not warrant that this list is exhaustive since it is impossible to determine all chemicals that may affect LED performance. These chemicals may not be directly used in the final products but some of them may be used in intermediate manufacturing steps (e.g. cleaning agents). Consequently, trace amounts of these chemicals may remain on (sub) components, such as heat sinks. It is recommended to take precautions when designing your application.

Chemical Name	Type
Hydrochloric acid	acid
Sulfuric acid	acid
Nitric acid	acid
Acetic acid	acid
Sodium Hydroxide	alkali
Potassium Hydroxide	alkali
Ammonia	alkali
MEK (Methyl Ethyl Ketone)	solvent
MIBK (Methyl Isobutyl Ketone)	solvent
Toluene	solvent
Xylene	solvent
Benzene	solvent
Gasoline	solvent
Mineral spirits	solvent
Dichloromethane	solvent
Tetrachlorometane	solvent
Castor oil	oil
Lard	oil
Linseed oil	oil
Petroleum	oil
Silicone oil	oil
Halogenated hydrocarbons (containing F, Cl, Br elements)	misc
Rosin flux	solder flux
Acrylic Tape	adhesive

Cautions

During storage and transportation

- Store in a dark place. Do not expose to sunlight.
- Maintain temperature between -40 $+80$ °C, and RH 5 – 85%.

During operation

Signify shall not be held responsible or liable for any damage, costs or expenses to the user, resulting from an accident or any other cause during operation if the system is used without due observance of the absolute maximum ratings and other instructions provided by Signify.

Note:

That warranty is applicable for the Philips Fortimo LED SLM modules for 1 switching cycle per day in combination with a SELV driver.

Contact details

Signify

www.Philips.com/Technology

Or contact your local Signify sales representative

Design-in Support Terms & Conditions for EMEA

These Design-in Support Terms and Conditions (“**these Terms**”) apply to all design-in support (“**Support**”) provided by **Signify** (through its Business Group LED Electronics) (“**Signify**”) to a customer requesting the Support (“**Customer**”).

Any report provided by Philips Lighting in connection with the Support is not an official testing certificate and cannot be used or construed as a document authorizing or otherwise supporting an official release of the luminaire. The Customer remains at all times liable and responsible for any and all required testing and approbation prior to the manufacture and sale of the luminaire in question.

The testing performed by Philips Lighting, as well as the scenarios, observations, conclusions, recommendations and other results or advice contained in any report provided by Philips Lighting in connection with the Support, are provided solely for informational purposes for internal evaluation by the Customer. Philips Lighting does not make and hereby expressly disclaims any warranties or assurances whatsoever as to the accuracy, completeness, reliability, content and/or quality of any testing, scenarios, observations, conclusions, recommendations and other results or advice contained in any reports or any other document provided in connection with the Support, whether express or implied including, without limitation, any warranties of satisfactory quality, fitness for a particular purpose or non-infringement. Philips Lighting has not investigated, and is under no obligation or duty to investigate, whether the scenarios, observations, conclusions, recommendations and other results or advice contained in any report provided in connection with the Support are, or may be, in conflict with existing patents or any other intellectual property rights. The scenarios, observations, conclusions, recommendations and other results or advice contained in any report or any other document in connection with the Support are provided by Philips Lighting on an “as is” basis, at the customer’s sole risk and expense.

Philips Lighting shall not be liable to the Customer for any damages (whether direct damages, lost profits, lost savings, loss of reputation, loss of goodwill, indirect, incidental, punitive, special or consequential damages) arising out of or in connection with the Support provided by Philips Lighting (including resulting from the use of any report, implementing any recommendations, and/or interactions of the solution in the later produced luminaries, the application of the luminaries or otherwise) whether or not such damages are based on tort, warranty, contract or any other legal theory – even if Philips Lighting has been advised, or is aware, of the possibility of such damages.

The laws of the Netherlands govern these Terms and any disputes that cannot be settled through consultation in good faith within thirty (30) days after notice from either the Customer or Philips Lighting that a dispute exists, will be referred to and finally resolved by the exclusive jurisdiction of the courts of Amsterdam, The Netherlands.

These Terms shall constitute the entire agreement between Philips Lighting and the Customer relating to the subject matter hereof. Any waiver of these Terms shall only be effective if it is in writing and signed by Signify. If any part of these Terms is found invalid or unenforceable by a court of competent jurisdiction, the validity and enforceability of the remaining provisions or portions of them, will not be affected.



© 2025 Signify Holding, IBRS 10461, 5600VB, NL. All rights reserved.

www.philips.com/Technology

The information provided herein is subject to change, without notice. Signify does not give any representation or warranty as to the accuracy or completeness of the information included herein and shall not be liable for any action in reliance thereon. The information presented in this document is not intended as any commercial offer and does not form part of any quotation or contract, unless otherwise agreed by Signify.

Philips and the Philips Shield Emblem are registered trademarks of Koninklijke Philips N.V. All other trademarks are owned by Signify Holding or their respective owners.

27 August 2025
Data subject to change