



Lightolier LED Downlight dual select provides an easy to install solution. The CCT and Lumen selection features make it easy to adjust at the time of installation.

Project: _____
 Location: _____
 Cat.No: _____
 Type: _____
 Qty: _____
 Notes: _____

Fixture

example: DL3RSLMZ10SCTUW

Family	Size	Lumens	Dimming	CCT / CRI	Voltage	Finish
DL						
DL Downlight dual select	3R 3in Round	SLM Field Selectable (370lm/500lm)	Z10 0-10V	SCT Field Selectable 5CCT (2700K, 3000K, 3500K, 4000K & 5000K)	U UNV	W White (matte)
	4R 4in Round	7 700lm SLM Field Selectable (540lm/700lm)	E TRIAC to 5% Z10 0-10V	SCT Field Selectable 5CCT (2700K, 3000K, 3500K, 4000K & 5000K)	1 120V U UNV	
	6R 6in Round	11 1100lm SLM Field Selectable (900lm/1100lm)	E TRIAC to 5% Z10 0-10V	SCT Field Selectable 5CCT (2700K, 3000K, 3500K, 4000K & 5000K)	1 120V U UNV	

Features

- 1. Flange:** Die cast aluminum (white paint).
- 2. Junction Box:** Extruded aluminum steel. Clip attached on the side of the junction box to connect with fixture or new construction plate to meet NEC (National Electric Code).
- 3. Lifetime:** L70 at 50,000 hours and backed by a 5-year warranty.

Electrical

Electronic power supply: RoHS compliant. Class 2 power unit. Remote power supply can only accommodate one LED module and cannot be shared with other LED module. Fixture can be daisy chained and cannot be through wired.
Dimming: Intended for ELV/TRIAC (120V) and 0-10V (UNV) dimming please review ordering chart to see available options.

Labels

cETLus listed
 Ceiling-mounted: suitable for damp location.
 ENERGY STAR®
 Title 24
 IC Rated (max. operating environment temp 25°C)
 AirSeal for minimal air leakage

Lumen Values

	Lumen Output	Input voltage	Input freq	Max. Input current	Max. Input power	Max. THD	Power factor	CRI	Min. Operating Temp.	Max. Operating Temp.
3" Round UNV	370lm/500lm	120V - 277V	50/60Hz	0.20A	8W	20%	0.9	90	-20°C	40°C
4" Round 120V	700lm	120V	60Hz	0.25A	11W	20%	0.9	90	-15°C	40°C
4" Round UNV	540lm / 700lm	120V - 277V	50/60Hz	0.25A	11W/9W	20%	0.9	90	-20°C	40°C
6" Round 120V	1100lm	120V	60Hz	0.38A	15W	20%	0.9	90	-15°C	40°C
6" Round UNV	900lm / 1100lm	120V - 277V	50/60Hz	0.38A	15W/13W	20%	0.9	90	-20°C	40°C

DL Downlight dual select

3", 4" & 6" Round

Dimensions

Downlight 3" Round

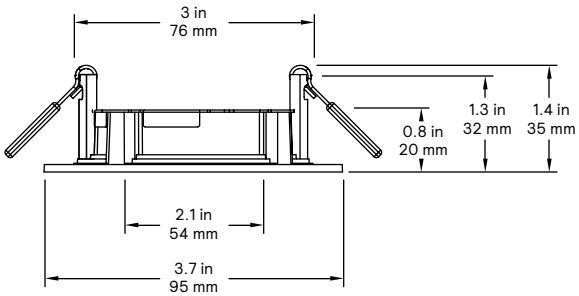

Downlight 4" Round

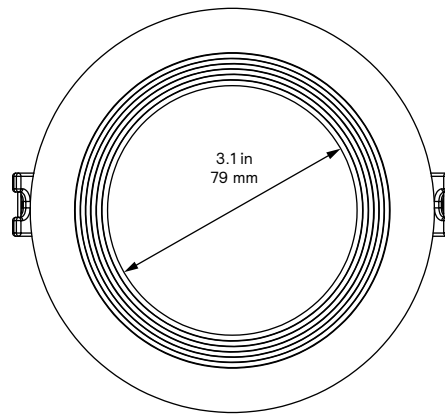
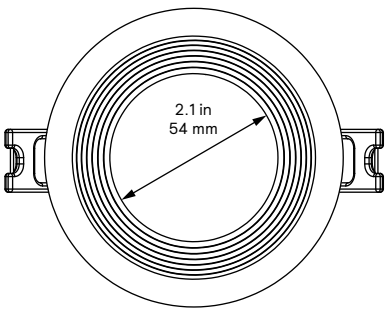
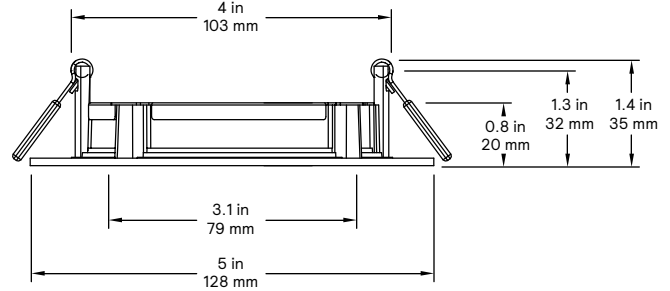

Downlight 6" Round

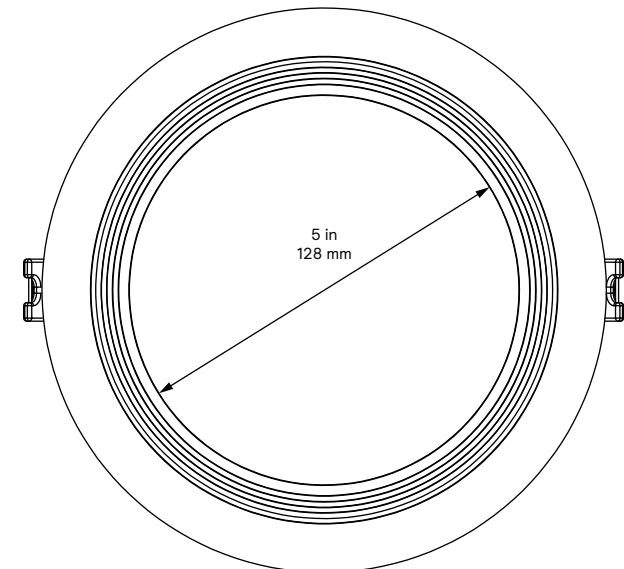
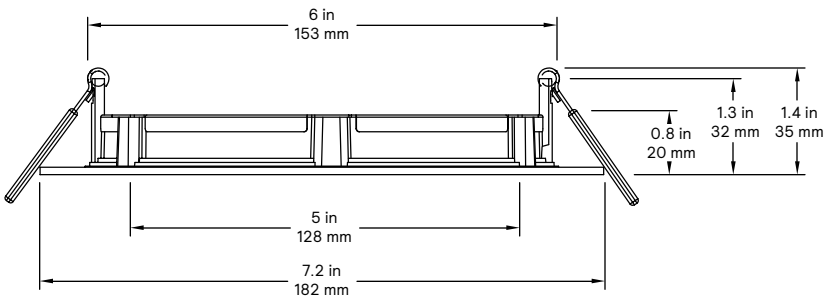

DL Downlight dual select

3", 4" & 6" Round

3RSLMZ10SCTUW • 3" Round, Field Selectable, Universal Voltage, White Finish

Candela Curve

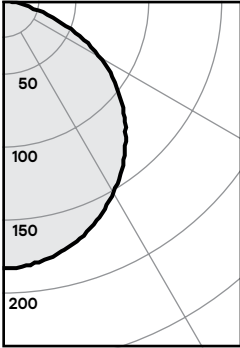

Fixture: 3RSLMZ10SCTUW

Output lumens: 489 lms
 Input watts: 7.9 W
 CRI: 90 (min)
 CCT¹: 2700K
 Beam Angle: 110°
 Spacing Criterion: 1.24

Zonal summary

Zone	Lumens	%Luminaire
0-30	140	28.6%
0-40	229	46.8%
0-60	403	82.4%
0-90	489	100.0%

Angle	Mean CP	Lumens
0	183	
5	181	
10	178	17
15	174	
20	167	49
25	160	
30	151	74
35	141	
40	129	89
45	117	
50	104	92
55	91	
60	75	82
65	57	
70	39	58
75	21	
80	6	25
85	1	
90	0	2

Single unit data

Height to lighted plane	Initial center beam foot-candles	Beam diameter (ft)*
5'	7	6.2'
6'	5	7.4'
7'	4	8.7'
8'	3	9.9'
9'	2	11.2'

* Beam diameter is where foot-candles drop to 50% of maximum.

Multiple unit data - RCR 2

Spacing on center	Initial center beam foot-candles	Watts per sq. ft.
5'	20.0	0.35
6'	13.0	0.23
7'	9.0	0.16
8'	8.0	0.14
9'	6.0	0.11

38' x 38' x 10' Room, Workplane 2.5' above floor, 80/50/20% Reflectances

Efficacy: 61.9lm/w
 Report²: STD211251NB-I

Coefficients of utilization

Ceiling	80%				70%		50%		30%		0%	
	70	50	30	10	50	10	50	10	50	10	0	
Wall	70	50	30	10	50	10	50	10	50	10	0	
RCR	Zonal cavity method - Effective floor reflectance = 20%											
Room Cavity Ratio	0	119	119	119	119	116	116	111	111	106	106	100
	1	110	105	101	98	103	96	99	93	95	90	86
	2	100	92	86	80	90	79	87	77	84	76	72
	3	91	81	73	67	80	66	77	65	74	64	61
	4	84	72	63	57	71	56	68	56	66	55	52
	5	77	64	56	49	63	49	61	48	59	48	45
	6	71	58	49	43	57	43	55	42	54	42	39
	7	66	53	44	38	52	38	50	37	49	37	35
	8	61	48	40	34	47	34	46	33	45	33	31
	9	57	44	36	30	43	30	42	30	41	30	28
	10	54	41	33	28	40	27	39	27	38	27	25

4RSLMZ10SCTUW • 4" Round, Field Selectable, Universal Voltage, White Finish

Candela Curve

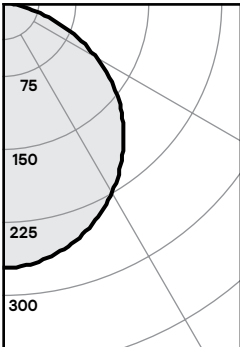

Fixture: 4RSLMZ10SCTUW

Output lumens: 732 lms
 Input watts: 10.9 W
 CRI: 90 (min)
 CCT¹: 2700K
 Beam Angle: 110°
 Spacing Criterion: 1.24

Zonal summary

Zone	Lumens	%Luminaire
0-30	209	28.6%
0-40	341	46.6%
0-60	600	82.0%
0-90	732	100.0%

Angle	Mean CP	Lumens
0	272	
5	270	
10	265	26
15	258	
20	249	73
25	237	
30	223	110
35	208	
40	191	132
45	173	
50	154	137
55	132	
60	108	122
65	84	
70	59	86
75	35	
80	14	40
85	2	
90	0	5

Single unit data

Height to lighted plane	Initial center beam foot-candles	Beam diameter (ft)*
5'	11	6.2'
6'	8	7.4'
7'	6	8.7'
8'	4	9.9'
9'	3	11.2'

* Beam diameter is where foot-candles drop to 50% of maximum.

Multiple unit data - RCR 2

Spacing on center	Initial center beam foot-candles	Watts per sq. ft.
5'	30.0	0.48
6'	20.0	0.32
7'	14.0	0.23
8'	12.0	0.19
9'	9.0	0.15

38' x 38' x 10' Room, Workplane 2.5' above floor, 80/50/20% Reflectances

Efficacy: 67.2lm/w
 Report²: STD211251NB-J

Coefficients of utilization

Ceiling	80%				70%		50%		30%		0%	
	70	50	30	10	50	10	50	10	50	10	0	
Wall	70	50	30	10	50	10	50	10	50	10	0	
RCR	Zonal cavity method - Effective floor reflectance = 20%											
Room Cavity Ratio	0	119	119	119	119	116	116	111	111	106	106	100
	1	109	105	101	97	103	96	98	93	95	90	85
	2	100	92	85	80	90	79	86	77	83	75	71
	3	91	81	73	67	79	66	76	65	74	64	60
	4	83	72	63	57	70	56	68	55	66	55	52
	5	77	64	55	49	63	48	61	48	59	47	45
	6	71	58	49	43	57	42	55	42	53	42	39
	7	66	52	44	38	52	37	50	37	49	37	35
	8	61	48	39	34	47	33	46	33	45	33	31
	9	57	44	36	30	43	30	42	30	41	30	28
	10	54	40	33	27	40	27	39	27	38	27	25

1. Correlated Color Temperature: within specs as defined in ANSI_NEMA_ANSI C78.377-2008: Specifications for the Chromaticity of Solid State Lighting Products.
 2. Tested using absolute photometry as specified in LM79: IESNA Approved Method for the Electrical and Photometric Measurements of Solid-State Lighting Products.

DL Downlight dual select

3", 4" & 6" Round

6RSLMZ10SCTUW • 6" Round, Field Selectable, Universal Voltage, White Finish

Candela Curve

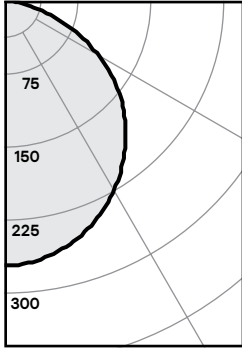

Fixture: **6RSLMZ10SCTUW**

Output lumens:	1063 lms
Input watts:	14.4 W
CRI:	90 (min)
CCT ¹ :	2700K
Beam Angle:	112°
Spacing Criterion:	1.26

Zonal summary

Zone	Lumens	%Luminaire
0-30	295	27.8%
0-40	482	45.3%
0-60	851	80.1%
0-90	1063	100.0%

Angle	Mean CP	Lumens
0	381	
5	379	
10	373	36
15	365	
20	353	103
25	338	
30	320	156
35	299	
40	276	187
45	251	
50	225	194
55	196	
60	166	175
65	133	
70	98	131
75	64	
80	33	68
85	7	
90	0	12

Single unit data

Height to lighted plane	Initial center beam foot-candles	Beam diameter (ft)*
5'	15	6.3'
6'	11	7.6'
7'	8	8.8'
8'	6	10.1'
9'	5	11.3'

* Beam diameter is where foot-candles drop to 50% of maximum.

Multiple unit data - RCR 2

Spacing on center	Initial center beam foot-candles	Watts per sq. ft.
5'	43.0	0.64
6'	28.0	0.42
7'	20.0	0.30
8'	17.0	0.25
9'	13.0	0.20

38' x 38' x 10' Room, Workplane 2.5' above floor, 80/50/20% Reflectances

Efficacy: 73.8lm/w
Report²: STD211251NB-K

Coefficients of utilization

Ceiling	80%				70%				50%				30%				0%				
Wall	70	50	30	10	50	10	50	10	50	10	50	10	50	10	50	10	50	10	50	10	
RCR	Zonal cavity method - Effective floor reflectance = 20%																				
Room Cavity Ratio	0	119	119	119	119	116	116	111	111	106	106	100	100	100	100	100	100	100	100	100	100
	1	109	104	100	97	102	95	98	92	94	89	84	84	84	84	84	84	84	84	84	84
	2	99	91	84	79	89	78	86	76	82	74	70	70	70	70	70	70	70	70	70	70
	3	90	80	72	65	78	65	75	64	73	63	59	59	59	59	59	59	59	59	59	59
	4	83	71	62	55	70	55	67	54	65	54	51	51	51	51	51	51	51	51	51	51
	5	76	63	54	48	62	47	60	47	58	46	44	44	44	44	44	44	44	44	44	44
	6	70	57	48	42	56	41	54	41	53	41	38	38	38	38	38	38	38	38	38	38
	7	65	52	43	37	51	37	49	36	48	36	34	34	34	34	34	34	34	34	34	34
	8	61	47	39	33	46	33	45	32	44	32	30	30	30	30	30	30	30	30	30	30
	9	57	43	35	29	43	29	41	29	40	29	27	27	27	27	27	27	27	27	27	27
	10	53	40	32	27	39	27	38	27	37	26	25	25	25	25	25	25	25	25	25	25

1. Correlated Color Temperature: within specs as defined in ANSI_NEMA_ANSI C78.377-2008: Specifications for the Chromaticity of Solid State Lighting Products.
2. Tested using absolute photometry as specified in LM79: IESNA Approved Method for the Electrical and Photometric Measurements of Solid-State Lighting Products.

