



The Advance Xtanium Sensor Ready (SR) LED driver can help reduce complexity and cost of light fixtures used in connected lighting systems for indoor lighting applications. It's D4i certified and features a standard-compliant digital interface to enable direct connection to compatible networked lighting control (NLC) solutions. The minimum dimming level has been improved to be as low as 1%. Advanced lighting control functionalities that ordinarily would require additional auxiliary component are integrated into this driver. The result is a simple, cost-effective lighting fixture that supports the most advanced smart lighting use cases.

### Specifications

Input Voltage (Vac)	Output Power (W)	Output Voltage (V)	Output Current (A)	Efficiency @ Max Load	Max Case Temp. (°C) Life/UL	Input Current (A)	Input Power (W)	THD @ Max Load (%)	Power Factor @ Max Load	Surge Protect (Ring Wave, KV)	Dimming	Dimming Range (%)	Min Dimming Current (mA)	Drive Type
347	50	10-54	0.1-1.4	88.0	75 / 85	0.17	58	<15	>0.95	3	DALI	1-100	4	CC

### Enclosure

Item	In(mm)	Tolerance (mm)
Overall length (A1)	14.17(359.8)	+/-0.5
Mounting Length (A2)	13.78(350)	+/-0.5
Case Length (A3)	11.87(301.5)	+/-0.5
Case Width (B1)	1.16(29.4)	+/-0.5
Case Height (C1)	1(25.4)	+/-1
Mounting Hole Diameter (D1)	0.31(7.9)	+/-0.3
Center of SimpleSet antenna (G1)	0.84(21.3)	+/-3

### Mechanical Diagram

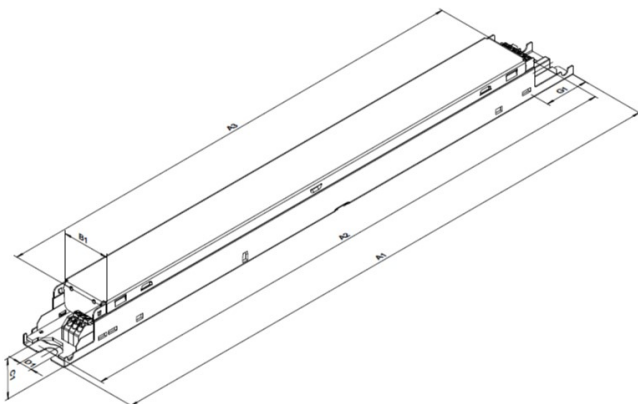

### Wiring Diagram

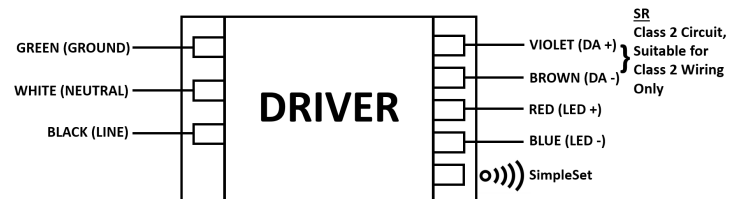

- Install in accordance with national and local electrical codes.
- The field-wiring leads or push-in terminals shall be fully enclosed.
- Use 18 AWG Solid Copper Wire Rated  $\geq 90$  °C.
- Strip Wire 3/8".
- For Class 2 Wiring, Use 20 AWG-16 AWG.
- Driver case must be grounded.

# XG050C140V054VPT1

## Features

- Standard-compliant (ANSI C137.4 and DiiA) digital interface
- Integrated DALI bus power supply (part 250)
- Memory bank 1 extension, energy monitoring and diagnostics (part 251, 252, 253)
- Energy metering and advanced diagnostics
- Continuous dimming down to 1%

## Benefits

- Enables interoperability with diverse wireless sensors/network systems
- Reduces cost and complexity of fixture by eliminating auxiliary components ordinarily required for powering sensors, switching fixture off and monitoring energy use
- Future proof through standard interface to any suitable sensor and ease of adjustable drive current

## Application

- Indoor linear applications such as troffers and pendants

## Logistical data

Specification item	Value
Product name	XG050C140V054VPT1
EOC	XG050C140V054VPT1
Logistic code 12NC	9290 027 69413
Product code	XG050C140V054VPT1M
GTIN	781087171301
Pieces per box	18
Weight	272 gram

All the specifications are typical and at  $T_{\text{ambient}} = 25^{\circ}\text{C}$  unless specified otherwise

## Electrical input data

Specification item	Value	Unit	Condition
Rated input voltage range	312...382	$V_{\text{ac}}$	Operating range
Rated input voltage	347	$V_{\text{ac}}$	
Rated input frequency	50...60	Hz	Performance range
Rated input current	0.17	A	@ rated output power @ rated input voltage
Rated input power	58.0	W	@ rated output power @ rated input voltage
Efficiency	88.0	%	@ rated output power @ rated input voltage

# XG050C140V054VPT1

## Electrical output data

Specification item	Value	Unit	Condition
Output voltage	10...54	V <sub>dc</sub>	Class 2 Output
Output voltage max.	60	V	Open Circuit Voltage
Output current	100...1400	mA	
Output current min programmable	100	mA	
Min output current	4	mA	
Output current tolerance ±	5	%	within performance window
Output current ripple LF	≤ 15	%	@ max lout
Output current ripple HF	≤ 4	%	@ frequency range 60Hz-3KHz
Output P <sub>st</sub> <sup>LM</sup>	≤ 1.0		Flicker in compliance per NEMA 77
Output SVM	≤ 1.0		Flicker in compliance per NEMA 77
Output power	0.1...50.0	W	
Minimum performance output power	20	W	Power factor > 0.9 and THD < 20%

## Control interfaces

Specification item	Value	Unit	Condition
Control method	DALI		
Dimming range	1...100	%	Default range
SR Power Supply max voltage.	20	V	
SR Power Supply max current source	60	mA	
SR Power Supply min voltage	12	V	
SR Power Supply min current source	52	mA	
Communication Protocol	DALI-2, D4i, ANSI C137.4		

## Isolation

U = Max. input voltage

Isolation per UL-8750	Input	Output	0-10V	Enclosure
Input	-	2U + 1kVac	2U + 1kVac	2U + 1kVac
Output	2U + 1kVac	-	2U + 1kVac	500Vac
0-10V	2U + 1kVac	2U + 1kVac	-	2U + 1kVac
Enclosure	2U + 1kVac	500Vac	2U + 1kVac	-

## Operational temperatures and humidity

Specification item	Value	Unit	Condition
Ambient temperature	-20...+50	°C	Higher ambient temperature allowed as long as T <sub>case</sub> -max is not exceeded
T <sub>case</sub> -UL	85	°C	Max. temperature measured at T <sub>case</sub> -point
T <sub>case</sub> -life	75	°C	Meet 50K hour life at T <sub>c</sub> life measured at T <sub>c</sub> -point

# XG050C140V054VPT1

## Lifetime

Specification item	Value	Unit	Condition
Driver lifetime	50,000	hours	Measured temperature at Tcase-point is Tcase-life

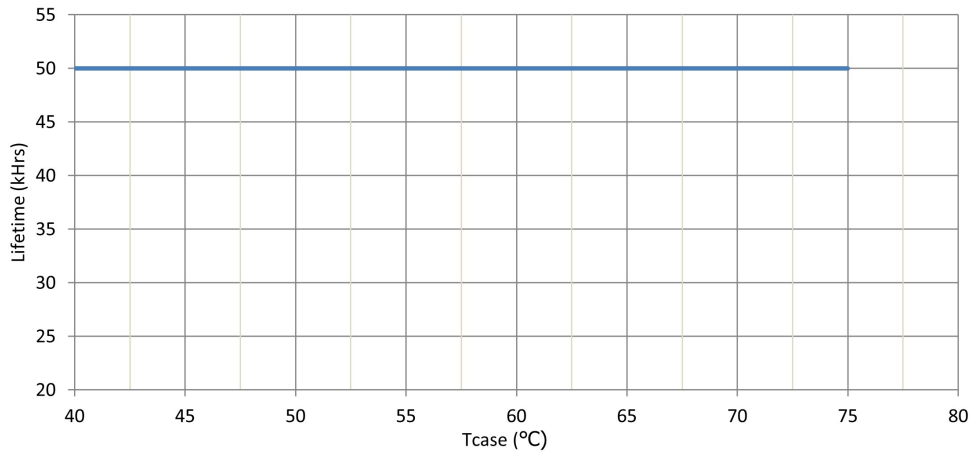

Maximum failures = 10%

## Programmable features

Specification item	Available	Default setting	Condition
Set Adjustable Output Current (AOC)	NFC, SimpleSet	1400 mA	
Adjustable Light Output (ALO)	Yes		
Constant Light Output (CLO)	Yes		
Min Dim Level (%)	Yes		
OEM Write Protection (OWP)	Yes		
DALI Power Supply (DALI part 250)	Yes		
Luminaire Info (DALI part 251)	Yes		
Luminaire maintenance (DALI part 253)	Yes		

## Non-programmable features

Specification item	Value	Condition
Open load protection	Yes	Automatic recovering
Short circuit protection	Yes	Automatic recovering
Over power protection	Yes	Automatic recovering
Overtemperature protection	Yes	Automatic recovering

# XG050C140V054VPT1

## Inrush current

Specification item	Value	Unit	Condition
Inrush current	9.54	A	Input voltage 347V
Inrush peak width	12.12	$\mu$ s	Input voltage 347V, measured at 10% height

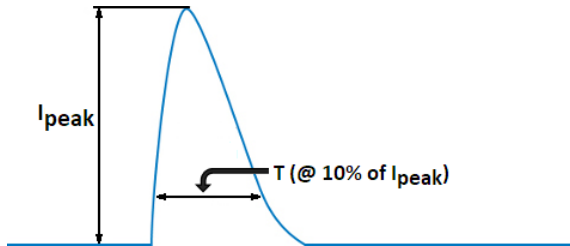

## Surge immunity

Specification item	Value	Unit	Condition
Mains surge immunity (diff. mode)	6	kV	ANSI Surge Type 100kHz Ring Wave (w/t 30 ohm)
Mains surge immunity (comm. mode)	3	kV	ANSI Surge Type 100kHz Ring Wave (w/t 30 ohm)

## Approbation

Specification item	Value
Approval Marks / Agency Approbations	D4i / RoHS / SR / UL Class P / UL Listed US & Can
EMI standards	FCC Title 47 Part 15; Class A
Environmental protection rating	UL damp & dry
Audible Noise	<24dB Class A

# XG050C140V054VPT1

## Graphs

### Operating window

---

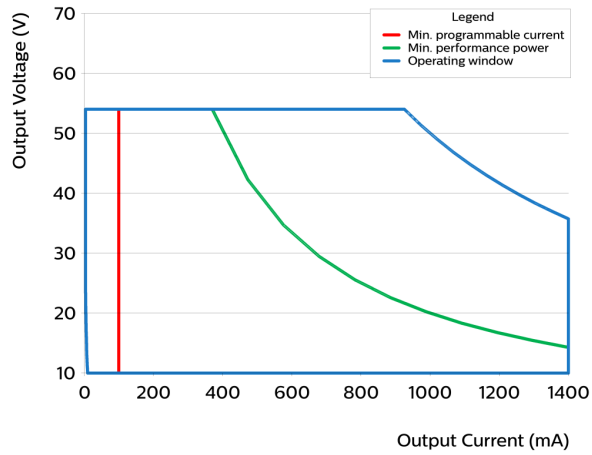

- Factory default output current is 1.4A.
- To get a 100% to 1% dimming range, the output current setting through AOC should be  $\geq 0.4A$ .
- Factory default minimum dimming is 1%. This can be adjusted between 1% and 100% using Advance MultiOne.

### Over Temperature Protection

---

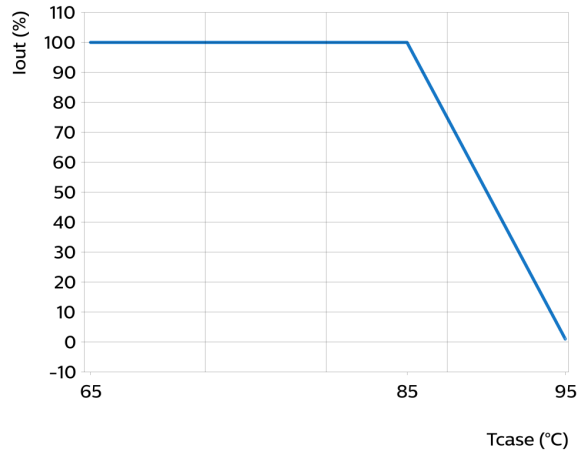

# XG050C140V054VPT1

## Power factor versus output power

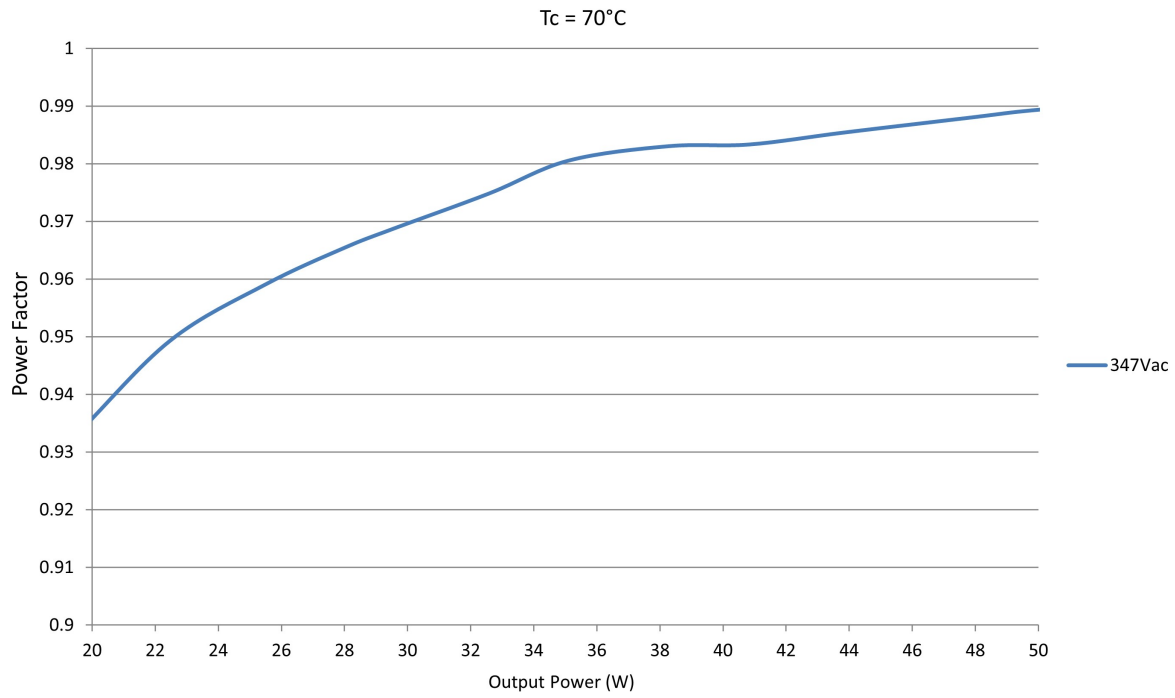

## THD versus output power

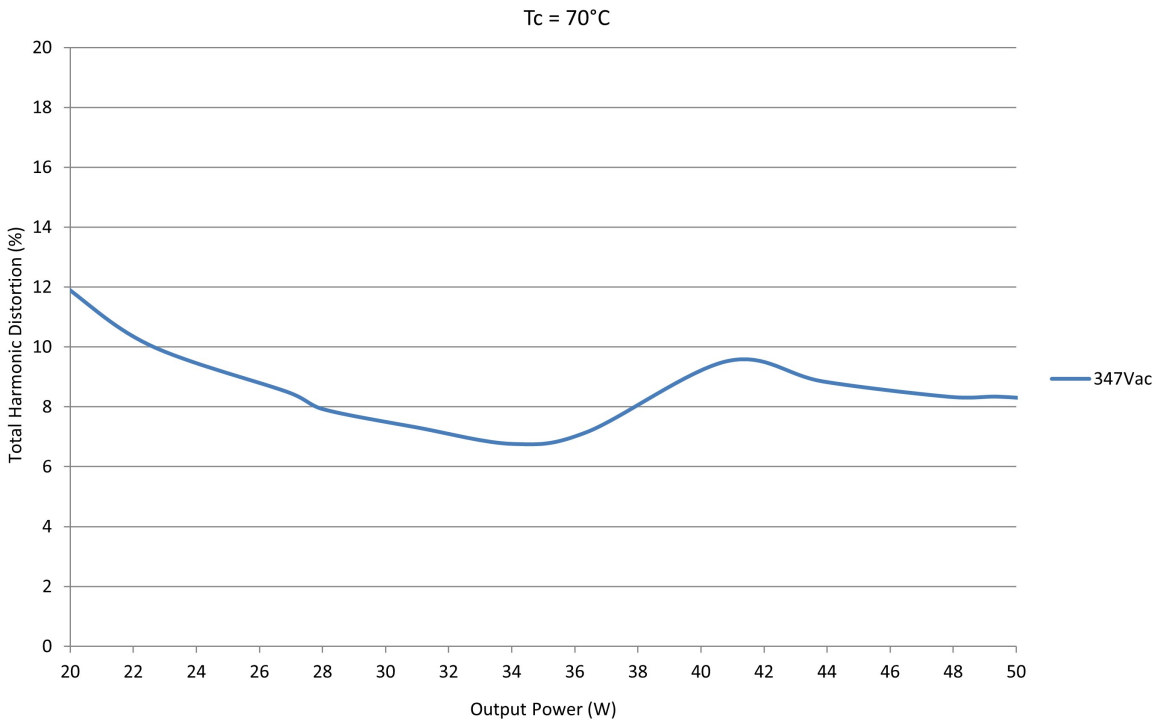

# XG050C140V054VPT1

Efficiency as function of  $V_{out}$

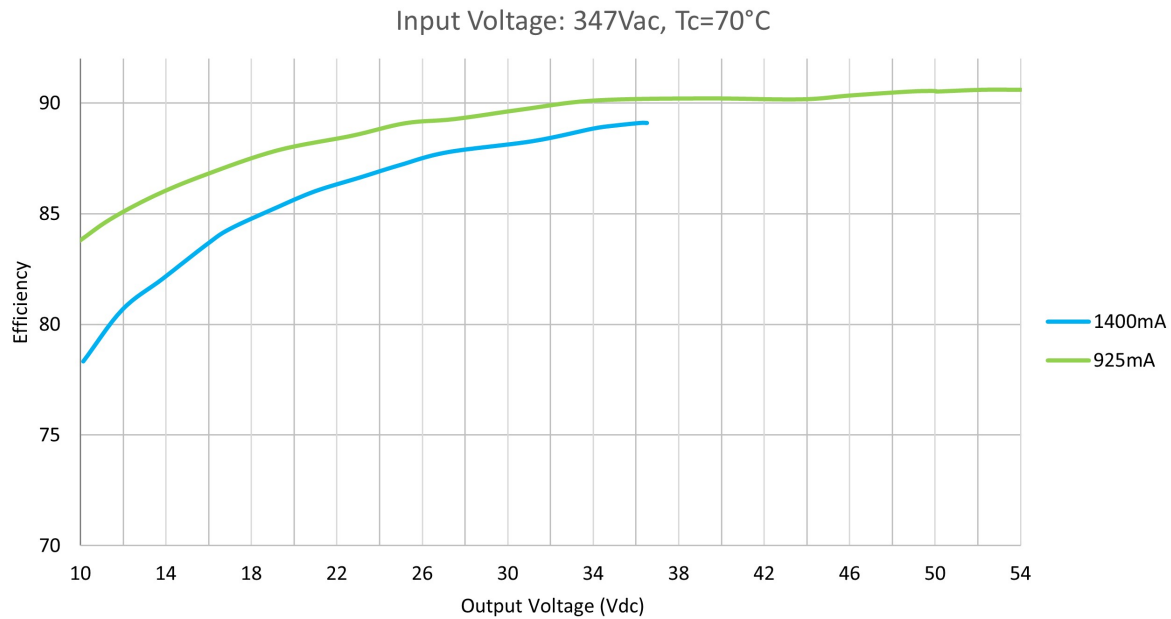

## Appendix

### DALI Dimming Characteristics

Dimming is accomplished through the 2-wire DALI connection to the sensor. DALI standard IEC62386\_102 Edition 2 defines the logarithmic dimming curve. DALI standard IEC62386\_107 Edition 1 defines the linear dimming curve as well as the command for switching between logarithmic and linear curves (Default=Logarithmic).

DALI Logarithmic Dimming Curve

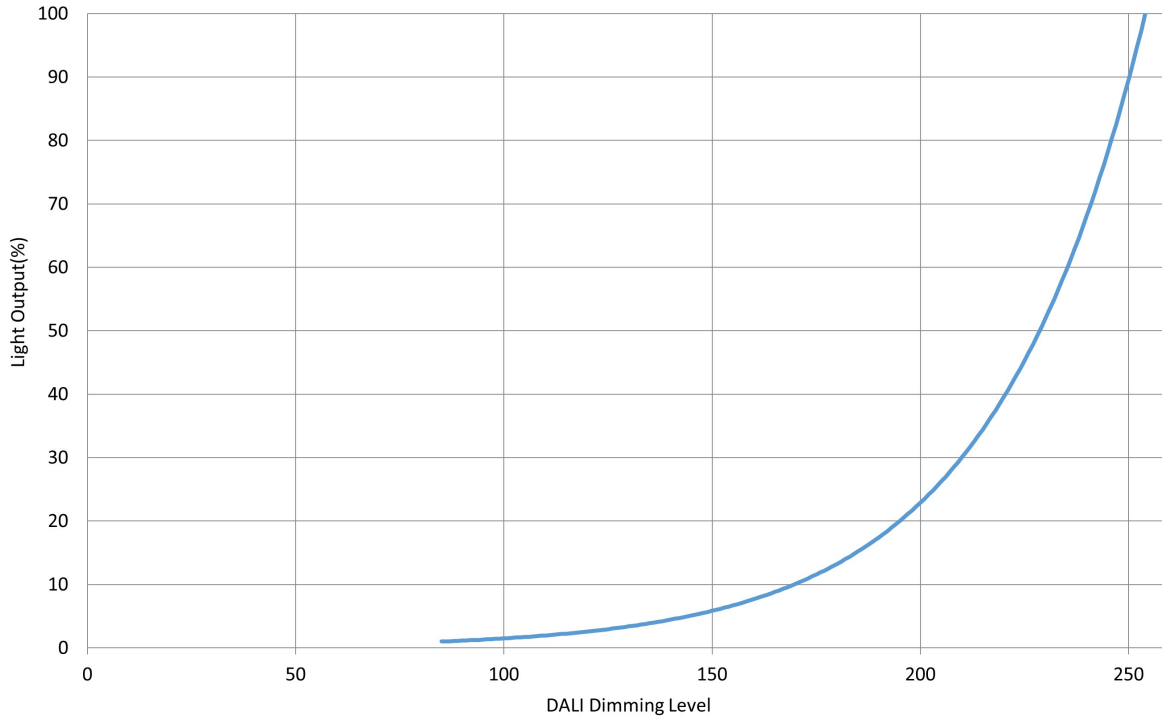

DALI Linear Dimming Curve

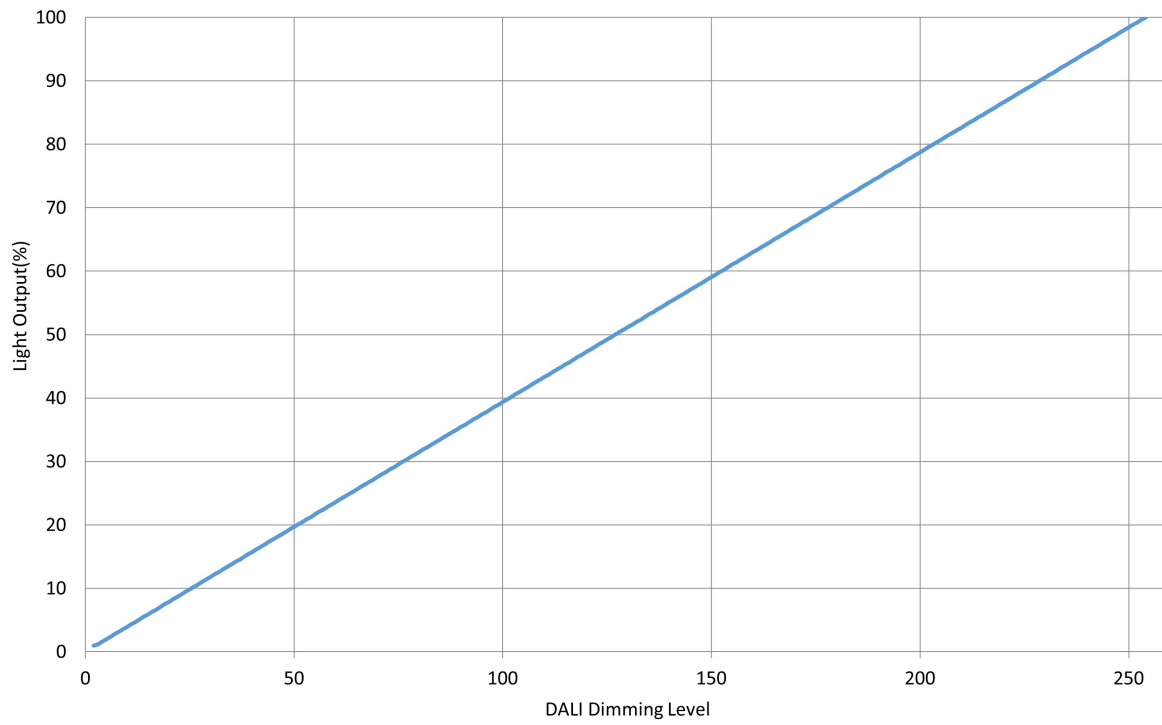

### DALI Power Supply Characteristics (Typical)

