



BDP260 LED74-4S/830 II
DW10 62P

912300024269



TownTune Central Post-Top, Urban road & street light, 56 W, 5402 lm, 3000 K, CRI80, Distribution wide 10, Safety class II, IP66, STD

Urban road & street light, Aluminum die cast, Gray, Post-top for diameter 62 mm, Power supply unit (On/Off), 5402 lm, 56 W, 96 lm/W, 3000 K, (0.410, 0.390) SDCM <5, CRI80, Distribution wide 10, IP66 | Dust penetration-protected, jet-proof, IK10 | 20 J vandal-resistant, Safety class II, Standard surge protection level, Internal connector

General Information

Lamp family code	LED74 [LED module 7400 lm]
Light source replaceable	Yes
Number of gear units	1 unit
Driver included	Yes
Light source engine type	LED
Service tag	Yes
Lighting Technology	LED
Value ladder	Performance
Warranty period	5 years

Light Technical

Upward light output ratio	0
Luminous Flux	5,402 lm
Correlated Color Temperature (Nom)	3000 K
Luminous Efficacy (rated) (Nom)	96 lm/W
Color rendering index (CRI)	80
Light source color	830 warm white
Luminaire light beam spread	7° - 52° × 150°
Optic type outdoor	Distribution wide 10
Effective projected area	0.042 m ²

Operating and Electrical

Input Voltage	220 to 240 V
Line Frequency	50 to 60 Hz
Inrush current	43 A
Inrush time	0.26 ms
Power Consumption	56 W
Power Factor (Fraction)	0.98
Connection	Internal connector
Cable	-
Number of products on MCB of 16 A type B	10
Protection class IEC	Safety class II
Surge Protection (Common/Differential)	Standard surge protection level

Controls and Dimming

Dimmable	No
Driver/power unit/transformer	Power supply unit (On/Off)
Control interface	-
Constant light output	No
DALI Standard	DALI-2™
Maximum dim level	10%

Mechanical and Housing

Housing Material	Aluminum die cast
Reflector material	Acrylate
Optic material	Polymethyl methacrylate
Optical cover material	Polymethyl methacrylate
Fixation material	Aluminum
Housing Color	Gray
Mounting device	Post-top for diameter 62 mm
Optical cover shape	Convex lens
Optical cover finish	Clear
Overall height	187 mm
Overall diameter	477 mm
Ingress protection code	IP66 [Dust penetration-protected, jet-proof]
Mech. impact protection code	IK10 [20 J vandal-resistant]
Standard tilt angle posttop	0°
Standard tilt angle side entry	-
Optical cover type	Polycarbonate bowl/cover UV-resistant
Net Weight (Piece)	6.800 kg

Approval and Application

Flammability mark	For mounting on normally flammable surfaces
CE mark	Yes
ENEC mark	ENEC mark
Photobiological risk	Photobiological risk group 1 @200mm to EN62778
EU RoHS compliant	Yes
Performance ambient temperature Tq	25 °C
Remarks	* At extreme ambient temperatures the luminaire might automatically dim down to protect components
Ambient temperature range	-40 to +50 °C

Initial Performance (IEC Compliant)

Luminous flux tolerance	+/-7%
Initial chromaticity	(0.410, 0.390) SDCM <5
Power consumption tolerance	+/-10%
Init. Color Rendering Index Tolerance	+/-2
Standard Deviation of Colour Matching (McAdam ellipse)	SDCM≤5

Over Time Performance (IEC Compliant)

Driver failure rate at 5000 h	0.5 %
Control gear failure rate at median useful life 100000 h	10 %
Lumen maintenance (EN-IEC 62722-2-1) at median useful life* 100000 h	L96

Sustainability Data

Sustainability rating	Unclassified
Repair class	Repair Class B, the driver and light source of this luminaire can be replaced by a service technician. Parts and documentation are available for an extended period of time.

Embedded carbon (A1-A3)	58.7 kg CO ₂ e
Product non-virgin material ratio	55.2 %
Recyclable content ratio of the finished product	55.2 %
GWP total B6 (kg CO ₂ eq) Declared Unit	Please calculate using your local energy mix value: Power Declared Unit (kW) * Service life (hrs) Declared Unit * Energy mix (kg CO ₂ eq / kwh)
GWP total B6 (kg CO ₂ eq) Functional Unit	Please calculate using your local energy mix value: Power Declared Unit (kW) * 1000 (lm) /lumen output (lm) Declared Unit * 35000 (hrs) * Energy mix (kg CO ₂ eq / kwh)
Non-virgin material ratio of the packaging	Cardboard > 80% recycled
Packaging Recyclable content ratio	Cardboard recycling rate > 80%
Packaging Material	Cardboard

Product Data

Order product name	BDP260 LED74-4S/830 II DW10 62P
Full product name	BDP260 LED74-4S/830 II DW10 62P
Full product code	871869986506100
Order code	86506100
Material Nr. (12NC)	912300024269
Numerator - Quantity Per Pack	1
EAN/UPC - Product/Case	8718699865061
Numerator - Packs per outer box	1
EAN/UPC - Case	8718699865061
Product family code	BDP260 [TOWNTUNE CENTRAL POST-TOP]

Dimensional drawing

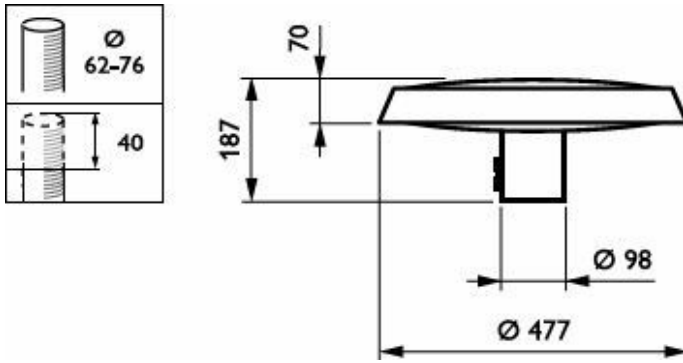

Polar normal diagrams

