



GreenSpace G6

DN392B LED18/840 PSD D150 AL GCG2HE

GreenSpace G6, 13.4 W, 1800 lm, 4000 K, DALI, Facetted reflector, Matte, IP20 | Finger-protected

Philips GreenSpace G6 builds on the GreenSpace family's reputation for superb performance, extremely low energy use, and high visual comfort. This next generation of reliable LED downlights comes in a highly-compact design with a deep, recessed architecture and increased reflector depth to highlight the smallest of details. GreenSpace G6 is also a shining example of versatility. This energy-saving LED downlight is available in a comprehensive range of configurations from 600 to 3,550 lumen, with the option to choose fixed, dimmable, or Interact Ready variants. This makes GreenSpace G6 the perfect 'mix and match' solution for potentially broad and extended applications that require different lighting ambiances, with one cohesive luminaire look and feel.

Product data

General Information		Operating and Electrical	
Number of gear units	-	Color rendering index (CRI)	≥80
Gear	-	Number of light sources	48
Driver included	No	Beam angle of light source	10 or 40 degree(s)
Light source engine type	LED	Light source color	840 neutral white
Service tag	Yes	Optic type	Facetted reflector
Value ladder	Performance	Unified glare rating CEN	Not applicable
Warranty period	3 years		
Light Technical		Input Voltage	220 to 240 V
Luminous Flux	1,800 lm	Line Frequency	50 or 60 Hz
Correlated Color Temperature (Nom)	4000 K	Inrush current	16.5 A
Luminous Efficacy (rated) (Nom)	130 lm/W	Inrush time	177 ms
		Power Consumption	13.4 W

GreenSpace G6

Power Factor (Fraction)	0.9
Connection	2 Push-in connector 2-pole
Cable	-
Number of products on MCB of 16 A type B	36
Suitable for random switching	No
Protection class IEC	Safety class II

Controls and Dimming

Dimmable	DALI
Control interface	DALI
Maximum dim level	1%

Mechanical and Housing

Housing Material	Aluminum die-cast
Reflector material	Polycarbonate
Optic material	Polycarbonate
Optical cover material	Polycarbonate
Housing Color	Aluminum and RAL (to be defined)
Mounting device	Frame for recessed mounting
Optical cover finish	Matte
Overall height	80 mm
Overall diameter	162 mm
Ingress protection code	IP20 [Finger-protected]
Mech. impact protection code	IK03 [0.3 J]
Optical cover type	Polycarbonate Diffuser
Net Weight (Piece)	0.490 kg

Approval and Application

Glow-wire test	Temperature 650 °C, duration 5 s
Flammability mark	-
CE mark	Yes
ENEC mark	-
Photobiological risk	Photobiological risk group 1 @200mm to EN62778
EU RoHS compliant	Yes
Performance ambient temperature Tq	25 °C
Ambient temperature range	-20 to +40 °C

Initial Performance (IEC Compliant)

Luminous flux tolerance	-10% / +10%
Initial chromaticity	5
Power consumption tolerance	+/-10%

Product Data

Order product name	DN392B LED18/840 PSD D150 AL GCG2HE
Full product name	DN392B LED18/840 PSD D150 AL GCG2HE
Order code	911401576244
Material Nr. (12NC)	911401576244
Numerator - Quantity Per Pack	1
Numerator - Packs per outer box	1

Dimensional drawing

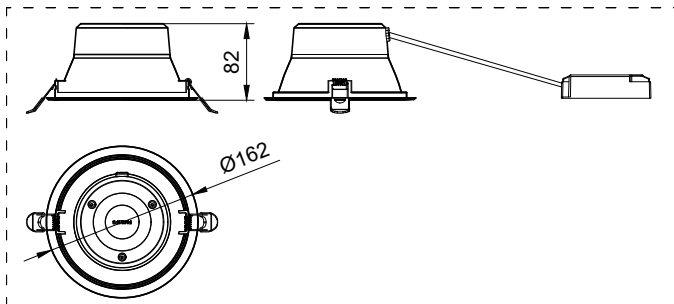

GreenSpace G6

