



# GreenPerform Highbay G5

## BY698X G5 LED150/NW L1W PIR WB GM L3m

GreenPerform Highbay G5, 88 W, 15000 lm, 4000 K, Internal (no external connection), 85°

The GreenPerform Highbay G5 continues the GreenPerform family's enviable reputation for reliable performance. Not only does it deliver leading system efficacy and extended long-term quality, it also promises Unified Glare Rating (UGR) control with compact dimensions. GreenPerform Highbay G5 is also fully compatible with IoT software such as Interact, which is a scalable, future-proof control system. The family also has a series that supports cold room applications with 100% humidity and no condensation. All benefits that make this robust, optimized, and versatile family suitable for almost all industrial applications.

### Product data

General Information	
Number of gear units	1 unit
Gear	-
Driver included	Yes
Light source engine type	LED
Value ladder	Performance
Warranty period	5 years

Light Technical	
Luminous Flux	15,000 lm
Correlated Color Temperature (Nom)	4000 K
Luminous Efficacy (rated) (Nom)	170 lm/W
Color rendering index (CRI)	80

Number of light sources	1
Beam angle of light source	115 degree(s)
Light source color	840 neutral white
Optic type	Wide beam
Luminaire light beam spread	85°
Unified glare rating CEN	25
Effective projected area	0 m <sup>2</sup>

Operating and Electrical	
Input Voltage	220 to 240 V
Line Frequency	50 or 60 Hz
Inrush current	32.6 A
Inrush time	0.666 ms

## GreenPerform Highbay G5

Power Consumption	88 W
Power Factor (Fraction)	0.95
Connection	Flying leads/wires
Cable	Cable 3.0 m without plug
Number of products on MCB of 16 A type B 6	
Suitable for random switching	Yes
Protection class IEC	Safety class I

### Controls and Dimming

Dimmable	Wireless Dim - Do not use with dimmer
Control interface	Internal (no external connection)
Maximum dim level	0% (digital)

### Mechanical and Housing

Housing Material	Aluminum die-cast
Reflector material	-
Optic material	Polycarbonate
Optical cover material	Polycarbonate
Housing Color	Grey
Mounting device	Suspension set simple, standard
Optical cover finish	Clear
Overall length	435 mm
Overall width	290 mm
Overall height	100 mm
Dimensions (Height x Width x Depth)	100 x 290 x 435 mm
Ingress protection code	IP65 [Dust penetration-protected, jet-proof]
Mech. impact protection code	IK03 [0.3 J]
Optical cover type	Clear dome
Net Weight (Piece)	2.290 kg

### Approval and Application

Glow-wire test	Temperature 750 °C, duration 30 s
Flammability mark	For mounting on normally flammable surfaces

CE mark	Yes
ENEC mark	-
Photobiological risk	Photobiological risk group 1 @200mm to EN62778
Photobiological risk specification	0.2 m
EU RoHS compliant	Yes
Performance ambient temperature Tq	35 °C
Ambient temperature range	-30 to +50 °C

### UV

UV-C radiation	0 W
UV-C irradiance defined at 0.2m	0 mW/m <sup>2</sup>

### Initial Performance (IEC Compliant)

Luminous flux tolerance	+/-10%
Initial chromaticity	(0.386, 0.384) SDCM<5
Power consumption tolerance	+/-10%

### Product Data

Order product name	BY698X G5 LED150/NW L1W PIR WB GM L3m
Full product name	BY698X G5 LED150/NW L1W PIR WB GM L3m
Full product code	872110330820700
Order code	911401552245
Material Nr. (12NC)	911401552245
Numerator - Quantity Per Pack	1
EAN/UPC - Product/Case	8721103308207
Numerator - Packs per outer box	1
EAN/UPC - Case	8721103308207

## Dimensional drawing

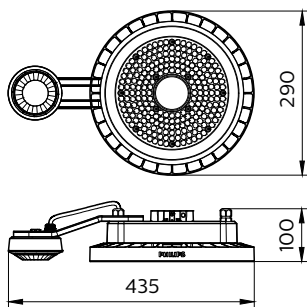

## GreenPerform Highbay G5

