



GreenSpace G6

DN391B LED12/865 PSU D100 WH GCG2HE

GreenSpace G6, 9.8 W, 1250 lm, 6500 K, White reflector and opal cover, Matte, IP20 | Finger-protected

Philips GreenSpace G6 builds on the GreenSpace family's reputation for superb performance, extremely low energy use, and high visual comfort. This next generation of reliable LED downlights comes in a highly-compact design with a deep, recessed architecture and increased reflector depth to highlight the smallest of details. GreenSpace G6 is also a shining example of versatility. This energy-saving LED downlight is available in a comprehensive range of configurations from 600 to 3,550 lumen, with the option to choose fixed, dimmable, or Interact Ready variants. This makes GreenSpace G6 the perfect 'mix and match' solution for potentially broad and extended applications that require different lighting ambiances, with one cohesive luminaire look and feel.

Product data

General Information		Color rendering index (CRI)	
Number of gear units	-		>80
Gear	-	Number of light sources	1
Driver included	Yes	Light source color	865 cool daylight
Light source engine type	LED	Optic type	White reflector and opal cover
Service tag	Yes	Unified glare rating CEN	26
Value ladder	Performance	Operating and Electrical	
Warranty period	3 years	Input Voltage	220 to 240 V
Light Technical		Line Frequency	50 or 60 Hz
Luminous Flux	1,250 lm	Inrush current	14 A
Correlated Color Temperature (Nom)	6500 K	Inrush time	0.01 ms
Luminous Efficacy (rated) (Nom)	130 lm/W	Power Consumption	9.8 W
		Power Factor (Fraction)	0.9

GreenSpace G6

Connection	Flying leads/wires
Cable	2x0.75mm ² Cable 0.2 m without plug
Number of products on MCB of 16 A type B 204	
Suitable for random switching	No
Protection class IEC	Safety class II

Controls and Dimming

Dimmable	No
Control interface	-
Maximum dim level	Not applicable

Mechanical and Housing

Housing Material	Aluminum die-cast
Reflector material	Polycarbonate
Optic material	Polycarbonate
Optical cover material	Polycarbonate
Housing Color	Aluminum
Mounting device	Frame for recessed mounting
Optical cover finish	Matte
Overall height	68 mm
Overall diameter	120 mm
Ingress protection code	IP20 [Finger-protected]
Mech. impact protection code	IK03 [0.3 J]
Optical cover type	Polycarbonate Diffuser
Net Weight (Piece)	0.240 kg

Approval and Application

Glow-wire test	Temperature 650 °C, duration 5 s
Flammability mark	-
CE mark	Yes
ENEC mark	-
Photobiological risk	Photobiological risk group 1 @200mm to EN62778
EU RoHS compliant	Yes
Performance ambient temperature Tq	25 °C
Ambient temperature range	-20 to +40 °C

Initial Performance (IEC Compliant)

Luminous flux tolerance	+/-10%
Initial chromaticity	5
Power consumption tolerance	+/-10%

Product Data

Order product name	DN391B LED12/865 PSU D100 WH GCG2HE
Full product name	DN391B LED12/865 PSU D100 WH GCG2HE
Order code	911401535544
Material Nr. (12NC)	911401535544
Numerator - Quantity Per Pack	1
Numerator - Packs per outer box	4

Dimensional drawing

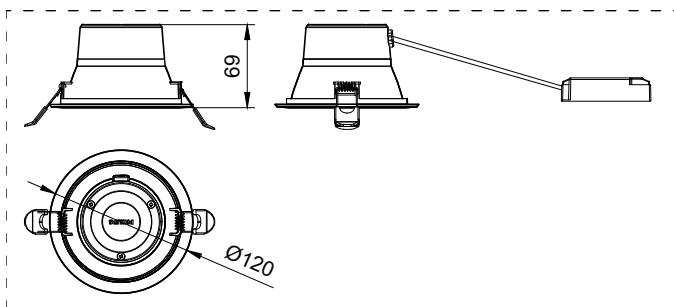

GreenSpace G6

