



GreenSpace Surface-mounted

SM294C LED40/830 PSU BK

LED, 36 W, Power supply unit (On/Off), High-gloss mirror, Reflector, 60°

Philips GreenSpace Surface-mounted LED Downlight delivers a superior LED alternative that's up to 66% more energy efficient than the conventional downlight retrofits. Blending seamlessly into its environment, GreenSpace Surface-mounted LED Downlight mimics the form of conventional recessed downlights minus the associated high energy and maintenance costs. Philips GreenSpace Surface-mounted LED Downlight is also ideal for all commercial lighting applications as well as public indoor space where there is limited space in the ceiling.

Product data

General Information		Light source color	
Light source replaceable	No	Light source color	830 warm white
Number of gear units	1 unit	Optic type	High-gloss mirror
Driver included	Yes	Luminaire light beam spread	60°
Light source engine type	LED	Operating and Electrical	
Service tag	Yes	Input Voltage	220 to 240 V
Value ladder	Performance	Line Frequency	50 or 60 Hz
Warranty period	3 years	Inrush current	25 A
		Inrush time	0.202 ms
		Power Consumption	36 W
		Power Factor (Fraction)	0.9
		Number of products on MCB of 16 A type B	24
		Suitable for random switching	No
Light Technical			
Luminous Flux	3,800 lm		
Correlated Color Temperature (Nom)	3000 K		
Luminous Efficacy (rated) (Nom)	105 lm/W		
Color rendering index (CRI)	>80		

GreenSpace Surface-mounted

Protection class IEC	Safety class I
----------------------	----------------

Controls and Dimming

Dimmable	No
Driver/power unit/transformer	Power supply unit (On/Off)
Control interface	-
Constant light output	No

Mechanical and Housing

Housing Material	Aluminum die cast
Reflector material	Aluminum
Optic material	Aluminum
Optical cover material	-
Housing Color	Black
Optical cover finish	-
Overall length	0 mm
Overall width	0 mm
Overall height	239 mm
Overall diameter	200 mm
Dimensions (Height x Width x Depth)	239 x 0 x 0 mm
Ingress protection code	IP65 [Dust penetration-protected, jet-proof]
Mech. impact protection code	IK02 [0.2 J standard]
Optical cover type	Reflector
Net Weight (Piece)	0.800 kg

Approval and Application

Glow-wire test	Temperature 750 °C, duration 5 s
----------------	----------------------------------

Dimensional drawing

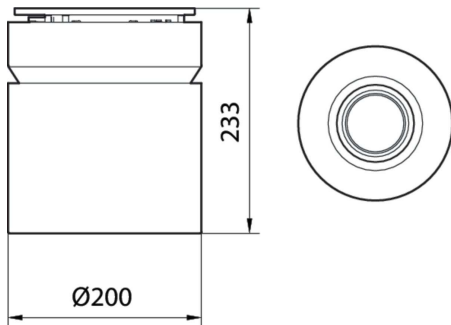

CE mark	Yes
Ambient temperature range	-20 to +40 °C

Initial Performance (IEC Compliant)

Luminous flux tolerance	+/-10%
Initial chromaticity	(0.44, 0.40) SDCM <5
Power consumption tolerance	+/-10%

Over Time Performance (IEC Compliant)

Driver failure rate at 5000 h	1.00 %
Median useful life L70B50	50,000 hour(s)
Median useful life L80B50	40,000 hour(s)
Median useful life L90B50	20,000 hour(s)

Product Data

Order product name	SM294C LED40/830 PSU BK
Full product name	SM294C LED40/830 PSU BK
Full product code	911401510331
Order code	01510331
Material Nr. (12NC)	911401510331
Numerator - Quantity Per Pack	1
Numerator - Packs per outer box	1

GreenSpace Surface-mounted

