



# GreenSpace Surface-mounted

## SM294C LED40/865 PSU WH

LED, 36 W, Power supply unit (On/Off), High-gloss mirror, Reflector, 60°

Philips GreenSpace Surface-mounted LED Downlight delivers a superior LED alternative that's up to 66% more energy efficient than the conventional downlight retrofits. Blending seamlessly into its environment, GreenSpace Surface-mounted LED Downlight mimics the form of conventional recessed downlights minus the associated high energy and maintenance costs. Philips GreenSpace Surface-mounted LED Downlight is also ideal for all commercial lighting applications as well as public indoor space where there is limited space in the ceiling.

### Product data

General Information		Light source color	
Light source replaceable	No	Light source color	865 cool daylight
Number of gear units	1 unit	Optic type	High-gloss mirror
Driver included	Yes	Luminaire light beam spread	60°
Light source engine type	LED	Operating and Electrical	
Service tag	Yes	Input Voltage	220 to 240 V
Value ladder	Performance	Line Frequency	50 or 60 Hz
Warranty period	3 years	Inrush current	25 A
		Inrush time	0.202 ms
		Power Consumption	36 W
		Power Factor (Fraction)	0.9
		Number of products on MCB of 16 A type B	24
		Suitable for random switching	No
Light Technical			
Luminous Flux	3,800 lm		
Correlated Color Temperature (Nom)	6500 K		
Luminous Efficacy (rated) (Nom)	105 lm/W		
Color rendering index (CRI)	>80		

## GreenSpace Surface-mounted

Protection class IEC	Safety class I
----------------------	----------------

### Controls and Dimming

Dimmable	No
Driver/power unit/transformer	Power supply unit (On/Off)
Control interface	-
Constant light output	No

### Mechanical and Housing

Housing Material	Aluminum die cast
Reflector material	Aluminum
Optic material	Aluminum
Optical cover material	-
Housing Color	White
Optical cover finish	-
Overall length	0 mm
Overall width	0 mm
Overall height	239 mm
Overall diameter	200 mm
Dimensions (Height x Width x Depth)	239 x 0 x 0 mm
Ingress protection code	IP65 [Dust penetration-protected, jet-proof]
Mech. impact protection code	IK02 [0.2 J standard]
Optical cover type	Reflector
Net Weight (Piece)	0.800 kg

### Approval and Application

Glow-wire test	Temperature 750 °C, duration 5 s
----------------	----------------------------------

### Dimensional drawing

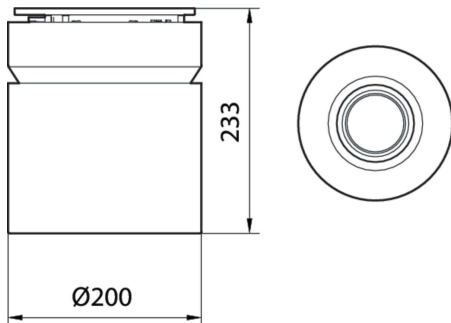

CE mark	Yes
Ambient temperature range	-20 to +40 °C

### Initial Performance (IEC Compliant)

Luminous flux tolerance	+/-10%
Initial chromaticity	(0.31, 0.32) SDCM <5
Power consumption tolerance	+/-10%

### Over Time Performance (IEC Compliant)

Driver failure rate at 5000 h	1.00 %
Median useful life L70B50	50,000 hour(s)
Median useful life L80B50	40,000 hour(s)
Median useful life L90B50	20,000 hour(s)

### Product Data

Order product name	SM294C LED40/865 PSU WH
Full product name	SM294C LED40/865 PSU WH
Full product code	911401510231
Order code	01510231
Material Nr. (12NC)	911401510231
Numerator - Quantity Per Pack	1
Numerator - Packs per outer box	1

## GreenSpace Surface-mounted

