



GreenSpace G6

DN392X LED17/9TNW P15PSD D150 WH WP G2

GreenSpace G6, 15 W, 1700 lm, Tunable white 2700-6500 K, DALI, White reflector and opal cover, Matte, IP54 | Dust accumulation-protected, splash-proof

Philips GreenSpace G6 builds on the GreenSpace family's reputation for superb performance, extremely low energy use, and high visual comfort. This next generation of reliable LED downlights comes in a highly-compact design with a deep, recessed architecture and increased reflector depth to highlight the smallest of details. GreenSpace G6 is also a shining example of versatility. This energy-saving LED downlight is available in a comprehensive range of configurations from 600 to 3,550 lumen, with the option to choose fixed, dimmable, or Interact Ready variants. This makes GreenSpace G6 the perfect 'mix and match' solution for potentially broad and extended applications that require different lighting ambiances, with one cohesive luminaire look and feel.

Product data

General Information		Operating and Electrical	
Number of gear units	1 unit	Number of light sources	48
Gear	-	Beam angle of light source	- degree(s)
Driver included	Yes	Light source color	Tunable white
Light source engine type	LED	Optic type	White reflector and opal cover
Value ladder	Performance	Luminaire light beam spread	83°
Light Technical		Unified glare rating CEN	24
Luminous Flux	1,700 lm	Input Voltage	220 to 240 V
Correlated Color Temperature (Nom)	Tunable white 2700-6500 K	Line Frequency	50 or 60 Hz
Luminous Efficacy (rated) (Nom)	120 lm/W	Inrush current	4.69 A
Color rendering index (CRI)	≥90	Power Consumption	15 W

GreenSpace G6

Power Factor (Fraction)	0.9
Connection	Flying leads/wires
Cable	Cable 0.2 m without plug
Number of products on MCB of 16 A type B	84
Suitable for random switching	Yes
Protection class IEC	Safety class II

Controls and Dimming

Dimmable	DALI
Control interface	DALI
Maximum dim level	1%

Mechanical and Housing

Housing Material	Aluminum die-cast
Reflector material	Polycarbonate
Optic material	Polycarbonate
Optical cover material	Polycarbonate
Housing Color	Black
Mounting device	Frame for recessed mounting
Optical cover finish	Matte
Overall height	80 mm
Overall diameter	162 mm
Ingress protection code	IP54 [Dust accumulation-protected, splash-proof]
Mech. impact protection code	IK03 [0.35 J reinforced]
Optical cover type	Polycarbonate Diffuser
Net Weight (Piece)	0.490 kg

Approval and Application

Glow-wire test	Temperature 650 °C, duration 5 s
CE mark	Yes
ENEC mark	-
Photobiological risk	Photobiological risk group 1 @200mm to EN62778
EU RoHS compliant	Yes
Performance ambient temperature Tq	25 °C
Ambient temperature range	-20 to +40 °C

Initial Performance (IEC Compliant)

Luminous flux tolerance	+/-10%
Initial chromaticity	SDCM5
Power consumption tolerance	+/-10%

Product Data

Order product name	DN392X LED17/9TNW P15PSD D150 WH WP G2
Full product name	DN392X LED17/9TNW P15PSD D150 WH WP G2
Order code	911401503945
Material Nr. (12NC)	911401503945
Numerator - Quantity Per Pack	1
Numerator - Packs per outer box	1

Dimensional drawing

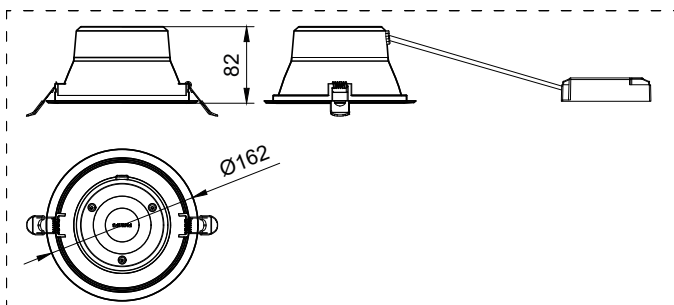

GreenSpace G6

