



LumiStreet gen2

BGP293 LED149-4S/740 II DM50 D9 48/60S

LumiStreet gen2, Road & street light, 84 W, 12900 lm, 4000 K, CRI70, DALI, Distribution medium 50, Safety class II, IP66

Designed for ledification projects, the LumiStreet gen2 is the ideal 1:1 luminaire replacement for municipalities. Thanks to its high efficiency and low initial cost, the LumiStreet gen2 luminaire enables a fast payback and significant savings in terms of energy consumption within a short period of time. The ease of installation and maintenance is enabled by the Philips Service tag and the Philips SR (System Ready) Zhaga socket(s) makes it future-ready, and you can pair this luminaire with lighting control or sensors and software applications such as Interact City. Available with a significant number of different optics and lumen packages that can even be tuned further to fit exact project requirements, LumiStreet gen2 is a true point-to-point replacement solution for conventional or generation 1 LED light sources. The compact luminaire, using high-quality materials is also easy to dismantle and recycle at the end of its lifetime.

Product data

General Information	
Lamp family code	LED149 [LED module 14900 lm]
Light source replaceable	Yes
Number of gear units	1 unit
Driver included	Yes
Light source engine type	LED
Service tag	Yes
Lighting Technology	LED
Value ladder	Specification
Serviceability class	Class A, luminaire is equipped with serviceable parts (when applicable): LED board, driver, control units, surge protection

	device, optics, front cover and mechanical parts
Warranty period	5 years
Sustainability rating	Signify Circle
Light Technical	
Upward light output ratio	0
Luminous Flux	12,900 lm
Correlated Color Temperature (Nom)	4000 K
Luminous Efficacy (rated) (Nom)	154 lm/W
Color rendering index (CRI)	70
Light source color	740 neutral white

LumiStreet gen2

Luminaire light beam spread	154° - 31° x 54°
Optic type outdoor	Distribution medium 50
Effective projected area	0.0246 m²

Operating and Electrical

Input Voltage	220 to 240 V
Line Frequency	50 to 60 Hz
Inrush current	53 A
Inrush time	0.3 ms
Power Consumption	84 W
Power Factor (Fraction)	0.99
Connection	2 Push-in connector 5-pole
Cable	-
Number of products on MCB of 16 A type B	10
Protection class IEC	Safety class II
Surge Protection (Common/Differential)	Surge protection level until 6 kV differential mode and 8 kV common mode

Controls and Dimming

Dimmable	Yes
Driver/power unit/transformer	Power supply unit with DALI interface
Control interface	DALI
Constant light output	No
DALI Standard	DALI-2™
Maximum dim level	0% (digital)

Mechanical and Housing

Housing Material	Aluminum die cast
Reflector material	Polycarbonate
Optic material	Polymethyl methacrylate
Optical cover material	Glass
Fixation material	Aluminum
Housing Color	Gray
Mounting device	Side-entry for diameter 48 to 60 mm
Optical cover shape	Flat
Optical cover finish	Clear
Overall length	626 mm
Overall width	340 mm
Overall height	95 mm
Dimensions (Height x Width x Depth)	95 x 340 x 626 mm
Ingress protection code	IP66 [Dust penetration-protected, jet-proof]
Mech. impact protection code	IK09 [10 J]
Standard tilt angle posttop	0°
Standard tilt angle side entry	0°
Optical cover type	Flat glass
Net Weight (Piece)	6.500 kg

Approval and Application

Flammability mark	For mounting on normally flammable surfaces
CE mark	Yes
ENEC mark	ENEC plus mark
EU RoHS compliant	Yes
Performance ambient temperature Tq	25 °C
Remarks	* At extreme ambient temperatures the luminaire might automatically dim down to protect components
Ambient temperature range	-40 to +50 °C

Initial Performance (IEC Compliant)

Luminous flux tolerance	+/-7%
Initial chromaticity	(0.381, 0.379) SDCM <5
Power consumption tolerance	+/-10%
Init. Color Rendering Index Tolerance	+/-2
Standard Deviation of Colour Matching (McAdam ellipse)	SDCM≤5

Over Time Performance (IEC Compliant)

Driver failure rate at 5000 h	0.5 %
Control gear failure rate at median useful life 50000 h	5 %
Control gear failure rate at median useful life 100000 h	10 %
Lumen maintenance (EN-IEC 62722-2-1) at median useful life* 50000 h	L98
Lumen maintenance (EN-IEC 62722-2-1) at median useful life* 100000 h	L96

Product Data

Order product name	BGP293 LED149-4S/740 II DM50 D9 48/60S
Full product name	BGP293 LED149-4S/740 II DM50 D9 48/60S
Full product code	871951407988500
Order code	910925866723
Material Nr. (12NC)	910925866723
Numerator - Quantity Per Pack	1
EAN/UPC - Product/Case	8719514079885
Numerator - Packs per outer box	1
EAN/UPC - Case	8719514079885
Product family code	BGP293 [LumiStreet gen2 Medium]

LumiStreet gen2

Dimensional drawing

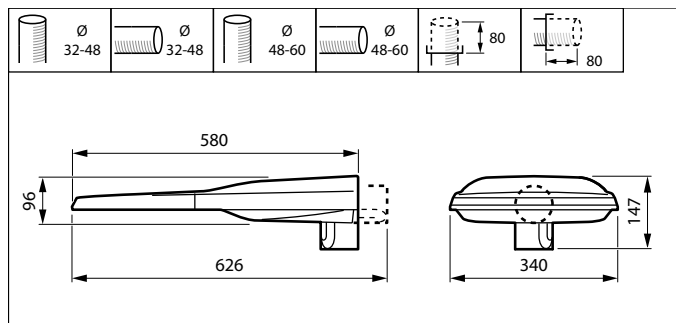

Photometric data

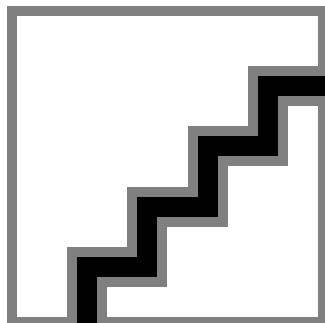

Polar Normal (separate) - BGP283I - 910925866762

