

### System Overview

These instructions review how to install Jump suspended fixtures. Jump 4ft and 8ft modules can be installed as individual standalone units, or they can be joined together to create continuous runs. The graphic below shows the components required to install a typical run of Jump suspended fixtures.

#### Jump joint kit(s)\*

- A/C mounting bracket (x1)
- Break apart joiner aligner (x1)
- #8-32 x 1/2" screw (x2)
- #8-32 Hex Nut (x2)
- Gasket (x1)
- Power Plate (x2)
- Plug 1/2 (x2)

\*NOTE: 11 kit required for each in-run joint.

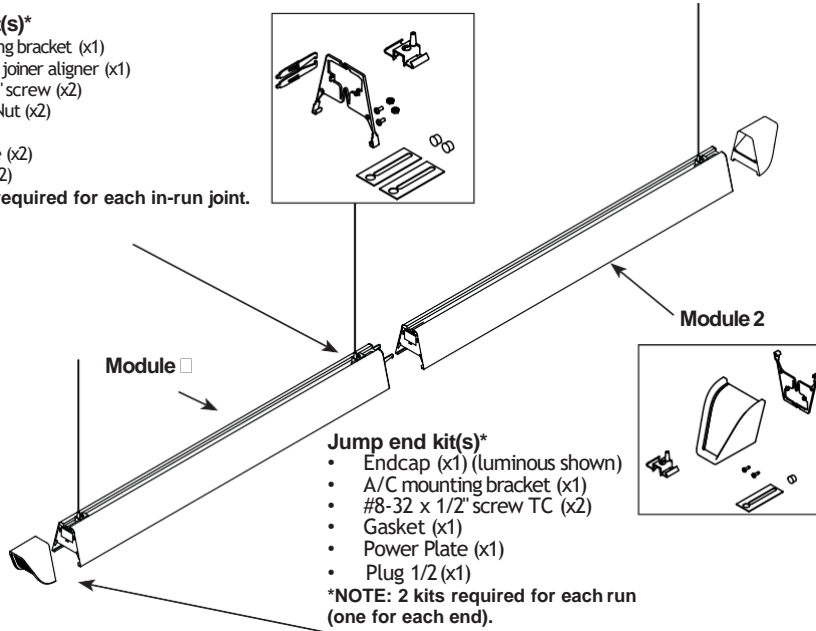

TOOLS REQUIRED: Philips screwdriver, 3/8" nut driver.

### Module Lengths

Jump suspended systems come in 4ft and 8ft modules. Overall module lengths are shown below. Module lengths do not include endcaps.

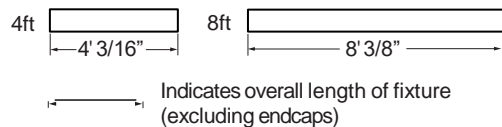

### Endcaps

Add two endcaps to the length of each run.



### Mount Spacing

For on-grid T-bar ceiling installations, mounts attach directly to T-Bar. For non-accessible ceilings and off-grid T-bar installations, the graphic below indicates mount spacing for typical run lengths.

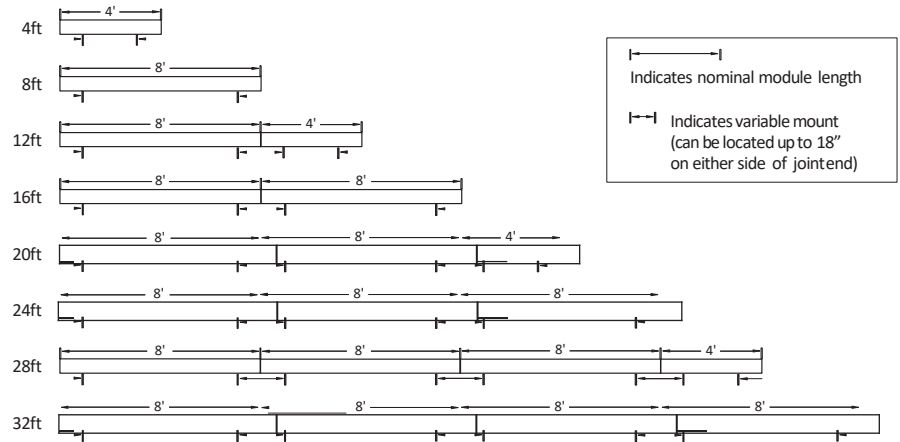

### Run Configurations

The tables below indicate how 4ft and 8ft modules can be combined to create continuous runs of various lengths.

Nomina l Row Length	Number of Modules Required		Installed Row Length <i>(not including end caps)</i>
	4'	8'	
4'	1x		4' - 3/16"
8'		1x	8' - 3/8"
12'	1x	1x	12' - 9/16"
16'		2x	16' - 3/4"
20'	1x	2x	20' - 15/16"
24'		3x	24' 1 - 1/16"
28'	1x	3x	28' 1 - 1/4"
32'		4x	32' 1 - 7/16"
36'	1x	4x	36' 1 - 5/8"
40'		5x	40' 1 - 13/16"
44'	1x	5x	44' 1"
48'		6x	48' 2 - 3/16"

Nomina l Row Length	Number of Modules Required		Installed Row Length <i>(not including end caps)</i>
	4'	8'	
56'		7x	56' 2 - 9/16"
60'	1x	7x	60' 2 - 11/16"
64'		8x	64' 2 - 7/8"
68'	1x	8x	68' 3 - 1/16"
72'		9x	72' 3 - 1/4"
76'	1x	9x	76' 3 - 7/16"
80'		10x	80' 3 - 5/8"
84'	1x	10x	84' 3 - 13/16"
88'		11x	88' 3"
92'	1x	11x	92' 4 - 3/16"
96'		12x	96' 4 - 3/8"
100'	1x	12x	100' 4 - 1/2"

\*Overall run lengths provided do not include endcaps. Add two endcaps to the overall length of each run.

### 1 Prepare Fixtures / Install ceiling mounting components

Arrange boxed fixtures on floor in specified mounting locations; remove fixtures from boxes. Install all ceiling mounting components and vertical aircraft cables using separate installation instructions for Aircraft Cable Mounting (supplied).

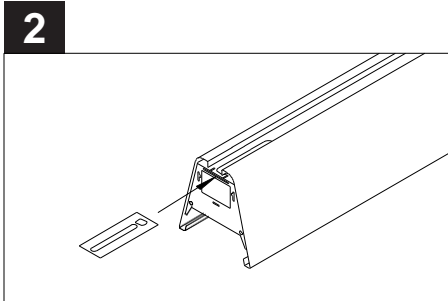

Slide in power cover and install bushing (power location) or plug (non-power location) on both ends. Install one gasket per joint.

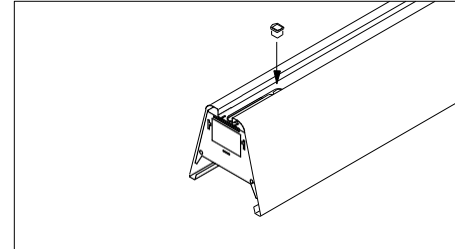

### 3 Install Aircraft Cable brackets

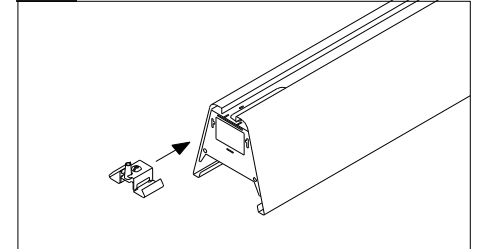

Slide A/C mounting bracket into mounting channel to the mounting position, and tighten locking bracket until screw is tight. **Mounting position can be up to 18" from end.**

If desired mounting location is directly over a joint, position A/C bracket and lock in a position first where all teeth engage into channel, then move into correct position after 2nd fixture is installed.

### 4 Suspend and Level First Fixture

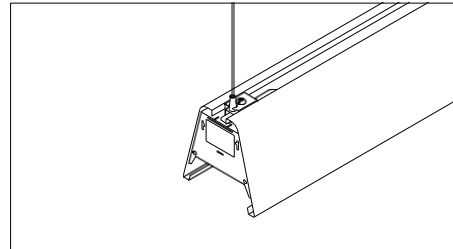
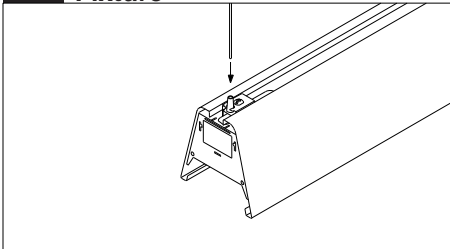

With two people, raise first fixture to ceiling. At each end of fixture, insert aircraft cable through aircraft cable adjuster (located on A/C mounting bracket). The adjuster will automatically grip and hold the cable.

**IMPORTANT:** Do not force cable into adjuster. See instruction **A** (next page) for details. To level fixture, support fixture from below and use supplied aircraft cable release tool to make fine height adjustments.

### 5 Attach Clips and Tuck Wires

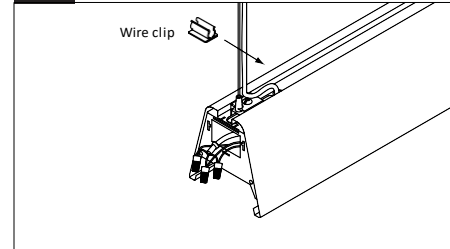

**POWER LOCATIONS:** Attach cable clips at 4 increments between power drop and bushing in power cover. Feed power cord through bushing (shown above). Complete electrical connections using wire nuts (supplied by others). Tuck wires into wire cavity.

**NON-POWER LOCATIONS:** Cap all wires and tuck into wire cavity.

### 6 Install Joiner Aligners

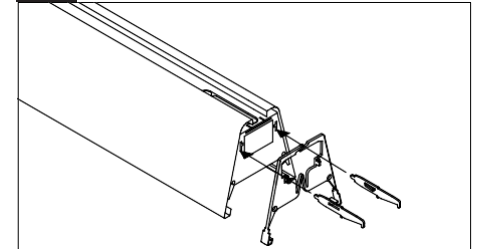

Slide joiner aligner brackets into corresponding slots in fixture cross plate.



**ATTENTION:** Install in accordance with national and local building and electrical codes.

### 7 Suspend and Join Additional Fixtures to Create Row

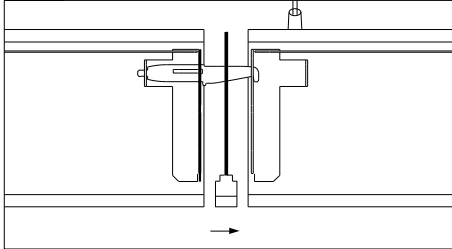

With two people, raise second fixture to ceiling. At end of fixture (opposite joint), insert aircraft cable through adjuster. At joint, rest fixture on in-run joiner bracket. **IMPORTANT: Do not attempt to join fixtures on floor. Instead, hang one fixture at a time and join modules at ceiling level.**

### 8 Complete Electrical Connections at Joints

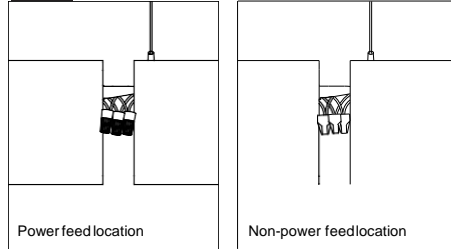

Complete in-run electrical connections. **NON-POWER LOCATIONS** (shown above): Use supplied quick-wire connectors. Tuck wires into wire cavity. **POWER LOCATIONS**: Feed power cord through bushing in bracket. Use wire nuts (supplied by others) to complete connections. Tuck wires into wire cavity.

### 9 Secure Joints and Level all Fixtures

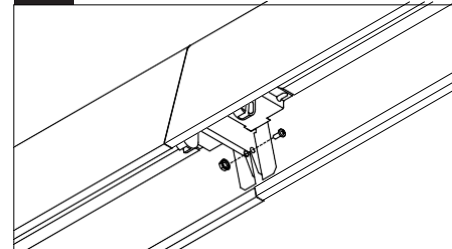

Slide modules together; secure joint from below using supplied nut and screw hardware (requires Phillips driver).

**IMPORTANT: Ledalite recommends tightening fasteners by hand. When joining modules, ensure screw is tightened snug plus an additional 1/4 turn.**

**LEVEL FIXTURE:** See A below. Repeat STEPS 4-7 for each additional fixture in row.

### 10 Install endcaps

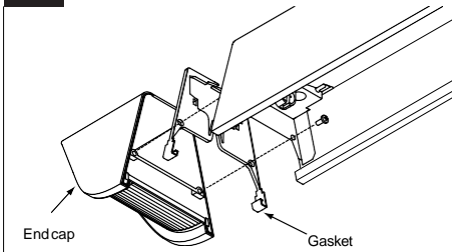

Snap on the gasket to the end of the fixture and attach end caps using supplied #8 screws.

### 11 Finishing

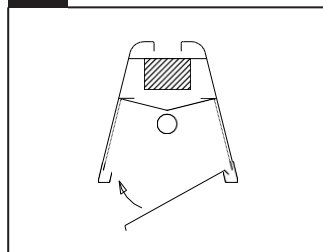

Install lenses as shown.

This equipment has been tested and found to comply with the limits for a Class A digital device, pursuant to part 15 of the FCC Rules. These limits are designed to provide reasonable protection against harmful interference when the equipment is operated in a commercial environment. This equipment generates, uses, and can radiate radio frequency energy and, if not installed and used in accordance with the instruction manual, may cause harmful interference to radio communications. Operation of this equipment in a residential area is likely to cause harmful interference in which case the user will be required to correct the interference at his own expense.

### Aircraft cable adjustment

**IMPORTANT: Do not force cable into adjuster. To insert cable into adjuster, follow the steps below.**

#### 1. CUT

If required, cut cable ends cleanly prior to inserting into adjuster. Recommended cutters: K.K. Porter cable cutter cat. No. 0690TN or Klein all purpose shears cat. No. 1104.

#### 2. INSERT

Carefully insert cable into tapered end. If cable does not insert easily or becomes jammed during insertion, use the release tool to remove cable. Trim end again and repeat process. **DO NOT BEND CABLE BELOW BOTTOM OF ADJUSTER.**

#### 3. TEST

Once cable is inserted, apply a 25lb point load to each mount bracket to ensure all connections are secure.

### A Level vertically

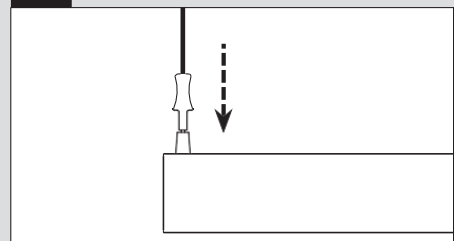

**LEVEL VERTICALLY** (shown above): Support fixture from below and use supplied aircraft cable release tool to make fine height adjustments (see instruction A for details).

**NOTE: Ensure fixture is level end-to-end. Support fixture from below and use supplied aircraft cable release tool to make fine height adjustments.**



**ATTENTION: Install in accordance with national and local building and electrical codes.**

### Sensor in Rows

#### Single Sensor Controlling Whole Row

1. Purple & brown (or purple & grey/pink) control wires **MUST** be connected between fixtures.
- Note :
- A maximum of 8 drivers can be wired to 8 sensors; confirm fixture driver count with factory.

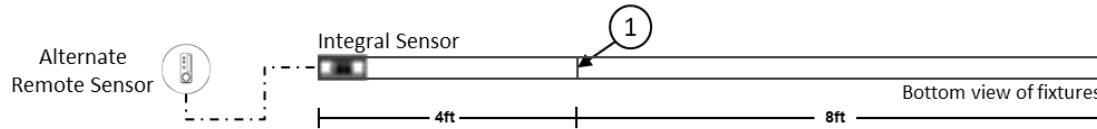

#### Multiple Sensors Controlling Separates Zones in a Row

2. Purple & brown (or purple & grey/pink) control wires **MUST NOT** be connected between zones.
- Notes :
- A maximum of 8 drivers can be wired to one sensor; confirm fixture driver count with factory.
  - Only one sensor is allowed on a wired zone. (Sensors can be paired together wirelessly via a mobile app).

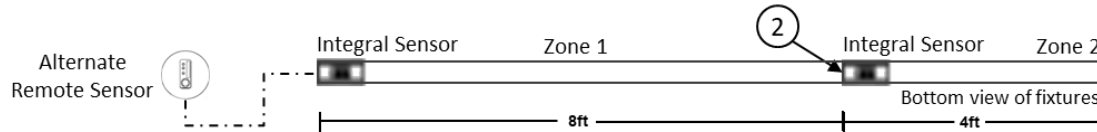

#### Sensor Spacing

- For correct operation, sensor should be placed a minimum distance of 8ft apart.
- Wireless sensor should be placed no further than 40ft apart for good wireless signal connection.

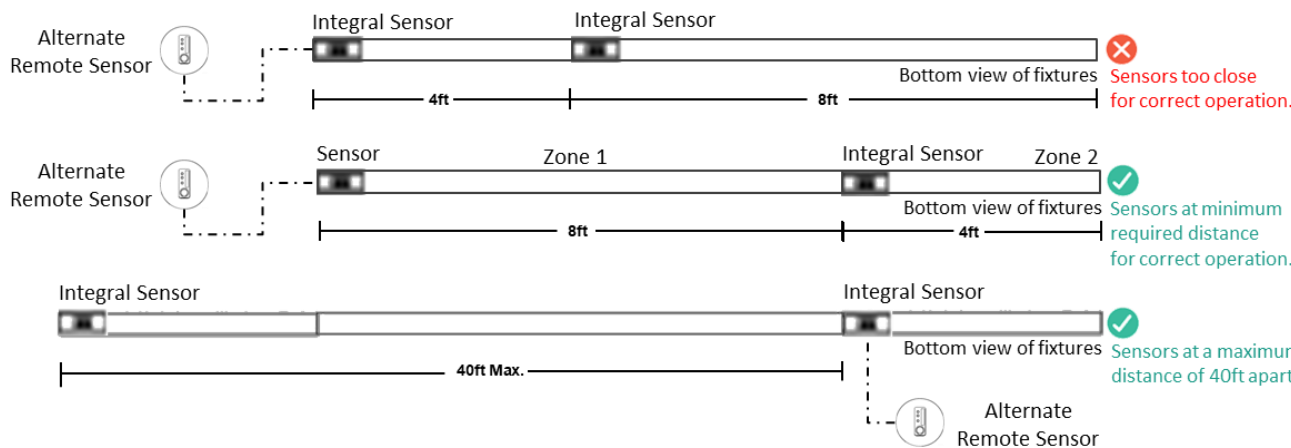

### Important Consideration When Using Sensor in a Row

- For fixtures with wireless sensors (CS, SB or RA options): **DO NOT** connect fixture purple and brown (or purple & grey/pink) control wires to an external dimming switch. Fixture mains wiring should not be connected to a circuit with an external on/off switch.
- For best aesthetic condition, place sensors at ends of row only so as not to break the continuous lens.
- For better occupancy coverage in longer rows, sensors may be placed mid run, but keep in mind this will break the continuous lens into discrete sections. Alternatively, remote sensors may be used, note the same wiring rules will apply.



**ATTENTION: Install in accordance with national and local building and electrical codes.**

### Occupancy Sensor Coverage:

Note: Longer dimension of detection area (Y1, Y2) is parallel to longer dimension of the luminaire.

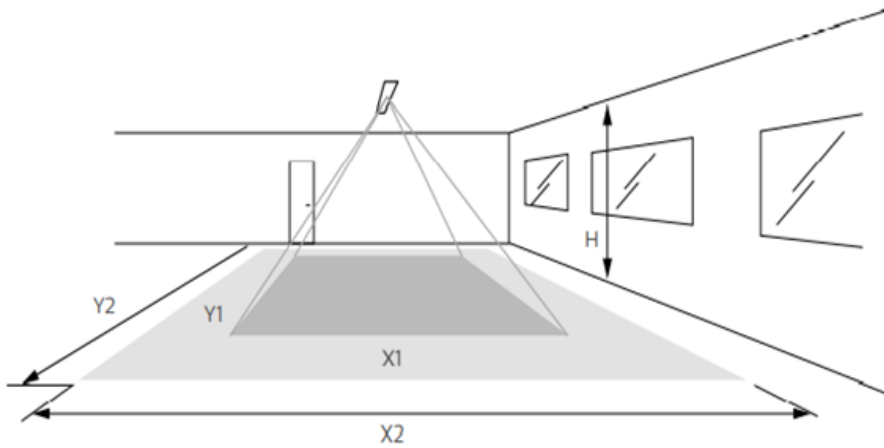

### Daylight Sensor

The light sensor measures the total amount of light in a circular field of approximately 80% of the PIR detection area. The following aspects should be observed during installation:

- Minimum distance from the window = 2ft (0.6m).
- Prevent light reflections from outside entering the sensor (for example sunlight reflection on a car hood) as this will lead to incorrect light regulation.

As a guideline the formula  $0.72 \times H$  can be used to calculate the minimum distance between the window and sensor whereby H is the height from the bottom of the window to the sensor.

### Photosensor spatial response

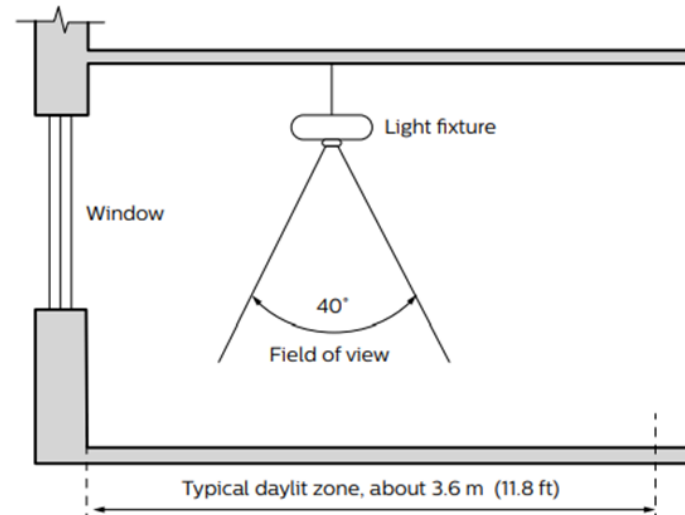

Height	Minor movement		Major movement	
h	X1	Y1	X2	Y2
2.4 m (7.9 ft)	1.9 m (6.2 ft)	2.9 m (9.5 ft)	2.9 m (9.5 ft)	4.3 m (14.1 ft)
3 m (9.8 ft)	2.4 m (7.9 ft)	3.6 m (11.8 ft)	3.6 m (11.8 ft)	5.4 m (17.7 ft)

The detection area for the movement sensor can be roughly divided into two parts;

- Minor movements (person moving = 3ft/s or 0.9m/s).
- Major movements (person moving = 3ft/s or 0.9m/s).



**ATTENTION:** Install in accordance with national and local building and electrical codes.