

INSTALLATION INSTRUCTIONS

SLENDERFORM RECESSED (SFCR)

Signify North America Corporation
200 Franklin Square Drive
Somerset N.J. 08873, USA

Signify Canada Ltd./Signify Canada Ltée.
281 Hillmount Road,
Markham, ON, Canada L6C 2S3

THESE INSTRUCTIONS APPLY TO THE SFCR (SLENDERFORM RECESSED) FAMILY INTENDED TO BE INSTALLED IN A NON-INSULATED, COVERED CEILING.

IMPORTANT! BE SURE ALL POWER IS OFF PRIOR TO INSTALLING LUMINAIRES. READ ALL INSTRUCTIONS BEFORE PERFORMING ANY WORK

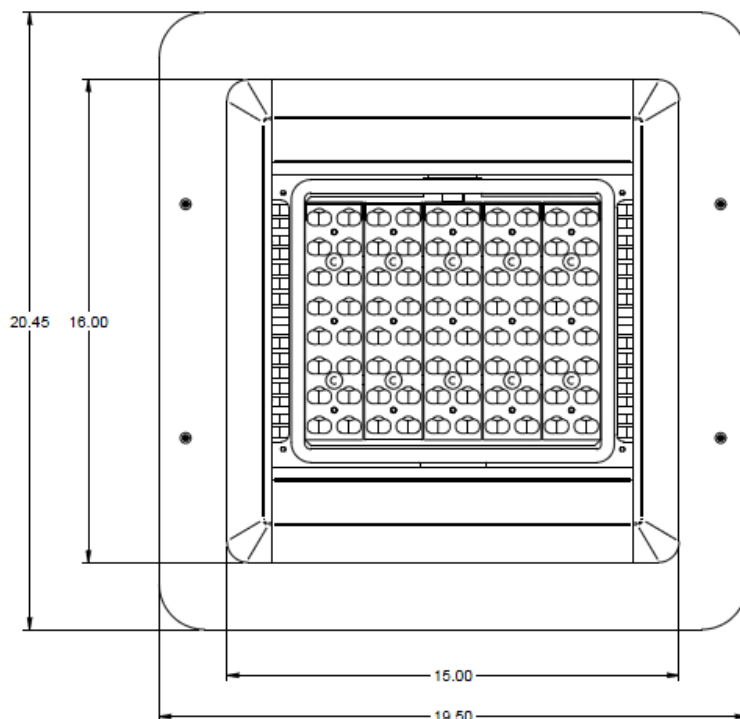
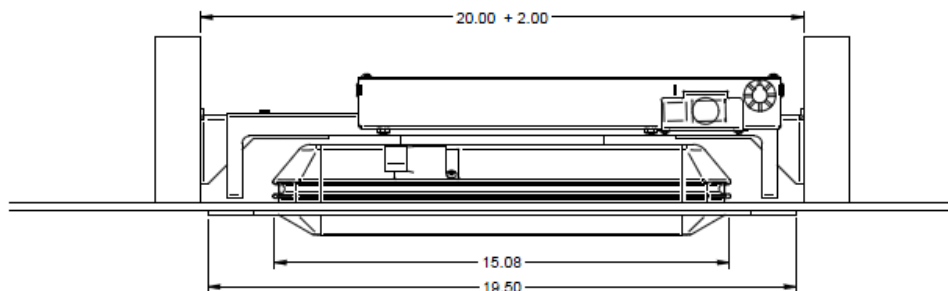

INSTALLATION INSTRUCTIONS

SLENDERFORM RECESSED (SFCR)

Signify North America Corporation
200 Franklin Square Drive
Somerset N.J. 08873, USA

Signify Canada Ltd./Signify Canada Ltée.
281 Hillmount Road,
Markham, ON, Canada L6C 2S3

CEILING PREPARATION

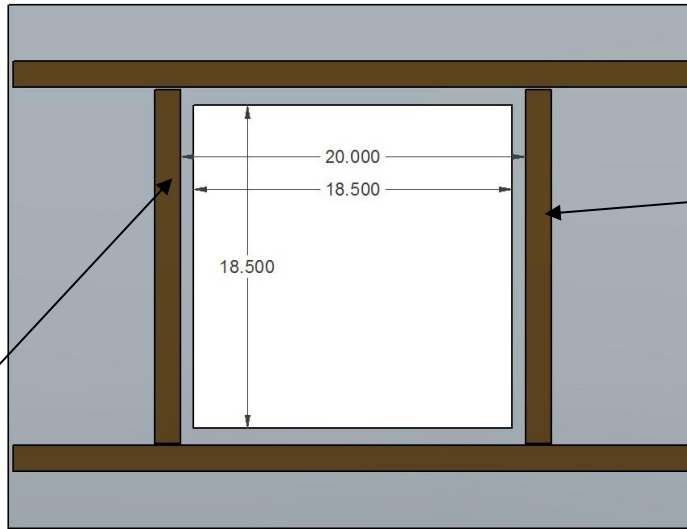

18.5" SQUARE
CUT OUT FOR
UNIT CLEARANCE
CENTERED IN
OPENING

MOUNTING SUPPORT
BRACKETS REQUIRE A
RANGE OF 20-23.4"

COMPONENTS:

COSMETIC COVER



CEILING BRACKET
ASSEMBLY

LUMINAIRE WITH FLEX CONDUIT AND
MOUNTING BRACKET

STEP 1: ON BACK OF MOUNTING BRACKET LOOSEN 4X ADJUSTMENT SCREWS

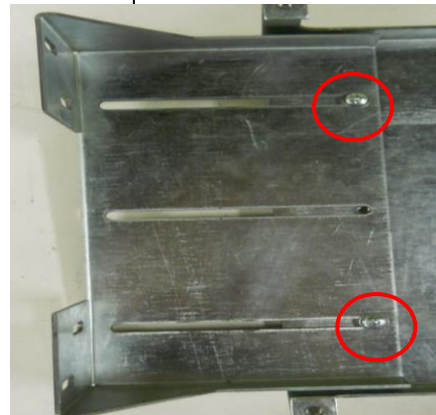
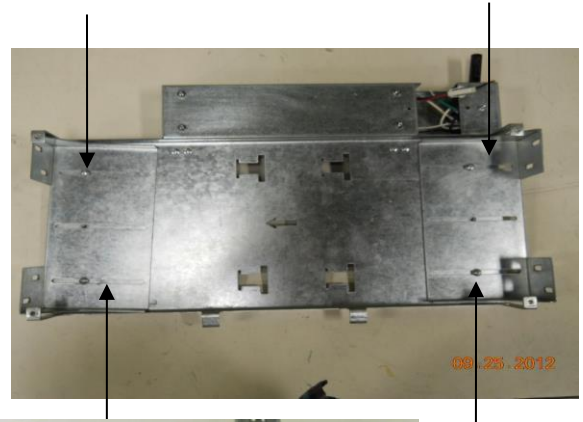

INSTALLATION INSTRUCTIONS

SLENDERFORM RECESSED (SFCR)

Signify North America Corporation
200 Franklin Square Drive
Somerset N.J. 08873, USA

Signify Canada Ltd./Signify Canada Ltée.
281 Hillmount Road,
Markham, ON, Canada L6C 2S3

STEP 2: SLIDE 2X SIDE BRACKETS INWARD

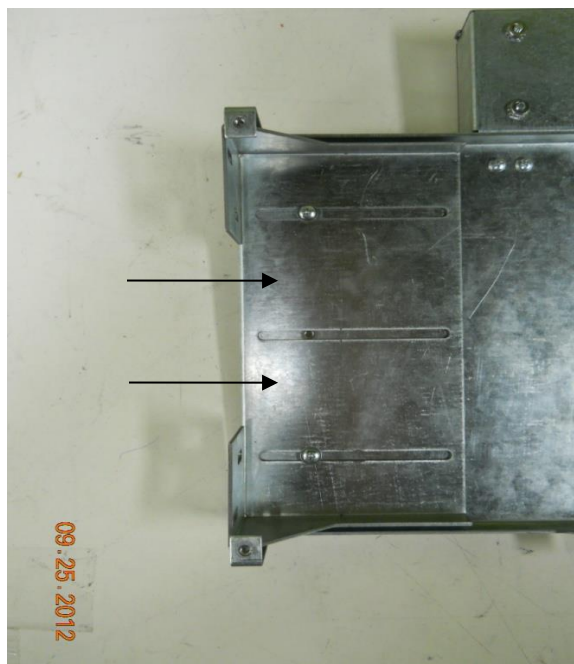

STEP 3: PLACE MOUNTING BRACKET INTO CEILING AND EXTEND SIDE BRACKETS OUTWARD

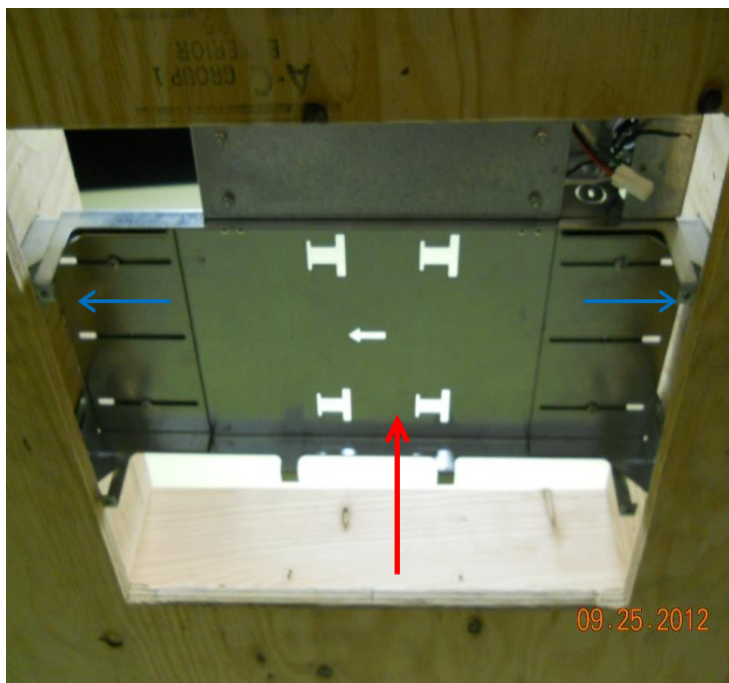

USE 4X WASHERS AND
SCREWS TO SECURE
SIDE BRACKETS TO
STUD (HARDWARE
SUPPLIED BY OTHERS)

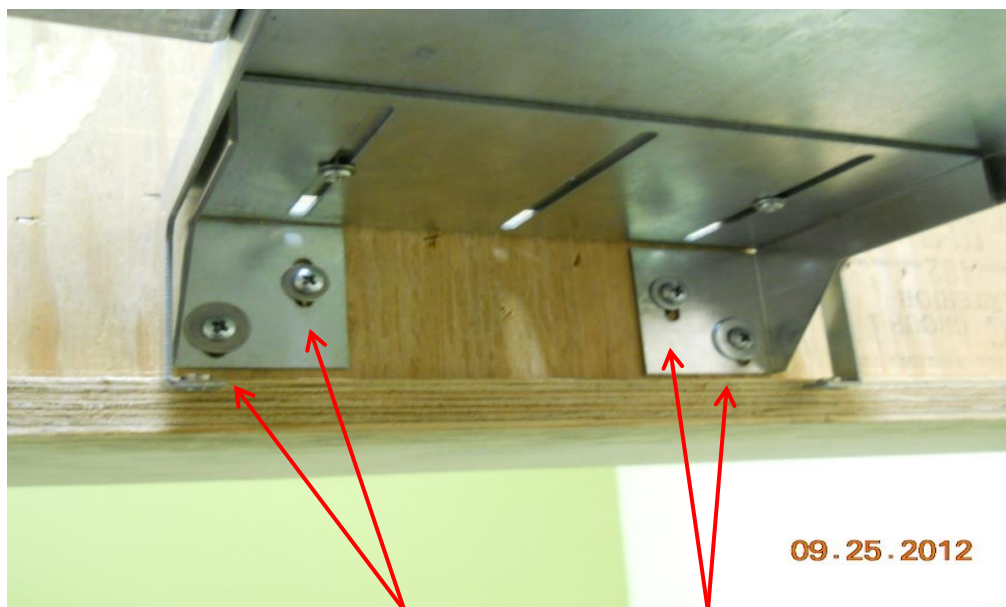

INSTALLATION INSTRUCTIONS

SLENDERFORM RECESSED (SFCR)

Signify North America Corporation
200 Franklin Square Drive
Somerset N.J. 08873, USA

Signify Canada Ltd./Signify Canada Ltée.
281 Hillmount Road,
Markham, ON, Canada L6C 2S3

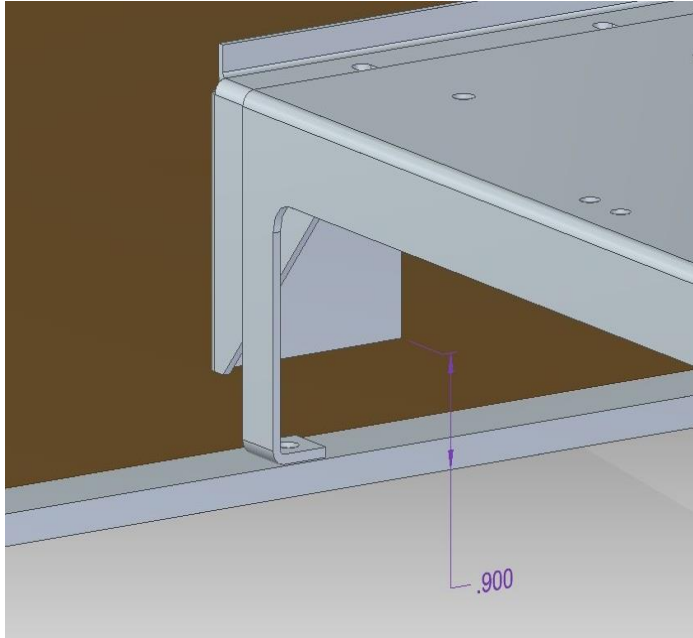

NOTE: For the fixture to mount flush with the ceiling it is important that the side brackets adjacent to the mounting bracket be raised so that the bottom of the bracket sits 9/10" from the room side of the ceiling.

STEP 4: CONNECT OUTSIDE POWER LINES TO LINES EXITING CONDUIT ON LUMINAIRE. SECURE PROVIDED CONDUIT BASED ON INSTALLATION SITE CONSTRUCTION. USE WIRE-NUTS TO CONNECT THE OUTSIDE POWER TO THE FIXTURE'S CONNECTIONS. BLK TO BLK, WHT TO WHT, GRN TO GRN (PURP & GRAY IF DIMMING).



INSTALLATION INSTRUCTIONS

SLENDERFORM RECESSED (SFCR)

Signify North America Corporation
200 Franklin Square Drive
Somerset N.J. 08873, USA

Signify Canada Ltd./Signify Canada Ltée.
281 Hillmount Road,
Markham, ON, Canada L6C 2S3

USE CUTOUTS ON FIXTURE BRACKET TO HANG THE FIXTURE ON THE TOP MOUNTING BRACKET FOR EASE OF CONNECTION.

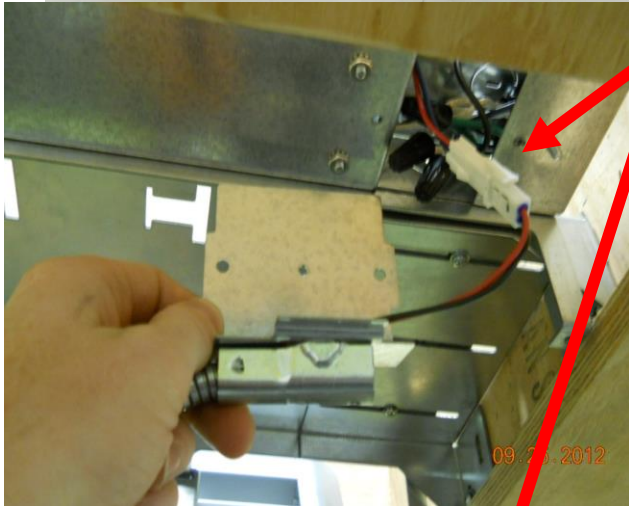
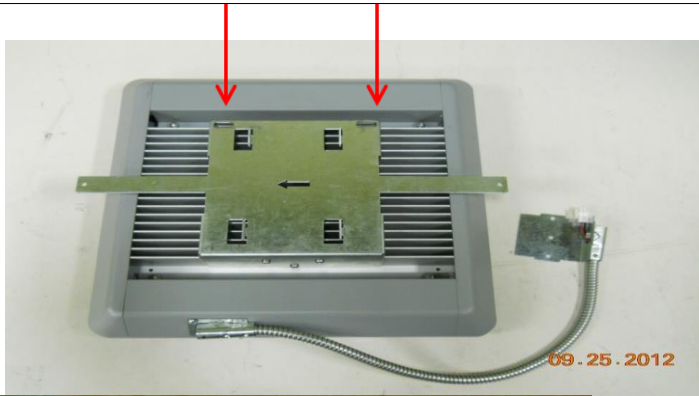

STEP 5: CONNECT THE CABLE FROM THE LUMINAIRE TO THE MATING HARNESS OF THE DRIVER. SECURE THE CABLE TO THE DRIVER BRACKET WITH 2X #8-32 X 5/16" SCREWS.

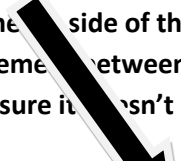
Place the luminaire to the  side of the opening. Note the flex conduit and its placement between luminaire and mounting bracket to be sure it doesn't prevent proper mounting.



INSTALLATION INSTRUCTIONS

SLENDERFORM RECESSED (SFCR)

Signify North America Corporation
200 Franklin Square Drive
Somerset N.J. 08873, USA

Signify Canada Ltd./Signify Canada Ltée.
281 Hillmount Road,
Markham, ON, Canada L6C 2S3

STEP 6: PUSH THE LUMINAIRE UP INTO THE MOUNTING BRACKET AND SLIDE THE LUMINAIRE IN THE DIRECTION OF THE ARROW TO LOCK IT IN PLACE. (AS SHOWN IN THE TOP VIEWS BELOW)

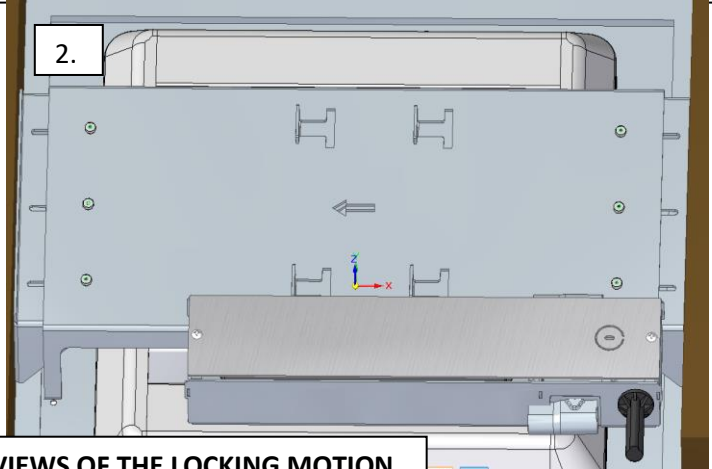
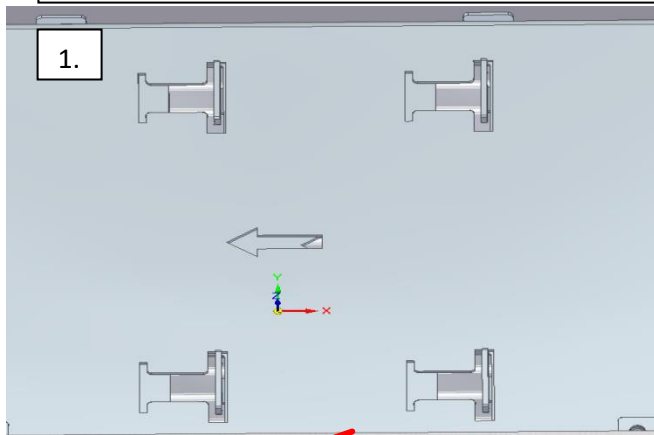

BELOW SHOWS THE ROOM SIDE VIEWS OF THE LOCKING MOTION.



STEP 7: RELEASE THE FIXTURE; IT SHOULD HANG SECURELY IN PLACE. ON EITHER SIDE OF THE FIXTURE ARE LOCK TABS. USE 2X #8-32 X 1/2" TO SECURE THE FIXTURE TO THE TOP MOUNTING BRACKET.

STEP 8: MOUNT THE COSMETIC COVER TO THE FIXTURE USING 4X #8-32 X 5/8" FLAT HEAD MACHINE SCREWS.



INSTALLATION INSTRUCTIONS

SLENDERFORM RECESSED (SFCR)

Signify North America Corporation
 200 Franklin Square Drive
 Somerset N.J. 08873, USA

Signify Canada Ltd./Signify Canada Ltée.
 281 Hillmount Road,
 Markham, ON, Canada L6C 2S3

WIRING DIAGRAM: FOR USE WITH 120 OR 277V INPUT ONLY – THERMAL PROTECTION OPTIONAL

SENSOR PRE-WIRED IN
 J-BOX COVER AT FACTORY
 DO NOT DISCONNECT!

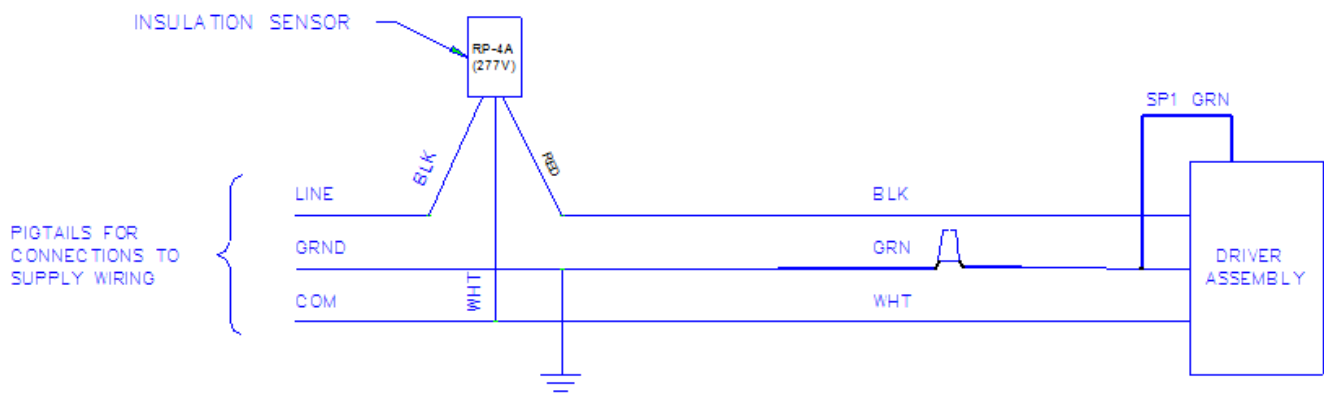
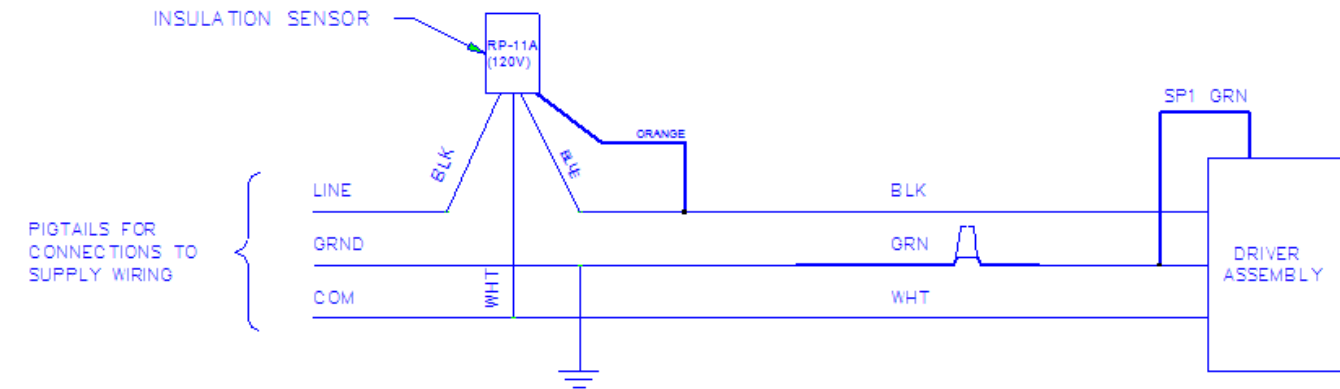

INSULATION SENSOR WIRING DIAGRAM