

Complete unit
Fixture +
optional
accessories



A high brightness LED track solution in a multi-optic LED design. Ideal for customers concern with energy, beam quality and visual performance. Multiple accessories available to customize the light output and visual appearance of the fixture.

Project: _____
 Location: _____
 Cat.No: _____
 Type: _____
 Lamps: _____ Qty: _____
 Notes: _____

Fixture

example: LLAB340RNFALVA

Series	CCT	Reflector	Adapter	Finish	Version
LLAB3					VA
LLAB3 Spot LED 39W/3000lm	27 2700K 30 3000K 40 4000K	RS 8° Spot RNF 23° N.Flood RF 40° Flood	— Lightolier H Halo J Juno	WH White AL Alum. BK Black	VA Version A

Accessories¹

example: 23SNT6AL

Series	Finish
LLAB1AH Accessory holder ²	WH Matte white BK Matte black
23SNT6 Compatible Snoot	WH Matte white BK Matte black AL Aluminum
AL4HC Compatible Hex cell louver (matte black)	

- Accessories are not Energy Star qualified.
- Accessory holder accept two accessories.

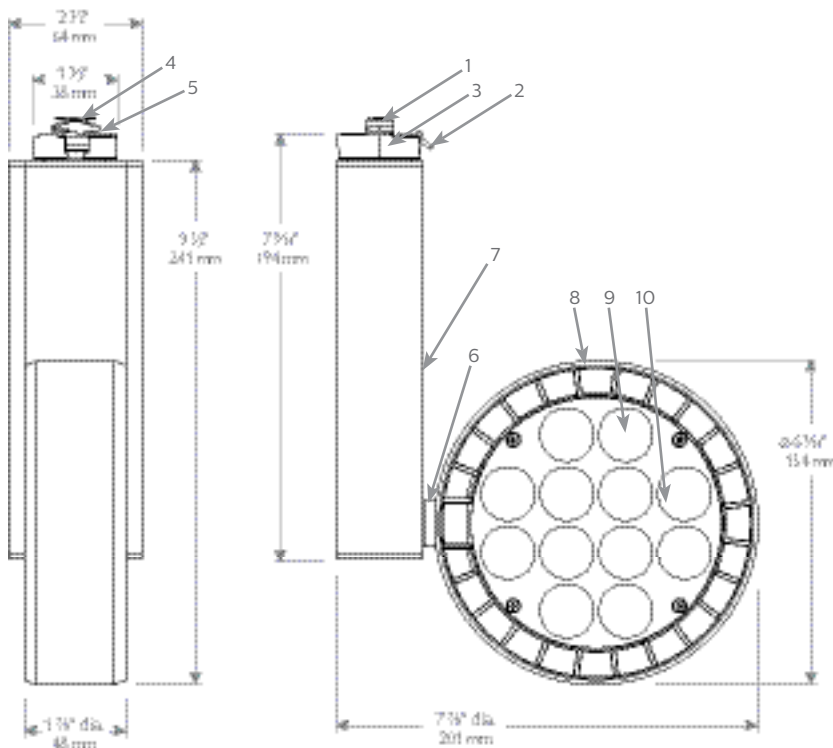

Features

- Track attachment fitting:** Molded polycarbonate. Integral color in gray, black or white. Rotates into track and locks into place with the use of push tab.
- Push tab:** Molded polycarbonate. Locks and detaches unit.
- Track adapter housing:** Die cast aluminum. Steel eyelet friction connection. Rotates 350°.
- Movable contact:** Solid Brass. Extends for connection to 2cd circuit in Advent track.
- Ground contact:** Solid Brass.
- Vertical pivot mount:** Stainless steel eyelet friction connection. Rotates +/- 90° from vertical aim to floor.
- Driver housing:** Extruded aluminum with die cast aluminum end caps.
- Integrated heat sink:** Die cast aluminum effectively cools LEDs providing a minimum 54,000 hour lifetime at 70% lumen maintenance.
- Light source:** 12 high brightness white led. 80-85 CRI, LEDs selected for tight color consistency between luminaires single 3 step MacAdam ellipse max.
- Optic assembly:** Efficient TIR (total internal reflection) optically clear thermoplastic lenses held securely by frosted translucent thermoplastic holder. Positive securement into luminaire with screws and accurately positioned on LEDs with locating pins. Prevents dust and contaminants from entering LED compartment.

LLAB3-VA Spot LED

39W/3000lm

Electrical

Electronic power supply

Input voltage: 120V, 50/60Hz

Input power: 39W (nominal)

High power factor: >0.9

CRI: 80 (typical)

Lumen maintenance:

>70% of initial lumens @ 54,000 hours.

Photometric performance:

Tested in accordance to LM79.

12 LED array: 3000K (Luxeon T)

Reflector	Beam sprd	Lms	Efficacy	CBCP
RS	8°	3060	78	82,040
RNF	23°	2787	71	11,756
RF	40°	2807	72	5,519

Mounting

Basic track, Advent track, and Monopoints.

Dimming

Trailing edge (ELV) dimming
(refer to LED-DIM spec sheet for more details.)

SR400RPC120 Philips Controls (7%)

SELV-300P Lutron Skylark (14%)

6615-POW Leviton (17%)

Finish

Powder coated finish.

Labels

cULus listed. 5 year warranty.

Energy Star qualified (standard product).



Accessories

1. Fixture kit
2. Diffusion filter (n/a)
3. Hex cell louver
4. Snoot
5. Accessory holder

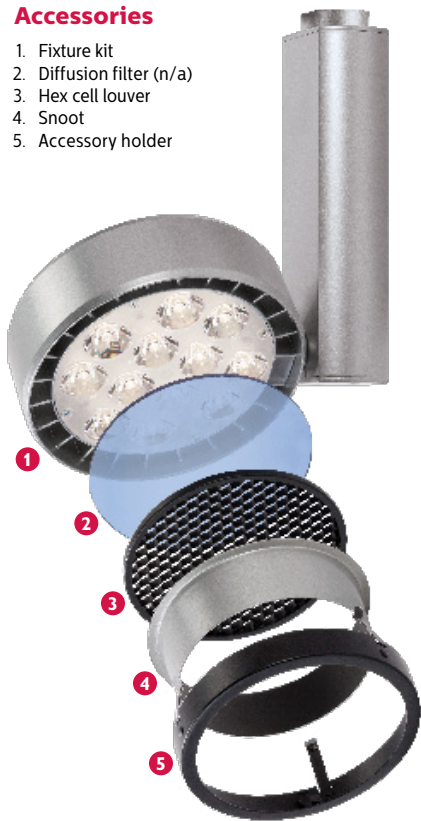

Hex cell louvers

AL4HC = 4 3/4" dia.



AL4HC
only available
in matte black

LLAB3-VA Spot LED

39W/3000lm

Aiming angles

L and W are the outer points where the candle power drops to 50% of the maximum. FC are the initial footcandles at the center of the beam. Data shown is for 3000K, for 2700K multiply FC by 0.91.

- L Beam length
- D Distance
- W Beam Width
- A Aiming Angle
- FC Footcandles
- C Distance to center beam

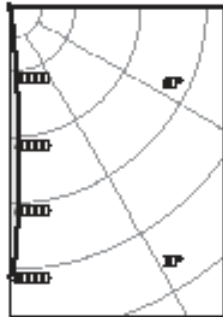
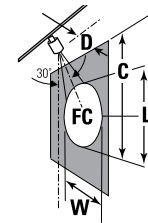
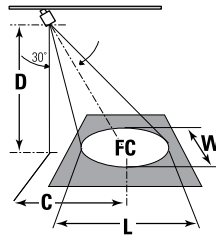

Fixture: LLAB330RSALVA

CCT¹: 3000K
 Output lumens: 3060 lms
 Input watts²: 39.3 W
 Efficacy: 77.9 lm/w
 CRI: 80 min
 CBCP.: 82,040 cd
 Beam Angle: 8°
 Report no³: 803GFR

Spot

30° Horizontal Aiming

Distance		F.C.	Beam	
D	C		L	W
6	3.5	1480	1.1	1.0
8	4.6	833	1.5	1.3
10	5.8	533	1.9	1.6
12	6.9	370	2.2	1.9

30° Horizontal Aiming

Distance		F.C.	Beam	
D	C		L	W
2	3.5	2564	1.1	0.6
3	5.2	1139	1.7	0.8
4	6.9	641	2.3	1.1
5	8.7	410	2.8	1.4

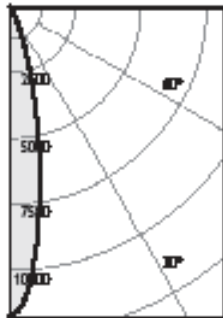

Fixture: LLAB330RNFALVA

CCT¹: 3000K
 Output lumens: 2787 lms
 Input watts²: 39.2 W
 Efficacy: 71.1 lm/w
 CRI: 80 min
 CBCP.: 11,756 cd
 Beam Angle: 23°
 Report no³: 802GFR

Narrow Flood

30° Horizontal Aiming

Distance		F.C.	Beam	
D	C		L	W
6	3.5	212	3.3	2.8
8	4.6	119	4.4	3.8
10	5.8	76	5.5	4.7
12	6.9	53	6.6	5.6

30° Horizontal Aiming

Distance		F.C.	Beam	
D	C		L	W
2	3.5	367	3.7	1.6
3	5.2	163	5.6	2.4
4	6.9	92	7.4	3.3
5	8.7	59	9.3	4.1

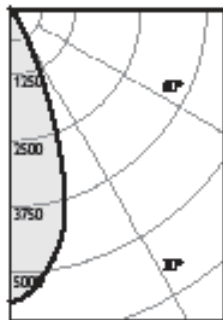

Fixture: LLAB330RFALVA

CCT¹: 3000K
 Output lumens: 2807 lms
 Input watts²: 39.2 W
 Efficacy: 71.6 lm/w
 CRI: 80 min
 CBCP.: 5,519 cd
 Beam Angle: 40°
 Report no³: 801GFR

Flood

30° Horizontal Aiming

Distance		F.C.	Beam	
D	C		L	W
6	3.5	100	6.1	5.0
8	4.6	56	8.1	6.7
10	5.8	36	10.2	8.4
12	6.9	25	12.2	10.1

30° Horizontal Aiming

Distance		F.C.	Beam	
D	C		L	W
2	3.5	172	9.7	2.9
3	5.2	77	14.5	4.4
4	6.9	43	19.3	5.8
5	8.7	28	24.2	7.3



© 2021 Signify Holding. All rights reserved. The information provided herein is subject to change, without notice. Signify does not give any representation or warranty as to the accuracy or completeness of the information included herein and shall not be liable for any action in reliance thereon. The information presented in this document is not intended as any commercial offer and does not form part of any quotation or contract, unless otherwise agreed by Signify.

Signify North America Corporation
 400 Crossing Blvd, Suite 600
 Bridgewater, NJ 08807
 Telephone: 855-486-2216

Signify Canada Ltd.
 281 Hillmount Road,
 Markham, ON, Canada L6C 2S3
 Telephone: 800-668-9008

All trademarks are owned by Signify Holding or their respective owners.