

Row Configurations

Module Lengths

Chopstick™ suspended systems are available in nominal 4ft and 8ft modules. Exact overall module lengths are shown to the right (without endcaps).

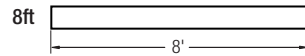
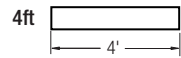

Indicates overall nominal length of module. Module lengths do not include endcaps. Endcap dimensions are shown below.

Endcaps

Overall row lengths do not include endcaps. Add two endcaps to the overall length of each row.

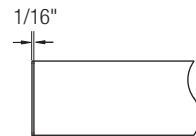

Mount Spacing

For on-grid T-bar ceiling installations, mounts attach directly to Tee. For non-accessible ceilings and off-grid T-bar installations, the graphic below indicates mount spacing for typical row lengths. Mounting options are also available for a wide variety of other ceiling types. See *Suspended Mounting Options* document for more detailed information.

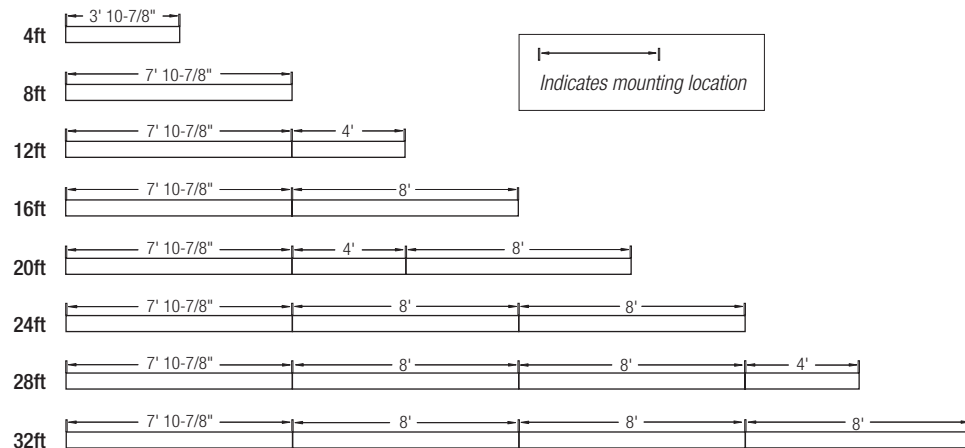

Row Configurations

The table below indicates how nominal 4ft and 8ft modules can be combined to create continuous rows of various lengths. Modules can be combined in any order.

| Nominal Row Length | Number of Modules Required | | Installed Row Length (not including endcaps) |
|--------------------|----------------------------|-----|--|
| | 4' | 8' | |
| 4' | 1x | | 4' 0" |
| 8' | | 1x | 8' 0" |
| 12' | 1x | 1x | 12' 0" |
| 16' | | 2x | 16' 0" |
| 20' | 1x | 2x | 20' 0" |
| 24' | | 3x | 24' 0" |
| 28' | 1x | 3x | 28' 0" |
| 32' | | 4x | 32' 0" |
| 36' | 1x | 4x | 36' 0" |
| 40' | | 5x | 40' 0" |
| 44' | 1x | 5x | 44' 0" |
| 48' | | 6x | 48' 0" |
| 52' | 1x | 6x | 52' 0" |
| 56' | | 7x | 56' 0" |
| 60' | 1x | 7x | 60' 0" |
| 64' | | 8x | 64' 0" |
| 68' | 1x | 8x | 68' 0" |
| 72' | | 9x | 72' 0" |
| 76' | 1x | 9x | 76' 0" |
| 80' | | 10x | 80' 0" |
| 84' | 1x | 10x | 84' 0" |
| 88' | | 11x | 88' 0" |
| 92' | 1x | 11x | 92' 0" |
| 96' | | 12x | 96' 0" |
| 100' | 1x | 12x | 100' 0" |

! ATTENTION: Install in accordance with national and local building and electrical codes. Page 1

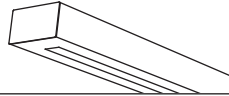

Power Feed

Power for the entire row can be placed at either end or any joint. *See examples below.*

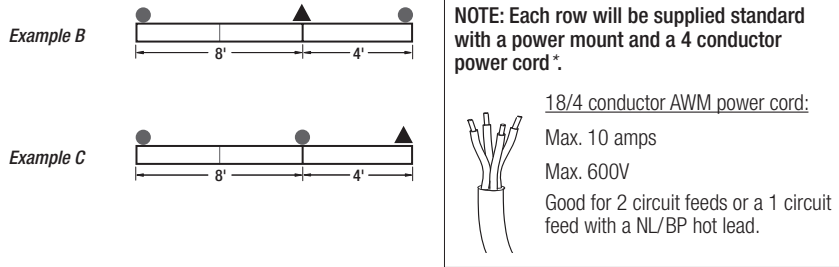
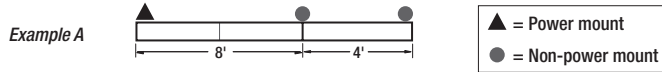

Emergency Circuit (EM), Night Light (NL) or Battery Pack (BP) Option

Modules are available with optional EM/NL circuit or BP. EM/NL/BP each power one 4ft end section of a module. To vary placement in a row, modules installed with EM/NL/BP can be reversed 180° as shown below in the 4ft and 8ft modules.

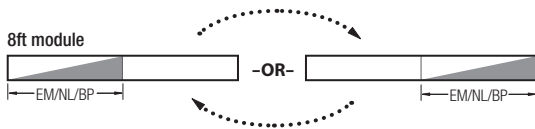
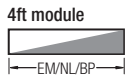

Emergency Circuit (EM), Night Light (NL) and Battery Pack (BP) placement in rows

Placement of EM/NL/BP modules is variable throughout a row. *See examples below of EM/NL/BP installed in 20ft rows.*

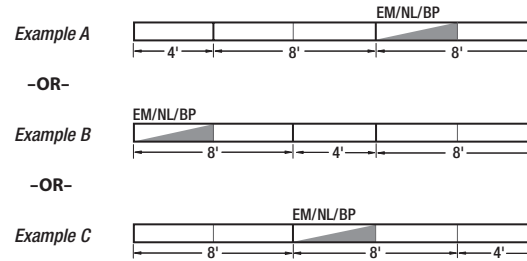

IMPORTANT: Whenever longer rows are made up of both 4' and 8' modules, EM/NL/BP sections will always be installed in 8' modules. If specific site restrictions require EM/NL/BP sections to be installed in 4' sections, please contact the factory.

Power feeds for rows installed with Night Light (NL) or Battery Pack (BP)

Every NL/BP module will be supplied with an additional 4 conductor power cord and power mount to enable variable power locations, as shown in the examples below.

For NL and BP installation, power can be installed adjacent to normal power or in a separate location.

See examples A and B below.

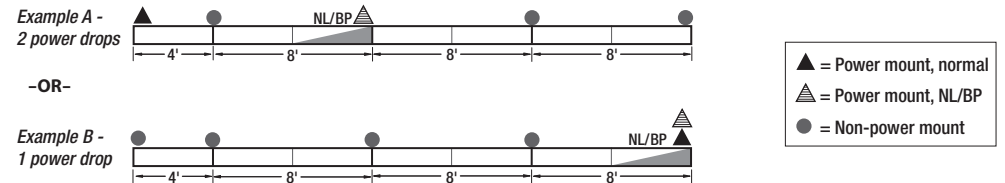

Power feeds for rows installed with Emergency Circuit (EM)

Every EM module will be supplied with an additional 4 conductor power cord and power mount to enable variable power locations, as shown in the examples below.

For EM installation, in all instances, code restrictions require two separate power drops, one for normal power and one for EM power. EM power must be installed in a location different than the normal power. *See example A below.*

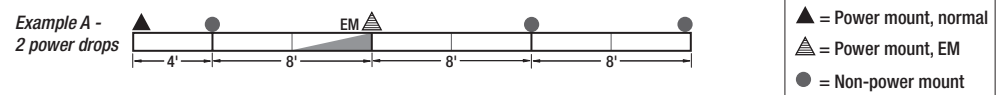

! ATTENTION: Install in accordance with national and local building and electrical codes. Page 2

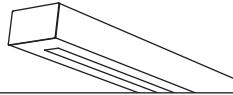

Row Configurations

Module Lengths

Chopstick™ wall systems are available in nominal 4ft and 8ft modules. Exact overall module lengths are shown to the right (without endcaps).

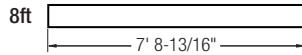
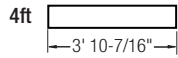

Indicates overall nominal length of module. Module lengths do not include endcaps. Endcap dimensions are shown below.

Endcaps

Overall row lengths do not include endcaps. Add two endcaps to the overall length of each row.

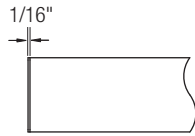

Mount Spacing

- Variable wall mount brackets can be positioned within 2"-4" of fixture end or joint.
- Maximum distance between mounts is 48".

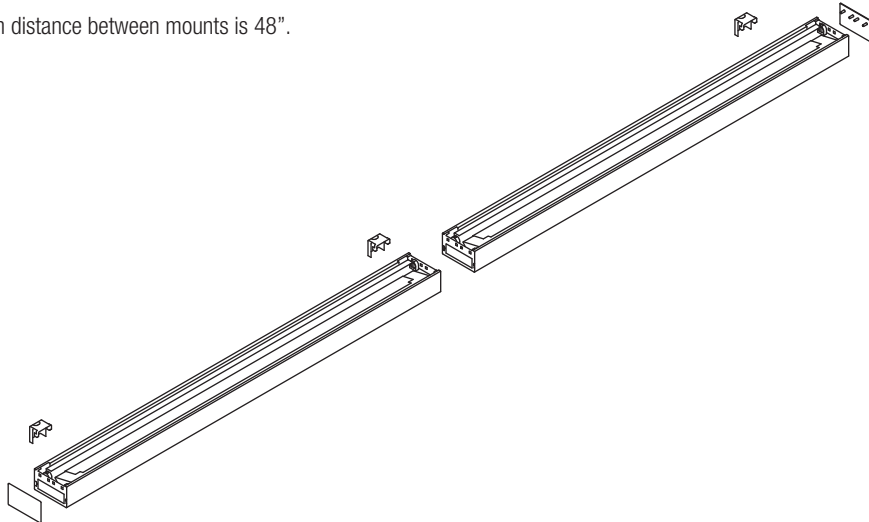

Row Configurations

The table below indicates how nominal 4ft and 8ft modules can be combined to create continuous rows of various lengths. Modules can be combined in any order.

| Nominal Row Length | Number of Modules Required | | Installed Row Length (not including endcaps) |
|--------------------|----------------------------|-----|--|
| | 4' | 8' | |
| 4' | 1x | | 3' 10-7/16" |
| 8' | | 1x | 7' 8-13/16" |
| 12' | 1x | 1x | 11' 7-1/4" |
| 16' | | 2x | 15' 5-5/8" |
| 20' | 1x | 2x | 19' 4-1/16" |
| 24' | | 3x | 23' 2-7/16" |
| 28' | 1x | 3x | 27' 0-7/8" |
| 32' | | 4x | 30' 11-1/4" |
| 36' | 1x | 4x | 34' 9-11/16" |
| 40' | | 5x | 38' 8-1/16" |
| 44' | 1x | 5x | 42' 6-1/2" |
| 48' | | 6x | 46' 4-7/8" |
| 52' | 1x | 6x | 50' 3-5/16" |
| 56' | | 7x | 54' 1-11/16" |
| 60' | 1x | 7x | 58' 0-1/8" |
| 64' | | 8x | 61' 10-1/2" |
| 68' | 1x | 8x | 65' 8-15/16" |
| 72' | | 9x | 69' 7-5/16" |
| 76' | 1x | 9x | 73' 5-3/4" |
| 80' | | 10x | 77' 4-1/8" |
| 84' | 1x | 10x | 81' 2-9/16" |
| 88' | | 11x | 85' 0-15/16" |
| 92' | 1x | 11x | 88' 11-3/8" |
| 96' | | 12x | 92' 9-3/4" |
| 100' | 1x | 12x | 96' 8-3/16" |

! ATTENTION: Install in accordance with national and local building and electrical codes. Page 3

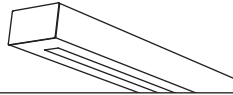

Power Feed

Power for the entire row can be placed at either end or any joint. *See examples below.*

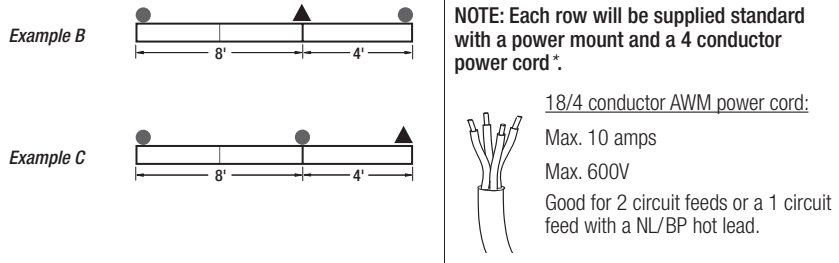
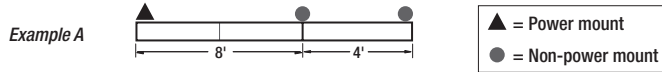

Emergency Circuit (EM), Night Light (NL) or Battery Pack (BP) Option

Modules are available with optional EM/NL circuit or BP. EM/NL/BP each power one 4ft end section of a module. EM/NL/BP sections will always be installed on the right side (when facing wall).

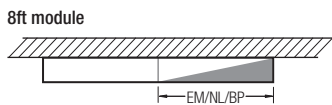
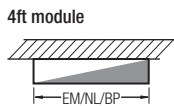

Emergency Circuit (EM), Night Light (NL) and Battery Pack (BP) placement in rows

Placement of EM/NL/BP modules is variable throughout a row. *See examples below of EM/NL/BP installed in 20ft rows.*

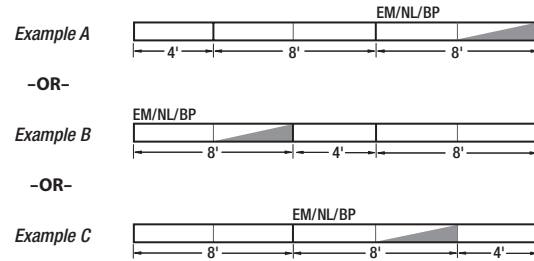

IMPORTANT: Whenever longer rows are made up of both 4' and 8' modules, EM/NL/BP sections will always be installed in 8' modules. If specific site restrictions require EM/NL/BP sections to be installed in 4' sections, please contact the factory.

Power feeds for rows installed with Night Light (NL) or Battery Pack (BP)

Every NL/BP module will be supplied with an additional 4 conductor power cord and power mount to enable variable power locations, as shown in the examples below.

For NL and BP installation, power can be installed adjacent to normal power or in a separate location.

See examples A and B below.

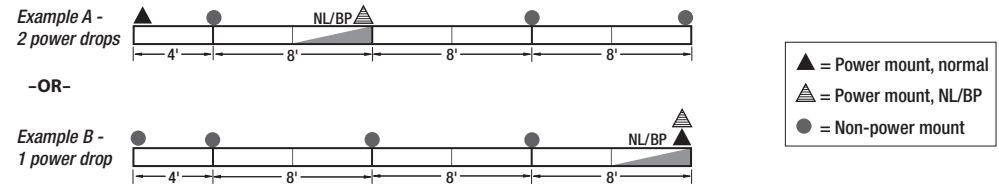

Power feeds for rows installed with Emergency Circuit (EM)

Every EM module will be supplied with an additional 4 conductor power cord and power mount to enable variable power locations, as shown in the examples below.

For EM installation, in all instances, code restrictions require two separate power drops, one for normal power and one for EM power. EM power must be installed in a location different than the normal power. *See example A below.*

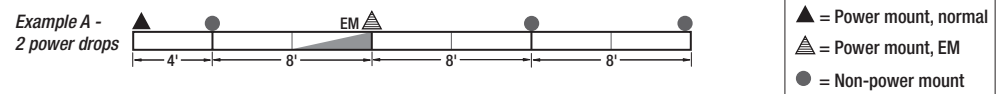

! ATTENTION: Install in accordance with national and local building and electrical codes. Page 4