



The Gardco ClearScape LED luminaires feature an architecturally stylish design that will complement your application's visual landscape. ClearScape offers unparalleled photometric performance, significant savings over HID, and is available with the latest in energy saving control options.

Project: _____
 Location: _____
 Cat.No: _____
 Type: _____
 Lamps: _____ Qty: _____
 Notes: _____

Ordering guide

Example: CSFM-A13-740-A33-SLF-120-FS1-SP2-MG

Luminaire	Configuration (nominal lumens)	Color Temperature	Distribution	Mounting	Voltage	Options				Finish					
						Dimming Controls ^{1,5}	Fusing	Surge Protection	Other Options						
CSFM	A11 16,000	730 70CRI	A33 Assymetric	SLF Slip Fitter	120 120V	None Leave blank (0-10V dimming driver standard)	None Leave blank	Blank 10kV / 10kA (standard)	None Leave blank	BK Black					
	A12 18,000	3000K	33° Flood	Mount (fits on 2-3/8" to 3" O.D. tenon, wires through slip fitter)	208 208V										
	A13 20,000	740 70CRI	(NEMA 6x5)	TRN ⁸ Trunnion Mount (3.28' or 1m cord exits luminaire)	240 240V										
	A14 24,000	4000K	SPT ⁷ Spot (12° Round) (NEMA 2x2)	UNV Universal 120-277V	277 277V										
	A15 30,000	750 70CRI	5000K	HVU Universal 347-480V	347 347V										
					480 480V										
					UNV Universal 120-277V						DLEA ^{1,2,5,10} Dimming Leads Externally Accessible (controls by others)	FS1 ⁴ Single Fuse (120V, 277V, or 347V)	SP2 20kV / 10kA (option)	PCB ^{2,3,4,5} Photocontrol Button	BZ Bronze
														ICL ⁷ Internal Concentric Glare Louver	DG Dark Gray
														TT5 ^{2,5,8,9} Tool-less NEMA Twist-lock 5-pin receptacle	MG Medium Gray
															WH White
									OC ⁶ Optional Color Specify optional color or RAL, contract factory						
									SC ⁶ Special Color Must supply color chip, requires factory quote						

1. Choose only 1 option: either DLEA or FAWS.
2. For DLEA option luminaire has 0-10V dimming wires exiting the luminaire for dimming controls by others. DLEA not available with PCB or TT5 - choose one of the three options.
3. PCB available with 120V or 208V or 240V or 277V.
4. For Fusing and PCB must specify applicable specific input voltage, not available with UNV or HVU.
5. 0-10V dimming driver standard.
6. Must contact factory prior to ordering - these items are ETO Specials.
7. ICL not available with SPT (does not fit on optical plate).
8. TT5 not available with TRN Trunnion Mount.
9. Use of photoelectric cell (by others) or shorting cap (by others) is required to ensure proper illumination.

CSFM ClearScape LED floodlight, medium

CSFM medium floodlight

Accessories¹ – Ordering guide (Ordered separately, field installed, specify finish at placeholder F)

Shielding and Lenses	Mounting – Slip Fitter mount	Mounting – Trunnion mount
WG-CSFM Wire Guard SG-CSFM Stone Guard BD-CSFM Barn Doors (Black finish standard)	WMB-16.5-(F) Wall Mounting Bracket SMT-2-(F) Surface Mount Tenon JB-VMT-(F) Junction Box w/ SMT-2	BP-(F) Surface Mount Base Plate

1. Consult Signify to confirm whether specific accessories are BAA-compliant.

Dimensions – ClearScape Medium (CSFM)

Slip Fitter Mount

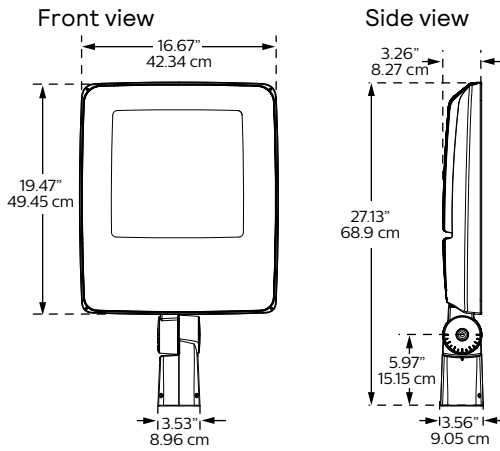

Weight: 41 Lbs (18.6 Kg)

Trunnion Mount

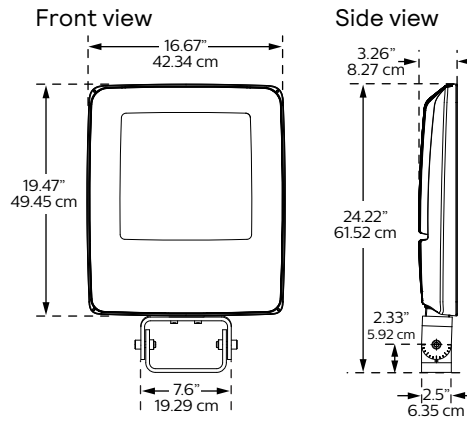

Weight: 39 Lbs (17.7 Kg)

EPA Chart

Mounting	Effective Projected Area (EPA-ft ²)		
	Single: 0° Aim	Single: 45° Aim	Single: 90° Aim
SLF	0.23	1.71	3.04
TRN	0.22	1.67	2.95

Slip Fitter and Trunnion Aiming Diagram

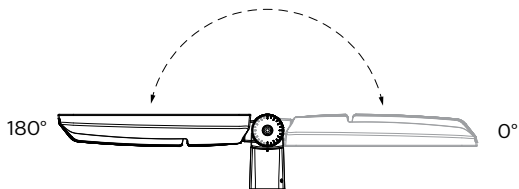

Drill Template – Trunnion Mount

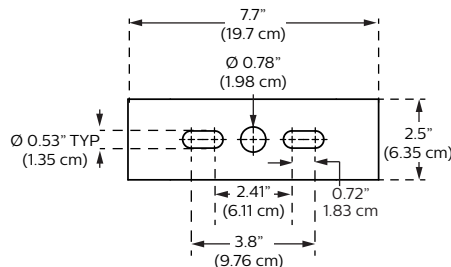

Recommended Bolt Size: 1/2"

CSFM ClearScape LED floodlight, medium

CSFM medium floodlight

Optical Distribution Diagrams

A33 Asymmetric 33° Flood (NEMA 6x5)

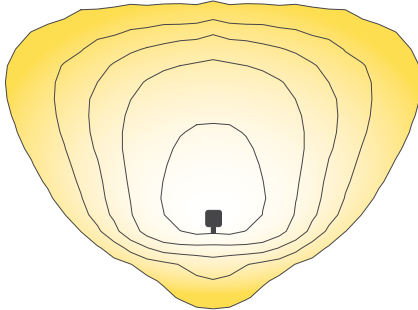

30' or 9.14m mounting height, 30° tilt

Applications include: area lighting, storage yards, transportation terminals, utility sub-stations, large facades, wall washing, large structures/monuments/statues, trees with large canopies.

SPT Spot 12° Round (NEMA 2x2)

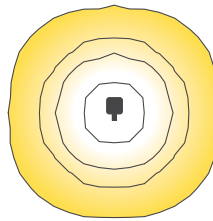

20' or 6.10m setback, 0° tilt

Applications include: flags, tighter spotlighting, accenting, taller columns, tighter scalloping, taller structures/monuments/statues, tallest trees.

RSP Rectangular Spot (NEMA 3x3)

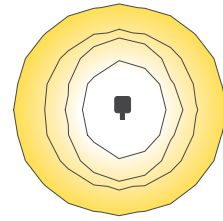

15' or 4.57m setback, 0° tilt

Applications include: flags, spotlighting, accenting, columns, scalloping, structures/monuments/statues, taller trees.

RMF Rectangular Medium Flood (NEMA 7x4)

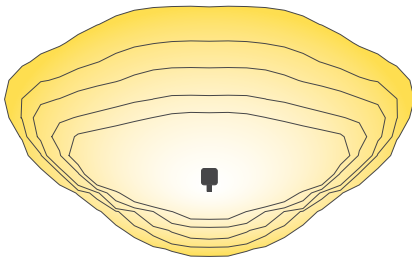

10' or 3.05m setback, 30° tilt

Applications include: building entrances and exits, security lighting, checkpoints and inspection stations, signs, ornamental trees and shrubs

RNF Rectangular Narrow Flood (NEMA 7x5)

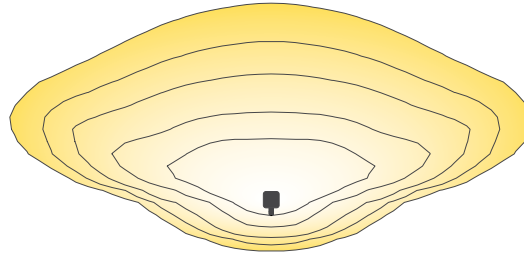

15' or 4.57m setback, 45° tilt

Applications include: facades, wall grazing, signs (especially larger and more rectangular)

Field Adjustable Wattage Selector (FAWS) Multiplier Chart

FAWS Position	Typical Lumens and System Wattage Multiplier
1	25%
2	50%
3	55%
4	65%
5	75%
6	80%
7	85%
8	90%
9	95%
10	100%

NOTE: Actual performance may vary due to LED and driver tolerances.

CSFM ClearScape LED floodlight, medium

CSFM medium floodlight

Technical Data

Ordering Code	Color Temp.	Avg. System Watts (W)	SPT		RSP		A33		RNF		RMF	
			Lumen Output	Efficacy (LPW)	Lumen Output	Efficacy (LPW)	Lumen Output	Efficacy (LPW)	Lumen Output	Efficacy (LPW)	Lumen Output	Efficacy (LPW)
CSFM-A11-730	3000	120	13,912	116	13,912	116	14,185	119	13,878	116	14,163	118
CSFM-A12-730	3000	135	15,651	116	15,651	116	15,958	118	15,613	116	15,933	118
CSFM-A13-730	3000	157	18,131	115	18,131	115	18,486	118	18,087	115	18,457	117
CSFM-A14-730	3000	180	20,669	115	20,669	115	21,074	117	20,619	115	21,041	117
CSFM-A15-730	3000	246	26,872	109	26,872	109	27,399	111	26,807	109	27,357	111

CSFM-A11-740	4000	120	14,920	125	15,002	125	15,213	127	14,884	124	15,189	127
CSFM-A12-740	4000	135	16,786	125	16,877	125	17,115	127	16,745	124	17,088	127
CSFM-A13-740	4000	157	19,445	124	19,551	124	19,826	126	19,398	123	19,795	126
CSFM-A14-740	4000	180	22,167	123	22,288	124	22,602	126	22,114	123	22,567	126
CSFM-A15-740	4000	246	28,821	117	28,978	118	29,386	119	28,751	117	29,340	119

CSFM-A11-750	5000	120	14,920	125	15,002	125	15,213	127	14,884	124	15,189	127
CSFM-A12-750	5000	135	16,786	125	16,877	125	17,115	127	16,745	124	17,088	127
CSFM-A13-750	5000	157	19,445	124	19,551	124	19,826	126	19,398	123	19,795	126
CSFM-A14-750	5000	180	22,167	123	22,288	124	22,602	126	22,114	123	22,567	126
CSFM-A15-750	5000	246	28,821	117	28,978	118	29,386	119	28,751	117	29,340	119

Values from photometric tests performed in accordance with IESNA LM-79 and are representative of the configurations shown. Actual performance may vary due to installation and environmental variables, LED and driver tolerances, and field measurement considerations. It is highly recommended to confirm performance with a photometric layout.

NOTE: Some data may be scaled based on tests of similar (but not identical) luminaires. Contact factory for configurations not shown.

CSFM ClearScape LED floodlight, medium

CSFM medium floodlight

Luminaire Option and Accessory details

Barn Doors (BD)

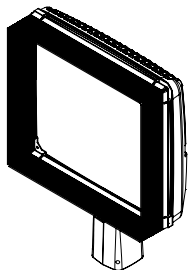

Stone Guard (SG)

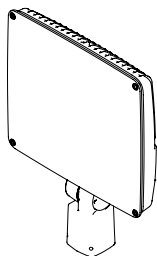

Wire Guard (WG)

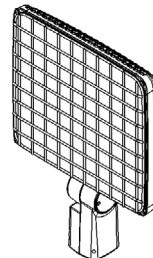

Mounting accessory details – Slip Fitter

WMB-16.5-(F)

Wall Mounting Bracket

2-3/8" O.D. vertical tenon welded to extruded aluminum arm with removable end cap for wiring. Arm is bolted to a cast aluminum plate that has four 5/8" diameter mounting holes.

Suitable for mounting single luminaire only.

Mounting hardware by others.

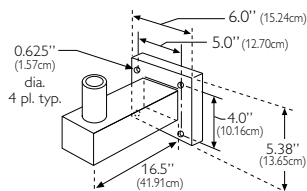

SMT-2-(F)

Surface Mounted Tenon

2-3/8" O.D. aluminum tenon welded to a flat aluminum plate with four 1/2" diameter mounting holes.

Single floodlight may be pad mounted or wall mounted.

Mounting hardware by others.

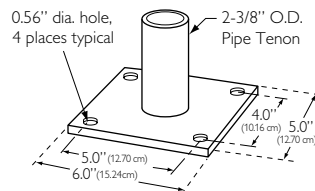

JB-VMT-(F)

Junction Box with SMT-2

For mounting to flat surfaces when using surface mount conduit.

Box has four 1/2" pipe entrances.

1/2" NPS.

Mounting hardware by others.

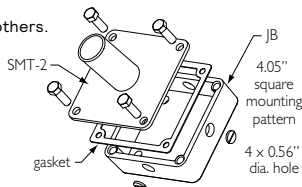

Mounting accessory details – Trunnion Mount

BP-(F) Surface Mount Base Plate

Flat aluminum plate with four 1/2" diameter mounting holes. Single floodlight may be pad mounted or wall mounted. Mounting hardware by others.

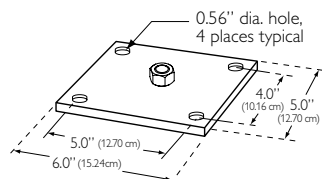

CSFM ClearScape LED floodlight, medium

CSFM medium floodlight

Specifications

Housing and Heat Sink

Single piece low copper die cast Aluminum alloy (A413) for high resistance to corrosion, low profile for a sleek design with low EPA. Housing also acts as heat sink, designed to ensure high efficacy and superior cooling by natural convection. Integral cast-in heat sink fins are oriented vertically to discourage debris accumulation and promote self-cleaning, further improving heat dissipation. Air flow pattern always close to LEDs and driver optimizing their efficiency and life. Does not use any cooling device with moving parts (only passive cooling).

Mounting

Up tilt aiming and down tilt aiming possible with both mounting options. cULus Listed as suitable for mounting within 4' or 1.2m of the ground.

SLF: Adjustable Slip Fitter with AWG 16-3 wires exiting through the Slip Fitter. Integral splice compartment for field wiring with cULus Wet Location rated access cover with seal around entire perimeter. Slip Fitter made of low copper die cast Aluminum alloy (A360) for high resistance to corrosion, adjustable knuckle has 5 degree aiming increments with integral interlocking teeth and bolt to secure aiming in place, integral cast-in aiming marks. Fits on a range of tenons from 2-3/8" to 3" (60.3mm to 76.2mm) O.D.

TRN: Adjustable Trunnion with 3.28' (1m) of AWG 16-3 STOOV cord (or AWG 16-5 if DLEA external control option is selected) exiting the luminaire through IP66 rated cord seal. Trunnion made of high strength steel, galvanized and painted for high resistance to corrosion, wide range of adjustment (no minimum aiming increments) with bolts and lock washers to secure aiming in place, integral aiming marks every 15 degrees.

IP Rating

IP66 rated luminaire in all aiming positions including up tilt aiming per ANSI C136.37 with seal around entire perimeter of the lens and seal around entire perimeter of the electrical / driver compartment. IP66 rating includes when PCB or TT5 NEMA twist-lock options are installed.

Lens

Single piece heat and impact resistant flat soda-lime tempered glass lens that provides an all-glass edge-to-edge front for a modern design aesthetic. Clear glass in front of LED light engines with black silk screen on inside of remaining lens surface to minimize glare and provide uniform visual transition to the housing. Single piece molded silicone gasket around entire perimeter overlaps securely on housing rib with optimum compression from lens forming IP66 seal. Captive corrosion resistant stainless-steel screws enable removal of lens if required to access electrical components, black oxide screws visually blend in with lens' black silk screen. Ceramic washers cushion screws against glass lens and help ensure proper gasket compression for reliable seal. Lens secured with tether to prevent accidental dropping or disengagement.

IK Rating

IK07 high impact resistance rating for lens.

Light Engine

Composed of 3 main components: LED Module, Optical System, Driver. Electrical components are RoHS compliant. LEDs tested by ISO 17025 2005 accredited lab in accordance with IESNA LM-80 guidelines, extrapolations in accordance with IESNA TM-21. Metal core board ensures greater heat transfer and longer lifespan.

LED Module: Composed of high performance white LEDs. Color temperature as per ANSI/NEMA bin 3000K nominal (3045K +/-175K) or 4000K nominal (3985K +/- 275K) or 5000K nominal (5029K +/- 283K), all CRI 70 min. / 75 typical.

Optical System: Composed of high performance UV stabilized optical grade polymer refractor lenses to achieve desired distribution optimized to get maximum spacing, target lumens and a superior lighting uniformity. Performance shall be tested per LM-63, LM-79 and TM-15 (IESNA) certifying its photometric performance.

Driver: High power factor of 90% min. Electronic driver, operating range 50/60 Hz. Auto adjusting universal voltage input from 120 to 277 or 347 to 480 VAC rated for both application line to line or line to neutral, Class I, THD of 20% max. The current supplying the LEDs will be reduced by the driver if the driver experiences internal overheating as a protection to the LEDs and the electrical components. Output is protected from short circuits, voltage overload and current overload. Automatic recovery after correction. Standard built in driver surge protection of 2.5kV (min). Driver enables setting LED drive current to meet your specific total wattage, lumen output and/or efficacy needs - ETO Specials, contact factory.

Integrated Features

Please note these integrated features always come with luminaire standard at no additional cost. 0-10V dimming driver included as standard, dimming leads pre-wired to Dimming Controls options except when DLEA external controls option is selected.

SP1: Surge protection device tested in accordance with ANSI/IEEE C62.45 per ANSI/IEEE C62.41.2 Scenario I Category C High Exposure 10kV/10kA waveforms for Line-Ground, Line-Neutral and Neutral-Ground. Enhanced surge protection device SP2 20kV/10kA available as an option

Controls Options

Please note that other controls can be integrated as ETO Specials - contact factory.

DLEA: 0-10V dimming driver's dimming wires are externally accessible for connecting dimming controls by others.

FAWS: Field Adjustable Wattage Selector, pre-set to the highest position, can be easily switched in the field to the required position. This reduces total luminaire wattage consumption and light level - see FAWS multiplier chart for more details.

Note: It is not recommended to use FAWS with other dimming or controls; if you do, set the switch to position 10 (maximum output) to enable the other dimming or controls. Switching FAWS to any position other than 10 will disable the other dimming or controls.

Luminaire Options

FS1: Fusing, single (120, 277 or 347VAC) installed in electrical compartment

FS2: Fusing, double (208, 240 or 480VAC) installed in electrical compartment

FS3: Fusing, Canadian Double Pull (208, 240 or 480VAC) installed in electrical compartment.

SP2: 20kV / 10kA surge protection device that provides extra protection beyond the standard SP1 10kV/10kA level.

PCB: Photocell Button (a.k.a. button photoeye).

ICL: Internal Concentric Glare Louver reduces glare and increases visual comfort. Shields are installed internally in the factory and do not disrupt the overall aesthetic of the luminaire. ICL not available with SPT optic (does not fit).

TT5*: Tool Less orientable twist-lock receptacle with 5 pins enabling dimming, can be used with a twist-lock photoelectric cell or a shorting cap. TT5 not available with TRN Trunnion.

*Use of photoelectric cell or shorting cap is required to ensure proper illumination.

Luminaire Useful Life

Refer to IES files for energy consumption and delivered lumens for each option. Based on ULSTMT in situ thermal testing in accordance with UL1598 and UL8750, Signify System Reliability Tool, Advance driver data and LED manufacturer LM-80/TM-21 data, expected to reach 100,000 + hours with L70 lumen maintenance @ 25°C. Luminaire Useful Life accounts for LED lumen maintenance AND all these additional factors including: LED life, driver life, PCB substrate, solder joints, on/off cycles, burning hours and corrosion.

Wiring

#16 AWG wires from the primary circuit, located inside the housing. Due to the inrush current that occurs with electronic drivers, recommend using a time-delay or slow blow fuse to avoid unwanted fuse blowing (false tripping) that can occur with normal or fast acting fuses.

Hardware and Seals

All exposed hardware shall be stainless steel and/or corrosion resistant and captive. All seals and sealing devices are made and/or lined with EPDM and/or silicone and/or rubber.

Finish

Color in accordance with the AAMA 2604 standard. Application of polyester powder coat paint (2.5 mils/62.5 microns) with +/- 1 mils/24 microns of tolerance. The thermosetting resins provides a discoloration resistant finish in accordance with the ASTM D2244 standard, as well as luster retention in keeping with the ASTM D523 standard and humidity proof in accordance with the ASTM D2247 standard. The surface treatment achieves a minimum of 1000 hours for salt spray corrosion resistant finish in accordance with the ASTM B117 standard. RAL and custom color matching available - must contact factory prior to ordering, these are ETO Specials.

LED Products Manufacturing Standard

The electronic components sensitive to electrostatic discharge (ESD) such as light emitting diodes (LEDs) are assembled in compliance with

CSFM ClearScape LED floodlight, medium

CSFM medium floodlight

Specifications (cont.)

IEC61340-5-1 and ANSI/ESD S20.20 standards to eliminate ESD events that could decrease the useful life of the product.

Vibration Resistance

Luminaire meets the ANSI C136.31-2018 specifications for Bridge / Overpass for both Slip Fitter and Trunnion, tested by independent lab over 100,000 cycles in all three axes.

Certifications and Compliance

cULus Listed for Canada and USA, per UL1598 and UL8750, including suitable for mounting within 4' or 1.2m of the ground. Configurations are DesignLights Consortium qualified, consult DLC QPL Qualified Products List for more details. Luminaire complies with or exceeds the following ANSI C136 standards: .2, .3, .10, .15, .21, .22, .24,

.25, .31, .32, .37, .41. Entire luminaire is rated for operation in ambient temperature of -40°C (-40°F) up to +40°C (+104°F). Controls options enable compliance with Outdoor lighting energy codes including ASHRAE 90.1, California Title 24, and IECC.

Limited Warranty

5-year limited warranty. See signify.com/warranties for details and restrictions.

Predicted Lumen Depreciation Data

Ambient Temperature °C	Drive Current	Calculated L ₇₀ Hours	L ₇₀ Per TM-21	Lumen Maintenance % @ 60,000 hours
25°C	up to 1200 mA	>100,000 hours	>60,000 hours	99%

Predicted performance derived from LED manufacturer's data and engineering design estimates, based on IESNA LM-80 methodology. Actual experience may vary due to field application conditions. L₇₀ is the predicted time when LED performance depreciates to 70% of initial lumen output. Calculated per IESNA TM21-11. Published L₇₀ hours limited to 6 times actual LED test hours.

Buy American Act of 1933 (BAA):

This product is manufactured in one of our US factories and, as of the date of this document, this product was considered a commercially available off-the-shelf (COTS) item meeting the requirements of the BAA. This BAA designation hereunder does not address (i) the applicability of, or availability of a waiver under, the Trade Agreements Act, or (ii) the "Buy America" domestic content requirements imposed on states, localities, and other non-federal entities as a condition of receiving funds administered by the Department of Transportation or other federal agencies. Prior to ordering, please visit www.signify.com/baa to view a current list of BAA-compliant products to confirm this product's current compliance.

