

System Overview

These instructions review how to install Jump wall fixtures. Jump 4ft and 8ft modules can be installed as individual standalone units, or they can be joined together to create continuous runs. The graphic below shows the components required to install a typical run of Jump wall fixtures.

Jump joint kit(s)*

- A/C mounting bracket (x1)
- Break apart joiner aligner (x1)
- #8-32 x 1/2" screw (x2)
- #8-32 Hex Nut (x2)
- Gasket (x1)
- Power Plate (x2)
- Plug 1/2 (x2)

*NOTE: 1 kit required for each in-run joint.

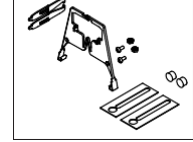

Wall mount kit(s)*

- 1/4-20 x 5/8 hex washer screw (x1)
- 1/4-20 x 5/8 screw (x1)
- 10-24 hex lock nut (x1)
- 1/4 countersink toothed washer (x1)
- Wall mount cover (x1)
- Fixture mount bracket (x1)
- Wall arm bracket (x1)

*NOTE: 2 kits required for each run (one for each end).

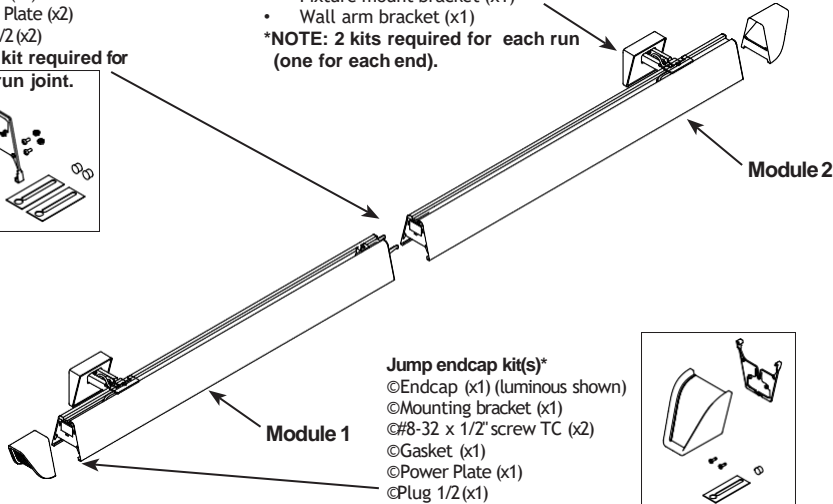
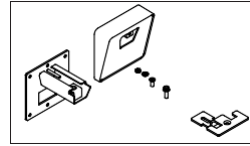

Jump endcap kit(s)*

- Endcap (x1) (luminous shown)
- Mounting bracket (x1)
- #8-32 x 1/2" screw TC (x2)
- Gasket (x1)
- Power Plate (x1)
- Plug 1/2 (x1)

*NOTE: 2 kits required for each run (one for each end).

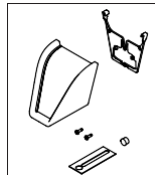

TOOLS REQUIRED: Philips screwdriver, 3/8" nut driver.

Module Lengths

Jump wall systems come in 4ft and 8ft modules. Overall module lengths are shown below. Module lengths do not include endcaps.

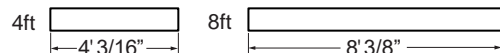

Indicates overall length of fixture (excluding endcaps)

Endcaps

Add two endcaps to the length of each run.



Mount Spacing

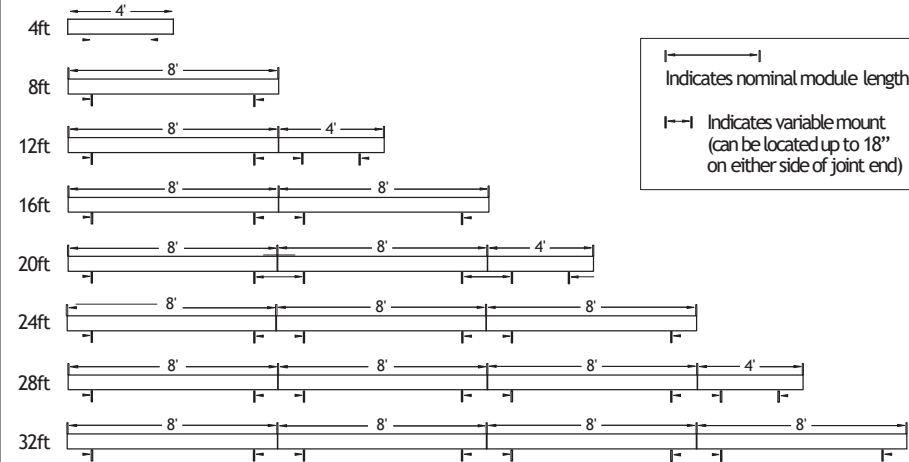

Run Configurations

The tables below indicate how 4ft and 8ft modules can be combined to create continuous runs of various lengths.

Nominal Row Length	Number of Modules Required		Installed Row Length (not including end caps)
	4'	8'	
4'	1x		4' - 3/16"
8'		1x	8' - 3/8"
12'	1x	1x	12' - 9/16"
16'		2x	16' - 3/4"
20'	1x	2x	20' - 15/16"
24'		3x	24' 1 - 1/16"
28'	1x	3x	28' 1 - 1/4"
32'		4x	32' 1 - 7/16"
36'	1x	4x	36' 1 - 5/8"
40'		5x	40' 1 - 13/16"
44'	1x	5x	44' 1"
48'		6x	48' 2 - 3/16"

Nominal Row Length	Number of Modules Required		Installed Row Length (not including end caps)
	4'	8'	
52'	1x	6x	52' 2 - 3/8"
56'		7x	56' 2 - 9/16"
60'	1x	7x	60' 2 - 11/16"
64'		8x	64' 2 - 7/8"
68'	1x	8x	68' 3 - 1/16"
72'		9x	72' 3 - 1/4"
76'	1x	9x	76' 3 - 7/16"
80'		10x	80' 3 - 5/8"
84'	1x	10x	84' 3 - 13/16"
88'		11x	88' 3"
92'	1x	11x	92' 4 - 3/16"
96'		12x	96' 4 - 3/8"
100'	1x	12x	100' 4 - 1/2"

*Overall run lengths provided do not include endcaps. Add two endcaps to the overall length of each run.

! ATTENTION: Install in accordance with national and local building and electrical codes.

1 Prepare Fixtures

Arrange boxed fixtures on floor in specified mounting locations; remove fixtures from boxes.

2 Attach Brackets to Wall

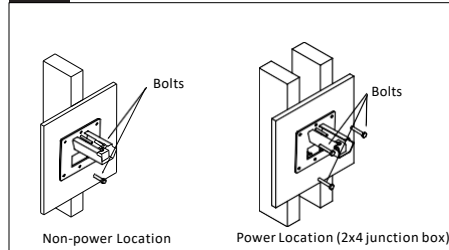

Attach brackets to wall using appropriate hardware (1/4 fastener recommended). Insure structure can support the weight of the fixture at 3.5lbs/ft. Install using two center holes for non-power locations and use 4 outer holes for power locations. Power locations require a vertically oriented 2 x4 recessed utility box (supplied by others). Use a spirit level and adjust mounting screws to level brackets.

Level the bracket by loosening or tightening the top screw or screws that hold the bracket to the structure.

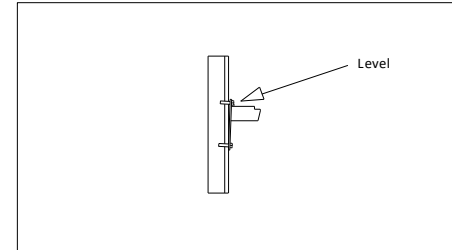

3 Complete Electrical Connection in Wall

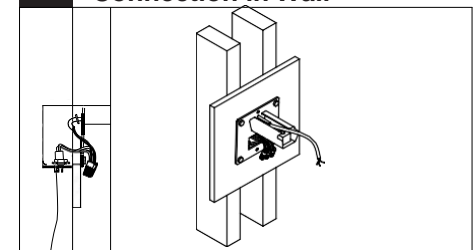

(Power locations only) Feed power cable through hole in mounting bracket. Complete electrical connection to junction box through square cut out in mounting bracket.

4 Slide on Wall Covers

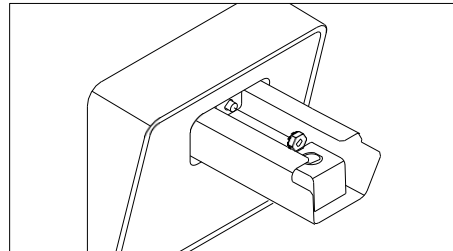
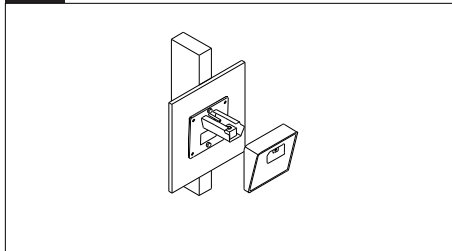

Slide on Wall covers and use supplied #8 lock-nut to secure to cantilever bracket (non-power mount shown).

5 Attach Fixture Hanging Brackets

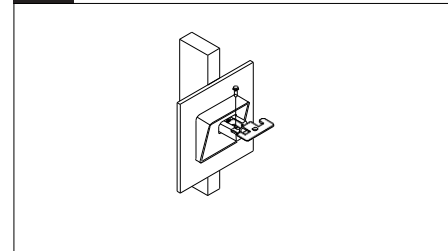

Attach fixture hanging brackets to cantilever brackets using supplied -20 bolts. Do not fully tighten.

6 Slide Power Plates into Fixture

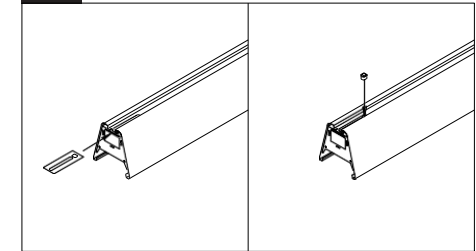

On the floor, slide power plates into fixture ends. Attach supplied bushings in power locations and plugs in non-power locations.



ATTENTION: Install in accordance with national and local building and electrical codes.

7 Install Mounting Bracket

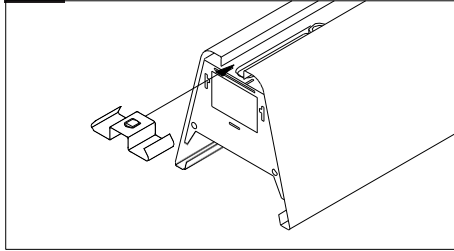

8 Attach the Fixture to the Bracket

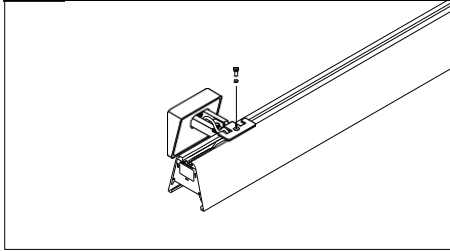

Raise fixture to brackets and use the supplied countersunk screw with countersunk washer to attach the fixture to the bracket. Adjust fixture hanging brackets so fixture is flush with cantilever arm and tighten.

9 Run and Secure Power Cables

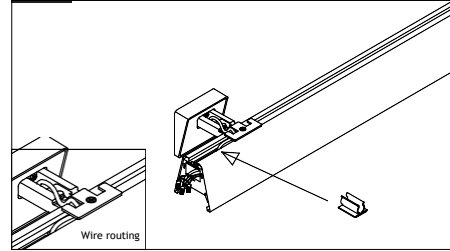

Run power cable down fixture channel and through power plate at the end of the fixture. Secure power cable into fixture channel using supplied cable clips at 4 increments.

Complete power connections using cut out in end of fixture.

10 Attach Joiner Aligner Brackets

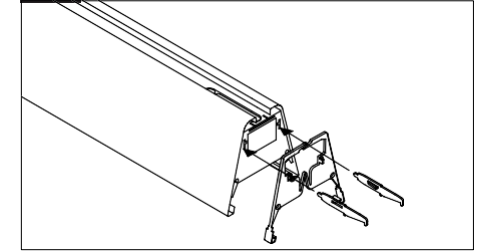

On the floor, slide variable mount bracket into next fixture in run. Attach joiner-aligner brackets into opposite side.

11 Suspend and Join Additional Fixtures to Create Row

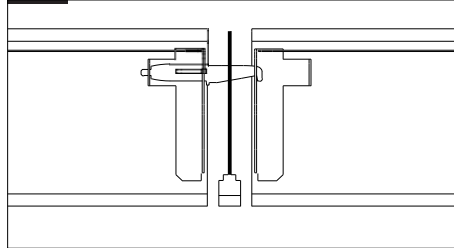

Raise next fixture to cantilever bracket and insert the joiner aligners into the corresponding slots on the already installed fixture.

Attach variable mount bracket to next cantilever arm as per steps 6-9.

12 Complete Power Connections

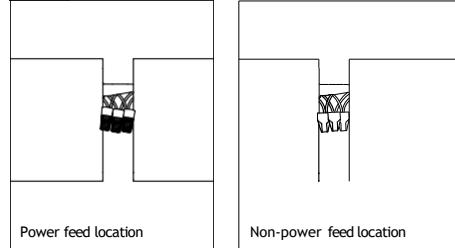

Complete power connections between fixtures.

13 Finishing

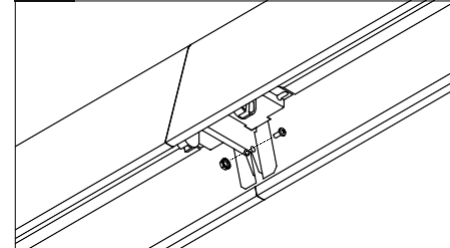

Join fixtures using supplied #8 screws and lock-nuts. Repeat steps 8-12 for each fixture in run.

14 Attach End Cap

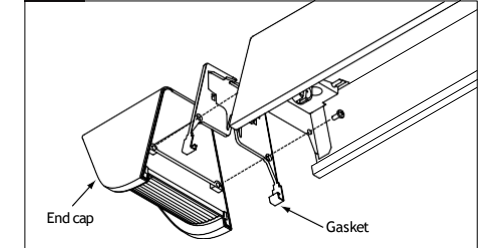

Snap on the gasket to the end of the fixture and attach end caps using supplied #8 screws.

This equipment has been tested and found to comply with the limits for a Class A digital device, pursuant to part 15 of the FCC Rules. These limits are designed to provide reasonable protection against harmful interference when the equipment is operated in a commercial environment. This equipment generates, uses, and can radiate radio frequency energy and, if not installed and used in accordance with the instruction manual, may cause harmful interference to radio communications. Operation of this equipment in a residential area is likely to cause harmful interference in which case the user will be required to correct the interference at his own expense.

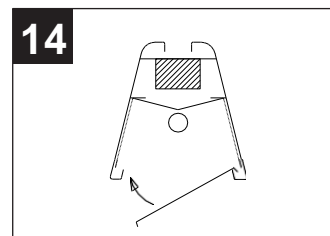

Install lenses as shown.

! ATTENTION: Install in accordance with national and local building and electrical codes.

Sensor in Rows

Single Sensor Controlling Whole Row

1. Purple & brown (or purple & grey/pink) control wires **MUST** be connected between fixtures.

Note :

- A maximum of 8 drivers can be wired to 8 sensors; confirm fixture driver count with factory.



Multiple Sensors Controlling Separates Zones in a Row

2. Purple & brown (or purple & grey/pink) control wires **MUST NOT** be connected between zones.

Notes :

- A maximum of 8 drivers can be wired to one sensor; confirm fixture driver count with factory.
- Only one sensor is allowed on a wired zone. (Sensors can be paired together wirelessly via a mobile app).

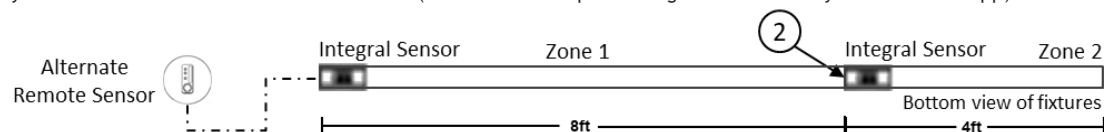

Sensor Spacing

- For correct operation, sensor should be placed a minimum distance of 8ft apart.
- Wireless sensor should be placed no further than 40ft apart for good wireless signal connection.

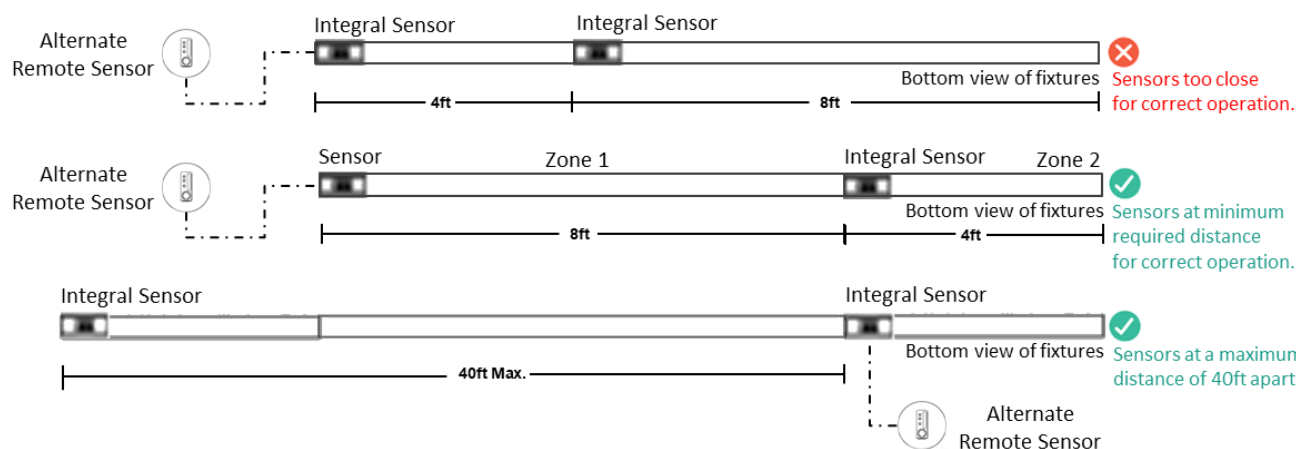

Important Consideration When Using Sensor in a Row

- For fixtures with wireless sensors (CS, SB or RA options): **DO NOT** connect fixture purple and brown (or purple & grey/pink) control wires to an external dimming switch. Fixture mains wiring should not be connected to a circuit with an external on/off switch.
- For best aesthetic condition, place sensors at ends of row only so as not to break the continuous lens.
- For better occupancy coverage in longer rows, sensors may be placed mid run, but keep in mind this will break the continuous lens into discrete sections. Alternatively, remote sensors may be used, note the same wiring rules will apply.



ATTENTION: Install in accordance with national and local building and electrical codes.

Occupancy Sensor Coverage:

Note: Longer dimension of detection area (Y1, Y2) is parallel to longer dimension of the luminaire.

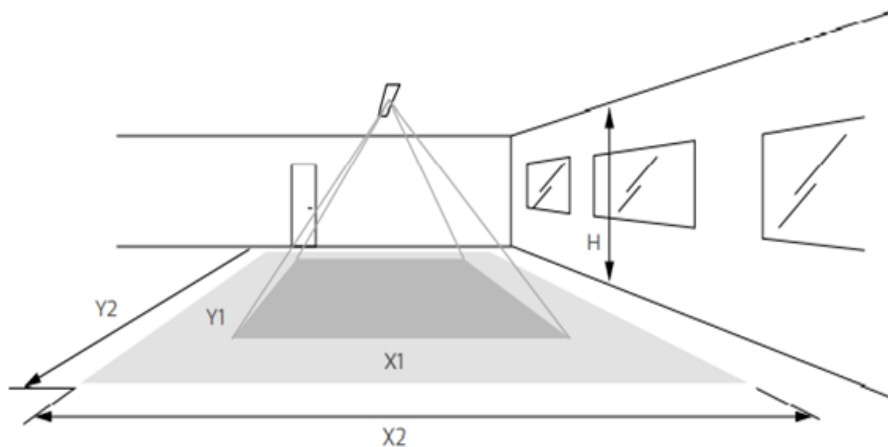

Daylight Sensor

The light sensor measures the total amount of light in a circular field of approximately 80% of the PIR detection area. The following aspects should be observed during installation:

- Minimum distance from the window = 2ft (0.6m).
- Prevent light reflections from outside entering the sensor (for example sunlight reflection on a car hood) as this will lead to incorrect light regulation.

As a guideline the formula $0.72 \times H$ can be used to calculate the minimum distance between the window and sensor whereby H is the height from the bottom of the window to the sensor.

Photosensor spatial response

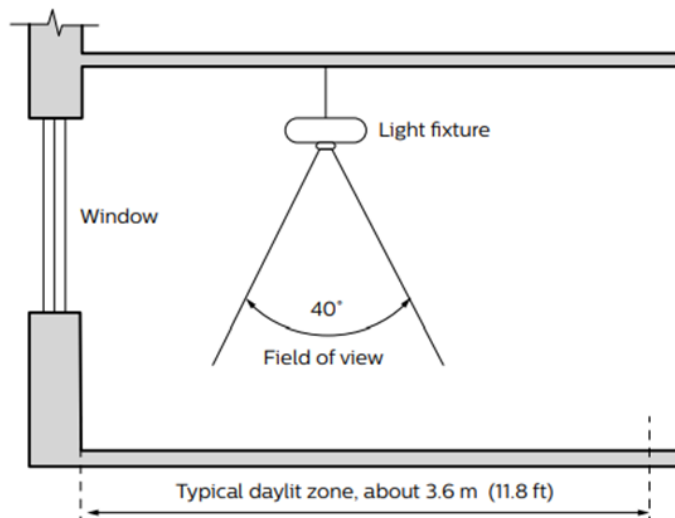

Height	Minor movement		Major movement	
h	X1	Y1	X2	Y2
2.4 m (7.9 ft)	1.9 m (6.2 ft)	2.9 m (9.5 ft)	2.9 m (9.5 ft)	4.3 m (14.1 ft)
3 m (9.8 ft)	2.4 m (7.9 ft)	3.6 m (11.8 ft)	3.6 m (11.8 ft)	5.4 m (17.7 ft)

The detection area for the movement sensor can be roughly divided into two parts;

- Minor movements (person moving = 3ft/s or 0.9m/s).
- Major movements (person moving = 3ft/s or 0.9m/s).

! ATTENTION: Install in accordance with national and local building and electrical codes.