

System Overview

These instructions review how to install Verge suspended fixtures. Verge 4ft and 8ft modules can be installed as individual standalone units, or they can be joined together to create continuous runs. The graphic below shows the components required to install a typical run of Verge suspended fixtures.

Verge joint kit(s)*

- A/C mounting bracket (x1)
- Break apart joiner aligner (x1)
- #8-B x 1/4" screw (x1)
- Gasket (x1)
- #10-24 locking nut (x2)
- #10-24 9/16 bolt (x2)

*NOTE: 1 kit required for each in-run joint.

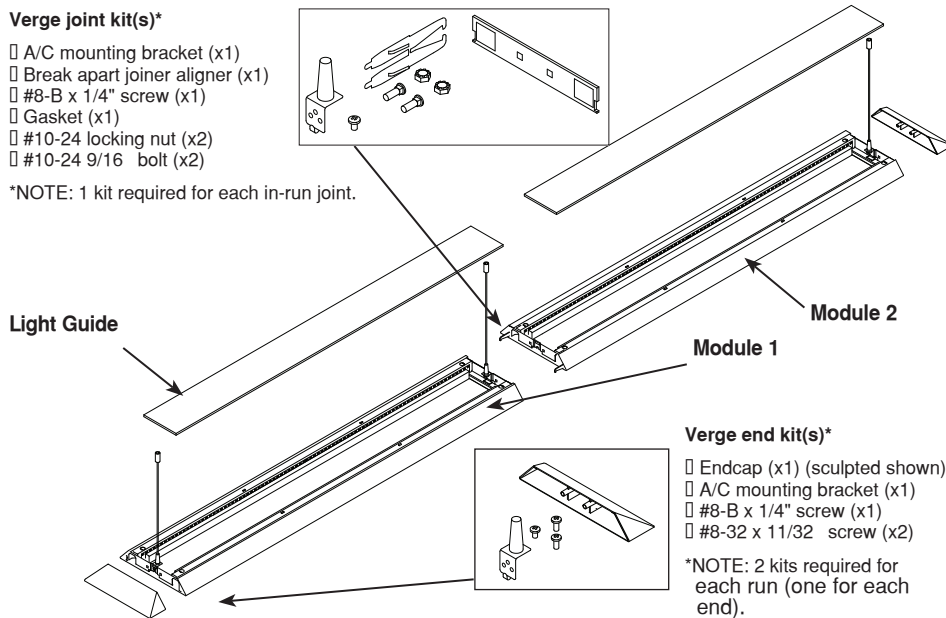

Verge end kit(s)*

- Endcap (x1) (sculpted shown)
- A/C mounting bracket (x1)
- #8-B x 1/4" screw (x1)
- #8-32 x 11/32 screw (x2)

*NOTE: 2 kits required for each run (one for each end).

TOOLS REQUIRED: Phillips screwdriver, 3/8 nut driver and flat or #2 Robertson screwdriver.

Module Lengths

Verge suspended systems come in 4ft and 8ft modules. Overall module lengths are shown below. Module lengths do not include endcaps.

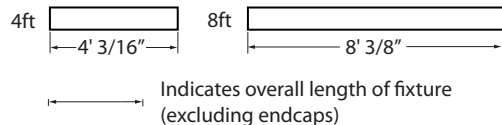

Endcaps

Add two endcaps to the length of each run.



Mount Spacing

For on-grid T-bar ceiling installations, mounts attach directly to Tee. For non-accessible ceilings and off-grid T-bar installations, the graphic below indicates mount spacing for typical row lengths. Mounting options are also available for a wide variety of other ceiling types. See Suspended Mounting Options document for more detailed information.

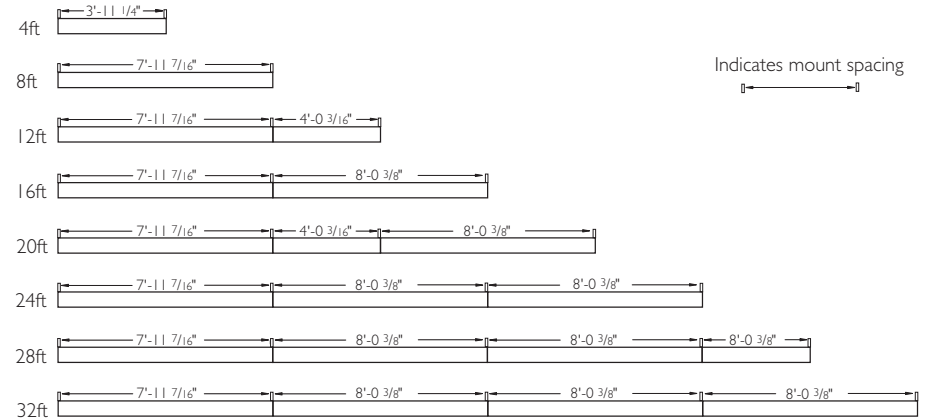

Row Configurations

The tables below indicate how 4ft and 8ft modules can be combined to create continuous rows of various lengths.

| Nominal row length | 4ft module | 8ft module |
|--------------------|------------|------------|
| 4' | 1x | |
| 8' | | 1x |
| 12' | 1x | 1x |
| 16' | | 2x |
| 20' | 1x | 2x |
| 24' | | 3x |
| 28' | 1x | 3x |
| 32' | | 4x |
| 36' | 1x | 4x |
| 40' | | 5x |
| 44' | 1x | 5x |
| 48' | | 6x |

| Nominal row length | 4ft module | 8ft module |
|--------------------|------------|------------|
| 56' | | 7x |
| 60' | 1x | 7x |
| 64' | | 8x |
| 68' | 1x | 8x |
| 72' | | 9x |
| 76' | 1x | 9x |
| 80' | | 10x |
| 84' | 1x | 10x |
| 88' | | 11x |
| 92' | 1x | 11x |
| 96' | | 12x |
| 100' | 1x | 12x |

*Overall row lengths provided do not include endcaps. Add two endcaps to the overall length of each row.



ATTENTION: Install in accordance with national and local building and electrical codes.

1 Prepare Fixtures / Install ceiling mounting components

Arrange boxed fixtures on floor in specified mounting locations; remove fixtures from boxes. Install all ceiling mounting components and vertical aircraft cables using separate installation instructions for Aircraft Cable Mounting (supplied).

NOTE: If conditions are dusty/dirty, recommended practice is to leave fixtures in their plastic bags. Cut small holes in the bag as needed to complete the following installation sequence, and then completely remove the bag from the fixture when conditions are clean. This prevents dust and dirt build-up on the fixtures.

2 Install End-of-Row Aircraft Cable Brackets

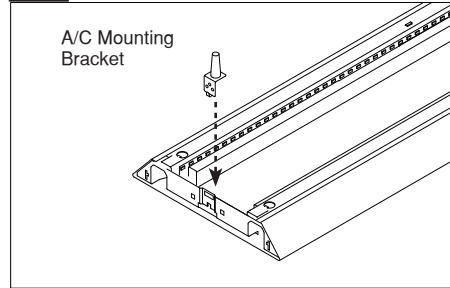

A. Hook A/C mounting bracket to endplate as shown. Raise bracket until security tab is engaged.

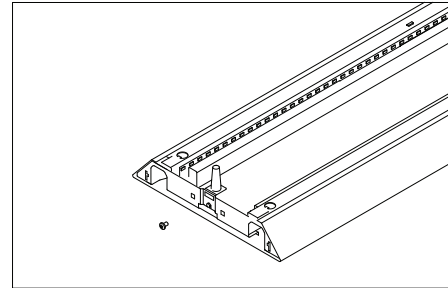

B. Attach bracket to fixture using supplied fastener.

NOTE: When installing individual modules, and the first fixture of a row, complete step 2 on both ends of fixture.

3 Suspend & Level First Fixture

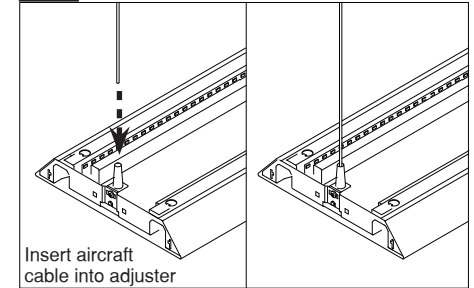

Insert aircraft cable into adjuster

With 2 people, raise the first fixture to the ceiling. At each end of the module, insert aircraft cable through aircraft cable adjuster (located on A/C mount bracket). The adjuster will automatically grip and hold the cable. **IMPORTANT:** Do not force cable into adjuster. See instruction A (next page) for details. Trim aircraft cable below adjuster as per instruction A (next page).

Level the fixture (see instruction B & C on next page).

4 Complete Electrical Connections

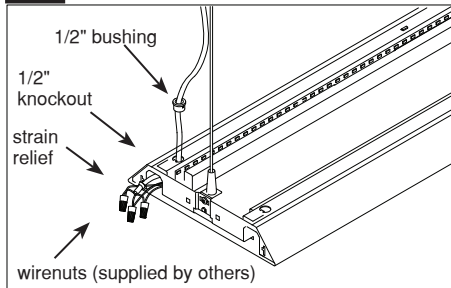

NON-POWER LOCATIONS: Cap all wires and tuck into wire cavity.

POWER LOCATIONS: Remove required 1/2" round knockout(s). Insert power cord and apply strain relief below the socket saddle to secure cord. Remove installed quick-wire connectors (if applicable) at power feed locations and complete electrical connections using wire nuts (supplied by others). Tuck wires into wire cavity.

NOTE: Use smallest appropriate wire nuts.

NOTE 2: Power feed connections can also be completed at joint locations.

5 Install in-row mount brackets and insert joiner aligners

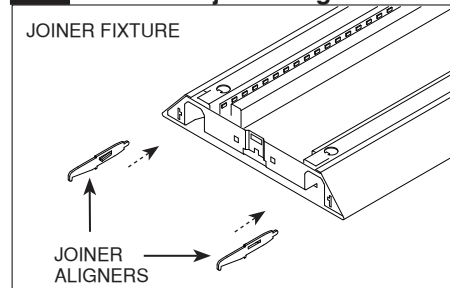

For each additional fixture in the row, at the end furthest from the existing suspended fixture, attach A/C mounting bracket to fixture using supplied fasteners (see step 2). At the end closest to the existing suspended fixture, insert joiner aligners into crossplate (aligners will lock into place).

6 Suspend and join additional fixtures to create row

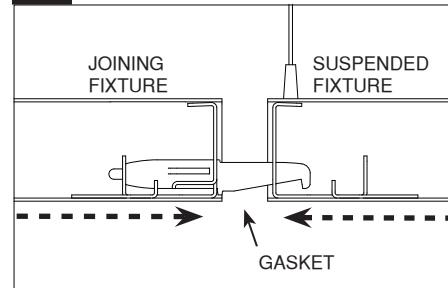

With two people, raise second fixture to ceiling.

At joint, insert joiner aligners through black gasket and into suspended fixture. At other end (opposite joint), insert aircraft cable through adjuster.

IMPORTANT: Do not attempt to join fixtures on floor. Instead, hang one fixture at a time and join modules at ceiling level.

7 Complete electrical connections at joints

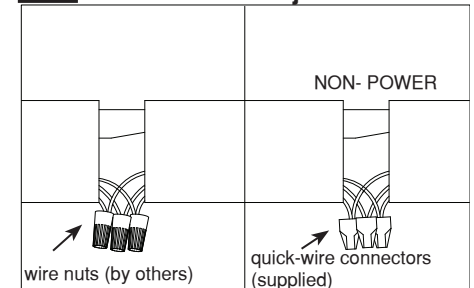

Complete in-row electrical connections.

NON-POWER LOCATIONS: Use supplied quick-wire connectors. Tuck wires into wire cavity.

POWER LOCATIONS: Remove installed quick-wire connectors and complete electrical connections using wire nuts (supplied by others). Tuck wires into wiring cavity.



ATTENTION: Install in accordance with national and local building and electrical codes.

8 Secure Joints

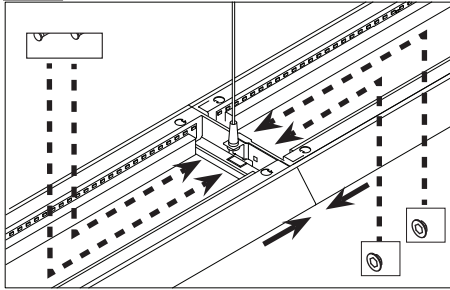

SLIDE MODULES TOGETHER: Secure joint from above using supplied nut and bolt hardware.

Repeat STEPS 5-8 for each additional fixture in row.

9 Install endcaps

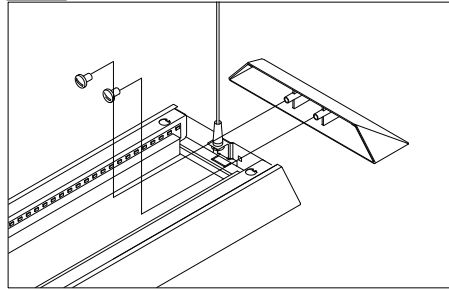

Attach end caps using supplied #8 screws.

IMPORTANT: Do not over-tighten endcap fasteners. Philips Ledalite recommends tightening fasteners by hand. When screwhead is flush with crossplate, turn an additional full turn.

10 Install Light Guide

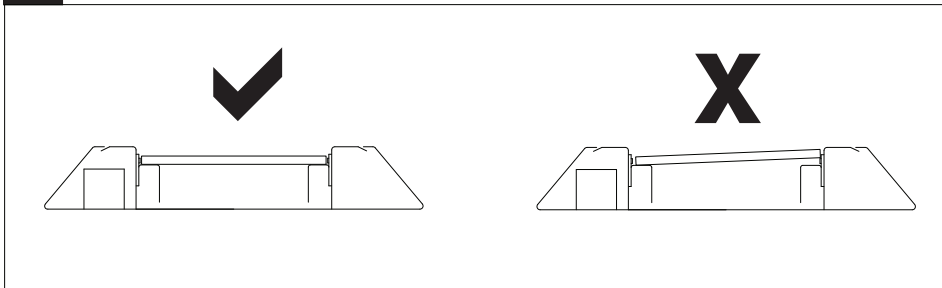

Identify smooth side of the Light Guide and ensure it is installed smooth side DOWN. Install Light Guide panel into LED fixture after joining and wiring is complete. Ensure panel is seated correctly as shown above.

A Aircraft cable adjustment

IMPORTANT: Do not force cable into adjuster. To insert cable into adjuster, follow the steps below.

1. CUT

If required, cut cable ends cleanly prior to inserting into adjuster. Recommended cutters: K.K. Porter cable cutter cat. No. 0690TN or Klein all purpose shears cat. No. 1104.

2. INSERT

Carefully insert cable into tapered end. If cable does not insert easily or becomes jammed during insertion, use the release tool to remove cable. Trim end and repeat process. **DO NOT BEND CABLE BELOW BOTTOM OF ADJUSTER.**

3. TEST

Once cable is inserted, apply a 25lb point load to each mount bracket to ensure all connections are secure.

NOTE: Ensure fixture is level end-to-end. Support fixture from below and use supplied aircraft cable release tool to make fine height adjustments.

B Level horizontally

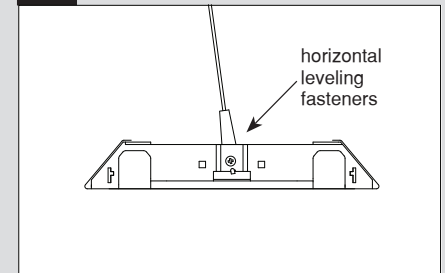

LEVEL HORIZONTALLY (shown above): Loosen fasteners on bottom of adjuster and level as required. Tighten fastener once fixture is in level position.

C Level vertically

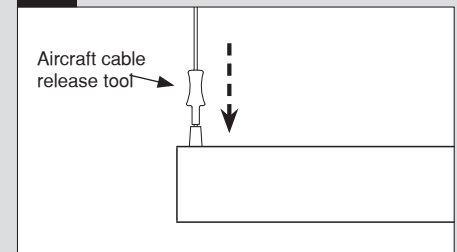

LEVEL VERTICALLY (shown above): Support fixture from below and use supplied aircraft cable release tool to make fine height adjustments (see instruction A for details).



ATTENTION: Install in accordance with national and local building and electrical codes.