

Day-Brite

CFI

by  Signify

Recessed

Coffaire 2x2

TT5



Project: _____

Location: _____

Cat.No: _____

Type: _____

Lamps: _____ Qty: _____

Notes: _____

Day-Brite / CFI Coffaire recessed adds a new dimension to recessed, indirect, perforated basket luminaires, air return! Coffaire combines a perforated mesh lamp shield with a white acrylic overlay in an indirect cove to create an aesthetically pleasing direct/indirect luminaire.

Ordering guide

Example: CFS2GPF2FTUNV-1/2-EB

Family	Air Function	Width	Ceiling Type	Diffuser	Overlay	No. of Lamps	Lamp Type (by others)	Voltage	Options
CF		2	G	P			FT	—	
CF Coffaire direct/indirect recessed with perforated mesh shield	H Air return S Static A Air supply and return	2 2'	G Fits both standard and slot grid	P Perforated lamp shield, matte white	F Acrylic overlay G Dust shield D Insect shield	2 2 lamp 3 3 lamp	FT 40WTT5	UNV Universal voltage, 120-277V 120 120V 277 277V 347 347V	1/2 One 2-lamp ballast 1/3 One 3-lamp ballast 1/21 2-lamp and 1-lamp ballasts EB Electronic ballast, <10% THD std. ballast factor EB101 Electronic ballast, instant start, <10% THD EBD7 Advance Mark 7 dimming ballast, 0-10V (low voltage) control EBDX Advance Mark 10 dimming ballast, phase control EBD Electronic dimming ballast, customer specified E5 B50 emerg. ballast, U.S. or Canada market, 1100-1400 lumens, UNV F1 3/8" flex, 3 wire 18 gauge 6' F2 3/8" flex, 4 wire 18 gauge 6' F2/5W 3/8" flex, 5 wire 18 gauge 6' GLR Fusing, fast blow LPT830 Installed lamps, 80+ CRI, 3000K LPT835 Installed lamps, 80+ CRI, 3500K LPT841 Installed lamps, 80+ CRI, 4100K CHIC Chicago plenum rated

Accessories (order separately)

- FMA22 – 2'x2' "F" mounting frame for NEMA "F" installations

CFH, CFS, & CFA Coffaire recessed 2x2

TT5

Features

- Direct/indirect lamp shield appearance with soft contoured interior.
- Perforated mesh lamp shield with white acrylic overlay.
- Contoured body and ends.
- 68.1% efficient (2 lamp), 55.2% efficient (3 lamp).
- Spacing to mounting ratio 1.4 (2 lamp), 1.3 (3 lamp).
- Only 5" deep.
- Tension bars secure ends to body.
- Same fixture fits both G and T ceiling.
- Fits flush to face of slot grid (T) ceiling.
- Static models have injection molded light stop at basket ends.
- Perforated lamp shield hinges from either side.
- Ballast accessible from room side.
- Can be continuous row mounted.
- Wiring access plate standard.
- Air return slots located above lamp shield (CFH, CFA models).
- Air supply slot located on either side of the reflector, visible from below (CFA models only).

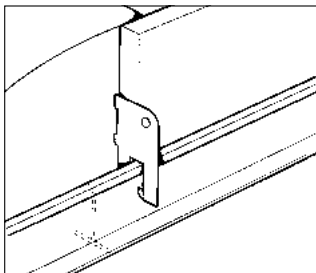

built-in earthquake clips

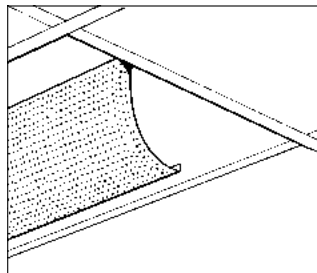

lamp shield hinges either side

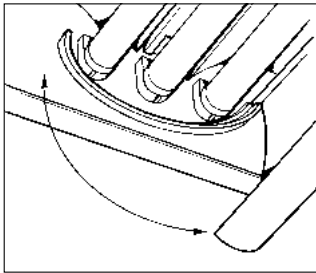

light stop, static models only

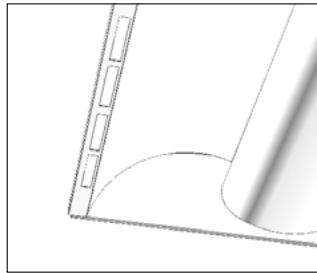

air slots for CFA models

Dimensions

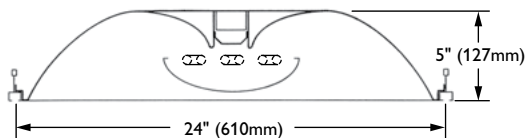

Specifications

- **Performance:** In an installation of 2 lamp 40WTT5 luminaires in a room cavity ratio of 1, with reflectance 80% ceiling, 50% wall, 20% floor, the C.U. shall not be less than .71. To reduce glare the average brightness at 65° shall not exceed 4641 candelas per square meter. To control veiling reflections, luminaire output in the 30°-90° zone shall not be less than 74.0%.
- **Materials:** Chassis parts – die-formed code gauge steel. Lamp Shield – steel perforated mesh lamp shield with white acrylic overlay.
- **Finish:** Chassis exterior – baked white post painted acrylic enamel. Cavity – baked matte white post painted acrylic enamel. Reflector – baked matte white post painted acrylic enamel, minimum 86% reflectance. Phosphate undercoating. Lamp Shield – baked matte white acrylic enamel.
- **Electrical:** Thermally protected class “P” ballast, non PCB. If K.O. is within 3" of ballast, use wire suitable for at least 90°.
- **Labels:** cULus listed, suitable for damp locations.

Mounting methods (CFH, CFS)

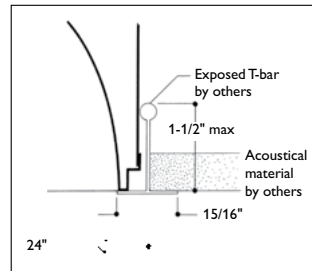

exposed t-grid ceiling

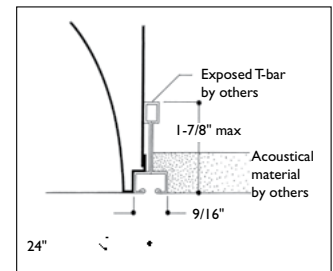

exposed slot t-grid ceiling

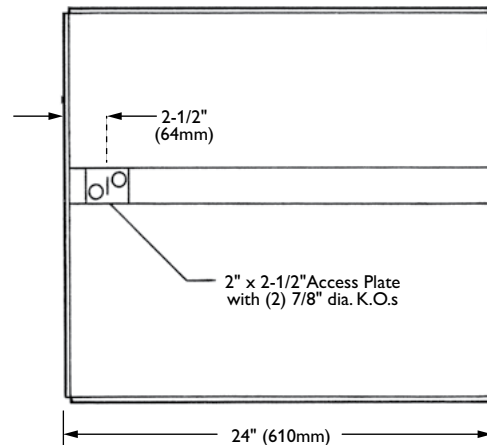

CFH, CFS, & CFA Coffaire recessed 2x2

TT5

Photometry

Model No. CFH2GPF2FT120-1/2-EB10I

Efficiency –68.1%

LER – 57

TER – 49

		Candlepower				Light Distribution				Average Luminance			
		Angle	End	45	Cross	Degrees	Lumens	% Lamp	% Luminaire	Angle	End	45'	Cross
Catalog No.	CFH2GPF2FT120-1/2-EB10I	0	1423	1423	1423	0-30	1114	17.7	26.0	45	3743	4273	4715
Test No.	G2004246	5	1416	1416	1417	0-40	1845	29.3	43.0	55	3441	4342	4882
S/MH	1.4	10	1391	1397	1404	0-60	3366	53.4	78.5	65	2953	4238	4643
Lamp Type	40WTT5	15	1354	1369	1385	0-90	4289	68.1	100.0	75	2280	3363	3420
Lumens/Lamp	3150	20	1304	1331	1360					85	1253	1794	1896
Ballast Factor	0.88	25	1242	1283	1331								
Input Watts	66	30	1171	1228	1294								
		35	1089	1168	1251								
		40	999	1100	1197								
		45	897	1024	1130								
		50	786	939	1049								
		55	669	844	949								
		60	547	733	822								
		65	423	607	665								
		70	305	464	475								
		75	200	295	300								
		80	111	155	180								
		85	37	53	56								

COEFFICIENTS OF UTILIZATION									
EFFECTIVE FLOOR CAVITY REFLECTANCE 20 PER (pfc=0.20)									
pcc	80			70			50		
	70	50	30	70	50	30	50	30	
pw	70	50	30	70	50	30	50	30	
RCR									
0	81	81	81	79	79	79	76	76	
1	73	70	68	71	68	67	66	64	
2	67	60	56	65	59	56	57	54	
3	60	54	47	58	53	46	51	46	
4	56	47	40	54	46	40	45	40	
5	51	41	35	50	41	35	40	34	
6	46	38	32	46	36	30	35	30	
7	44	34	28	42	34	28	33	28	
8	40	30	25	40	30	25	29	25	
9	38	28	23	36	28	23	27	23	
10	35	26	20	34	26	20	25	20	

Model No. CFH2GPF3FT120-1/3-EB10I

TER – 36

LER = FP - 41.2 IW - 111.1 BF - 0.88
 Comparative yearly lighting energy cost per 1000 lumens = \$5.85

Report Number: G2004247
Catalog Number: CFH2GPF3FT120-1/3-EB10I
Lamps: F40/TT5
Luminaire: Coffaire II with perforated basket
Ballast: UT340120
 Report is based on 3150 Lumens per lamp.
Efficiency: 55.2%
CIE Type: Direct
Plane: 0-Deg 90-Deg
Spacing Criteria: 1.2 1.3
Shielding Angles: 90 90
Plane: 0-Deg 90-Deg
Luminous Length: 22.920 22.920

CANDELA DISTRIBUTION

	0.0	45.0	90.0	FLUX
0	1878	1878	1878	
5	1848	1861	1878	177
15	1746	1789	1826	506
25	1582	1658	1726	766
35	1364	1479	1582	927
45	1100	1258	1386	966
55	796	995	1125	874
65	474	686	753	641
75	218	299	326	304
85	40	49	50	59
90	0	0	0	

ZONAL LUMEN SUMMARY

ZONE	LUMENS	% LAMP	% FIXT
0- 30	1449	15.3	27.8
0- 40	2376	25.1	45.5
0- 60	42316	44.6	80.8
0- 90	5219	55.2	100.0

LUMINANCE DATA IN CANDELA/SQ. METER

AVERAGE IN DEG.	AVERAGE 0-DEG.	AVERAGE 45-DEG.	AVERAGE 90-DEG.
45	4588.	5247.	5781.
55	4093.	5117.	5785.
65	3308.	4788.	5255.
75	2484.	3407.	3715.
85	1354.	1658.	1692.

COEFFICIENTS OF UTILIZATION – ZONAL CAVITY METHOD. EFFECTIVE FLOOR CAVITY REFLECTANCE 0.20

RC	80	50	30
RW	70	50	30
1	60	58	54
2	55	50	47
3	50	44	40
4	46	39	34
5	42	35	30
6	39	32	27
7	36	29	24
8	34	26	21
9	31	24	19
10	29	22	18



Some luminaires use fluorescent or high intensity discharge (HID) lamps that contain small amounts of mercury. Such lamps are labeled, "Contain Mercury" and/or the symbol "HG". Lamps that contain mercury must be disposed of in accordance with local requirements. Information regarding lamp recycling and disposal can be found at www.lamprecycle.org

