

**PSS / PSD > PLANT SUPPORT**

> shown here on a straight round pole

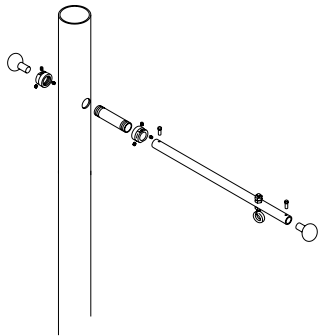

**PSS > Single plant support**

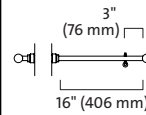

**PSD > Double plant support**

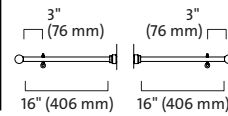

> **Maximum weight of 100 lbs (45.4 kg) on each side.**

**Specifications:**

Lumec's plant support arm **PS** are designed to fit round, fluted, square and multi-sided poles, using a central tubing inserted through two opposite 13/8" (35 mm) holes.

The steel arm [1 1/16" diameter (27 mm)] can then easily slip-fit into the plant support fitter, where it is secured by stainless steel hardware.

Completing the installation are two end-of-arm decorative casting.

Consult factory for all plant support heights and orientations.

> *Plant supports should hold plants at least 8 feet above the ground.*

> *Flower pot supplied by others.*

**Decorative end-of-arm option**   
**LF**

**PSACS / PSACD > PLANT SUPPORT**

EPA: 0.6 sq.ft. **Weight:** 8.0 lbs. (3.6 kg)

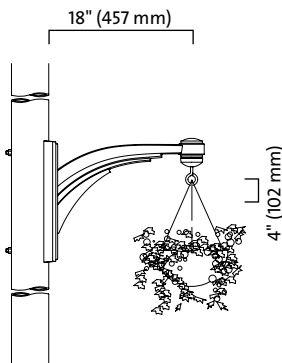

**PSACS > Single plant support**

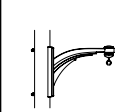

**PSACD > Double plant support**

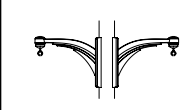

> **Maximum weight of 100 lbs (45.4 kg) on each side.**

**Specifications:**

Lumec's plant support arm **PSAC** features a cast-aluminum curved arm mechanically assembled to a cast-aluminum plate.

The plate is mechanically assembled with two bolts going through the pole.

Completing the installation is an eyelet to support the flower pot.

Consult factory for all plant support heights and orientations.

> *Plant supports should hold plants at least 8 feet above the ground.*

> *Flower pot supplied by others.*

**PSCRAS / PSCRAD > PLANT SUPPORT**

EPA: 0.5 sq.ft. **Weight:** 8.0 lbs. (3.6 kg)

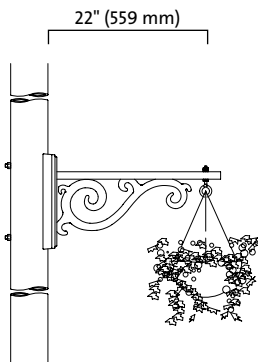

**PSCRAS > Single plant support**

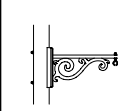

**PSCRAD > Double plant support**

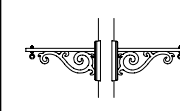

> **Maximum weight of 100 lbs (45.4 kg) on each side.**

**Specifications:**

Lumec's plant support arm **PSCRA** features a seamless 1" x 2" (25 x 51 mm) rectangular extruded aluminum tube and cast decorative scroll, welded to a cast-aluminum plate.

The plate is mechanically assembled with two bolts going through the pole.

Completing the installation is an eyelet to support the flower pot.

Consult factory for all plant support heights and orientations.

> *Plant supports should hold plants at least 8 feet above the ground.*

> *Flower pot supplied by others.*

**PSPCS / PSPCD > PLANT SUPPORT**

EPA: 0.4 sq.ft. **Weight:** 7.5 lbs. (3.4 kg)

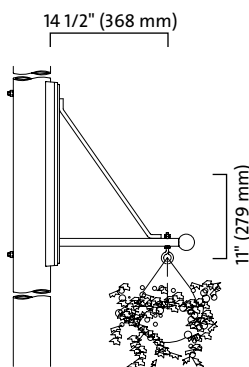

**PSPCS > Single plant support**

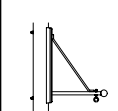

**PSPCD > Double plant support**

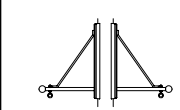

> **Maximum weight of 100 lbs (45.4 kg) on each side.**

**Specifications:**

Lumec's plant support arm **PSPC** features a 1 1/16" (27 mm) round extruded-aluminum arm welded to the cast-aluminum plate.

The plant support arm includes an extruded-aluminum decorative rod welded to the cast-aluminum plate and to the arm.

Completing the installation is an eyelet to support the flower pot.

Consult factory for all plant support heights and orientations.

> *Plant supports should hold plants at least 8 feet above the ground.*

> *Flower pot supplied by others.*



# PS > POLE OPTION DETAILS

## PSYRS / PSYRD > PLANT SUPPORT

EPA: 0.5 sq.ft. **Weight:** 7.6 lbs. (3.5 kg)

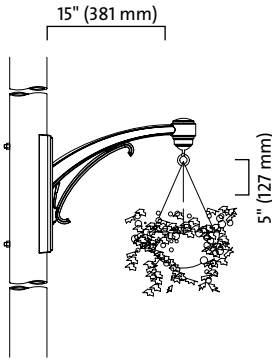

PSYRS > Single plant support



PSYRD > Double plant support

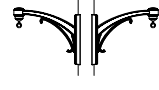

> **Maximum weight of 100 lbs (45.4 kg) on each side.**

### Specifications:

Lumec's plant support arm **PSYR** feature a cast-aluminum curved arm and a decorative element welded to a cast-aluminum plate.

Completing the installation is an eyelet to support the flower pot.

Consult factory for all plant support heights and orientations.

> *Plant supports should hold plants at least 8 feet above the ground.*

> *Flower pot supplied by others.*

## PSARS / PSARD > PLANT SUPPORT

EPA: 0.5 sq.ft. **Weight:** 8.0 lbs. (3.6 kg)

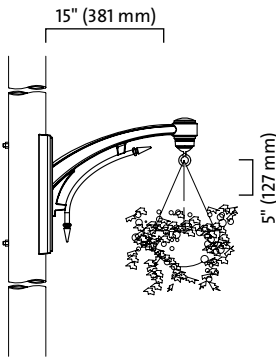

PSARS > Single plant support



PSARD > Double plant support

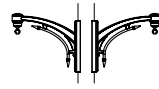

> **Maximum weight of 100 lbs (45.4 kg) on each side.**

### Specifications:

Lumec's plant support arm **PSAR** features a cast-aluminum curved arm and a decorative element welded to a cast-aluminum plate.

Completing the installation is an eyelet to support the flower pot.

Consult factory for all plant support heights and orientations.

> *Plant supports should hold plants at least 8 feet above the ground.*

> *Flower pot supplied by others.*

## PSCRFS / PSCRFD > PLANT SUPPORT

EPA: 0.6 sq.ft. **Weight:** 11 lbs. (5.0 kg)

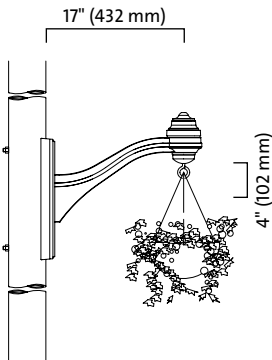

PSCRFS > Single plant support



PSCRFD > Double plant support

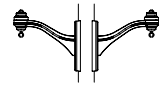

> **Maximum weight of 100 lbs (45.4 kg) on each side.**

### Specifications:

Lumec's plant support arm **PSCR** features a cast-aluminum curved arm mechanically assembled to a cast-aluminum plate.

Completing the installation is an eyelet to support the flower pot.

Consult factory for all plant support heights and orientations.

> *Plant supports should hold plants at least 8 feet above the ground.*

> *Flower pot supplied by others.*

## PSVCS / PSVCD > PLANT SUPPORT

EPA: 0.6 sq.ft. **Weight:** 9.6 lbs. (4.4 kg)

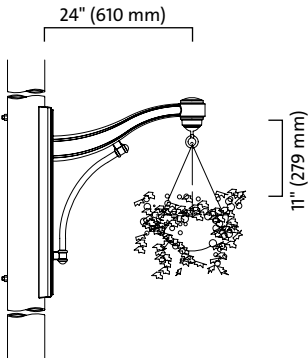

PSVCS > Single plant support



PSVCD > Double plant support

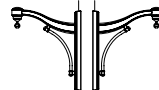

> **Maximum weight of 100 lbs (45.4 kg) on each side.**

### Specifications:

Lumec's plant support arm **PSVC** features a cast-aluminum curved arm and a cast-aluminum decorative scroll welded to a cast-aluminum plate.

Completing the installation is an eyelet to support the flower pot.

Consult factory for all plant support heights and orientations.

> *Plant supports should hold plants at least 8 feet above the ground.*

> *Flower pot supplied by others.*

