

Project: _____
 Location: _____
 Cat.No: _____
 Type: _____
 Lamps: _____ Qty: _____
 Notes: _____

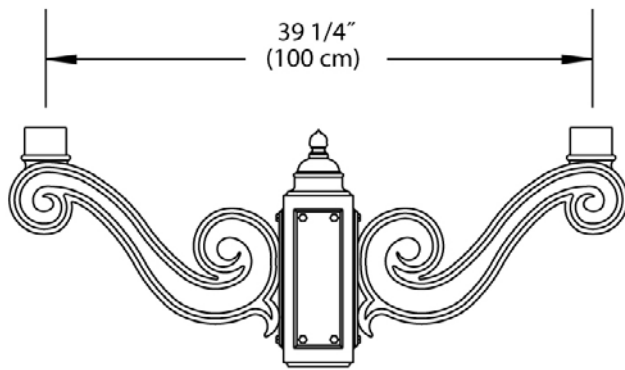

Ordering Guide

Example: PTH2540 P3 A

Product Code	PTH2540	Quad
Post diameter	P3 P4	3" Post Mount 4" Post Mount
Finish	A B G H J	Black White Verde Bronze Green

Specifications

HOUSING:

356 HM high-strength, low-copper, proprietary cast aluminum alloy .

FINISH:

Thermoset polyester powdercoat is electrostatically applied after a five-stage conversion cleaning process and bonded by heat fusion thermosetting. Laboratory tested for superior weatherability and fade resistance in accordance with ASTM B117 specifications. For larger projects where a custom color is required, contact the factory for more information.

MOUNTING:

Cast Aluminum Hub mounts to a 3" OD x 3" long (P3) [if applicable] or 4" OD x 6 1/2" long (P4) [if applicable] tenon and is secured with at least (3) 5/16"-18 stainless steel set screws.

WARRANTY:

Three-year limited warranty.

Height :

17" (43 cm)

Length:

39 1/4" (100 cm)

EPA:

2.95 sq. ft.

