

Day-Brite

CFI

by  Signify

Recessed

Coffaire HP 2x2

TT5



Project: _____
 Location: _____
 Cat.No: _____
 Type: _____
 Lamps: _____ Qty: _____
 Notes: _____

Day-Brite / CFI Coffaire HP recessed features a high 95% reflectance white powder painted body, our TransOptix lens and a 95% reflectance specular aluminum reflector. Coffaire HP combines a perforated mesh lamp shield with the TransOptix lens in an indirect cove to create an aesthetically pleasing direct/indirect luminaire.

Ordering guide

Example: CFS2GHP2FTUNV-1/2-EB

Family	Air Function	Width	Ceiling Type	Diffuser/ Reflector	No. of Lamps	Lamp Type (by others)	Voltage	Options
<input type="text" value="CF"/>	<input type="text" value="S"/>	<input type="text" value="2"/>		<input type="text" value="HP"/>	<input type="text" value="2"/>	<input type="text" value="FT"/>	—	
CF Coffaire HP direct/ indirect recessed with perforated mesh shield	S Static	2 2'	G Fits both standard and slot grid N 9/16" narrow T-grid	HP High performance	2 2 lamp	FT 40WTT5	UNV Universal voltage, 120-277V 120 120V 277 277V 347 347V	1/2 One 2-lamp ballast EB Electronic ballast, <10% THD std. ballast factor EB10I Electronic ballast, instant start, <10% THD EBD7 Advance Mark 7 dimming ballast, 0-10V (low voltage) control EBDX Advance Mark 10 dimming ballast, phase control EBD Electronic dimming ballast, customer specified E5 B50 emerg. ballast, U.S. or Canada market, 1100-1400 lumens, UNV F1 3/8" flex, 3 wire 18 gauge 6' F2 3/8" flex, 4 wire 18 gauge 6' F2/5W 3/8" flex, 5 wire 18 gauge 6' GLR Fusing, fast blow LPT830 Installed lamps, 80+ CRI, 3000K LPT835 Installed lamps, 80+ CRI, 3500K LPT841 Installed lamps, 80+ CRI, 4100K CHIC Chicago plenum rated

Accessories (order separately)

- FMA22 – 2'x2' "F" mounting frame for NEMA "F" installations

CFS Coffaire HP recessed 2x2

TT5

Features

- Direct/indirect lamp shield appearance with soft contoured interior.
- Perforated mesh lamp basket with unique TransOptix lens.
- Body 95% reflective matte white powder coated.
- 95% reflective specular reflector.
- 71.5% efficient (2 lamp 40WTT5).
- Spacing to mounting ratio 1.4 (2 lamp TT5).
- Only 5" deep.
- Tension screws secure ends to body.
- Same fixture fits both G and T ceiling types.
- Fits flush to face of slot grid (T) ceiling.
- Injection molded light stop at basket ends.
- Ballast accessible from room side.
- Perforated lamp shield hinges from either side.
- Can be continuous row mounted.
- Wiring access plate standard.

Specifications

- **Performance:** In an installation of 2 lamp 40WTT5 luminaires in a room cavity ratio of 1, with reflectance 80% ceiling, 50% wall, 20% floor, the C.U. shall not be less than .65. To reduce glare the average brightness at 65° shall not exceed 5360 candelas per square meter. To control veiling reflections, luminaire output in the 30°-90° zone shall not be less than 73.7%.
- **Materials:** Chassis parts – die-formed code gauge steel. Lamp Shield – steel perforated mesh lamp shield with unique TransOptix lens.
- **Finish:** Chassis exterior – 95% reflective white baked polyester enamel. Rust preventative undercoating. Cavity – 95% reflective white baked polyester enamel. Reflector – 95% reflective specular aluminum reflector. Lamp Shield – 95% reflective white baked polyester enamel.
- **Electrical:** Thermally protected class "P" ballast, non PCB. If K.O. is within 3" of ballast, use wire suitable for at least 90°.
- **Labels:** cULus listed, suitable for damp locations.

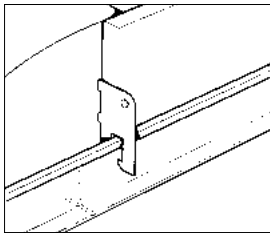

built-in earthquake clips

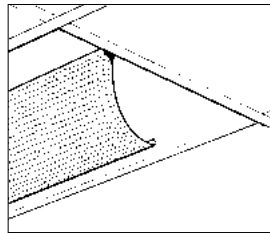

lamp shield hinges either side

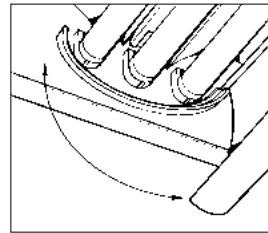

light stop, static models only

Mounting methods

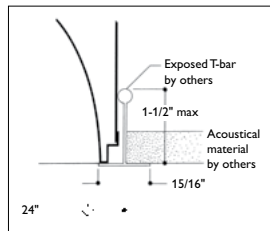

exposed t-grid ceiling

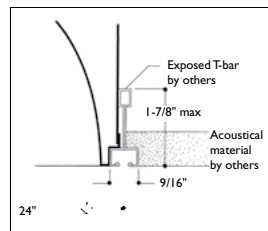

exposed slot t-grid ceiling

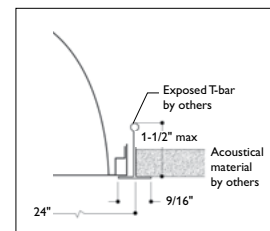

narrow exposed t-grid ceiling

Dimensions

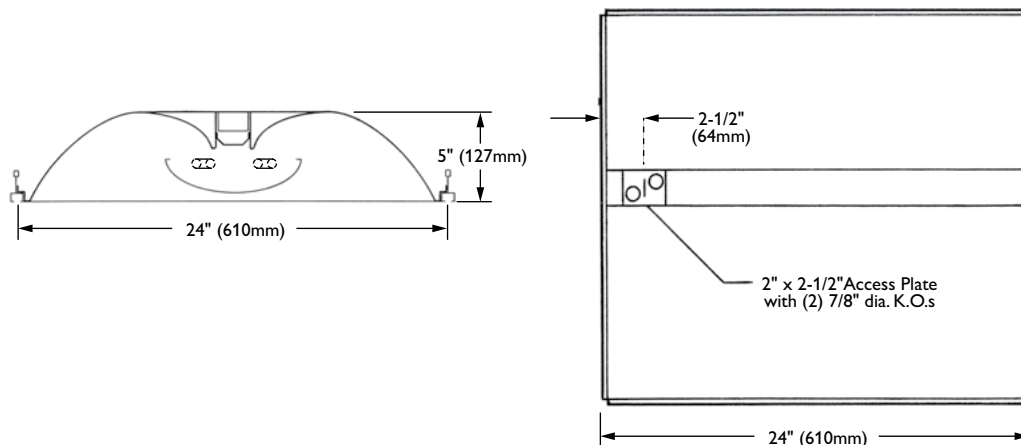

CFS Coffaire HP recessed 2x2

TT5

Photometry

Model No. CFS2GHP2FTUNV-1/2-EB10I – 40 Watt Lamps

LER = FP - 61.4 IW - 67.6 BF - 0.88
 Comparative yearly lighting energy cost per
 1000 lumens = \$3.91

Report Number: G2008288
Catalog Number: CFS2GHP2FTUNV-1/2-EB10I
Lamps: (2) PL-L40W/835/4P/RS/IS
Luminaire: Coffaire HP 2'x2' with 95%
 reflective white reflectors and perforated basket.
Ballast: ICN-2TTP40-SC Advance
 Report is based on 3300 Lumens per lamp.
Efficiency: 71.5%
CIE Type: Direct
Plane: 0-Deg 90-Deg
Spacing Criteria: 1.2 1.4
Shielding Angles: 90 90
Plane: 0-Deg 90-Deg
Luminous Length: 22.920 22.920

CANDELA DISTRIBUTION

	0.0	45.0	90.0	FLUX
0	1586	1586	1586	
5	1582	1577	1580	150
15	1509	1525	1544	431
25	1377	1426	1478	658
35	1192	1285	1382	806
45	963	1110	1250	856
55	705	905	1070	802
65	443	660	768	624
75	220	319	352	322
85	47	59	63	68
90	6	6	5	

ZONAL LUMEN SUMMARY

ZONE	LUMENS	% LAMP	% FIXT
0- 30	1240	18.8	26.3
0- 40	2046	31.0	43.4
0- 60	3703	56.1	78.5
0- 90	4717	71.5	100.0

LUMINANCE DATA IN CANDELA/SQ. METER

AVERAGE IN DEG.	AVERAGE 0-DEG.	AVERAGE 45-DEG.	AVERAGE 90-DEG.
45	4017	4630	5214
55	3625	4654	5502
65	3092	4606	5360
75	2507	3635	4011
85	1591	1997	3132

COEFFICIENTS OF UTILIZATION – ZONAL CAVITY METHOD. EFFECTIVE FLOOR CAVITY REFLECTANCE 0.20

RC	80	50	30	10	50	30	10
1	78	74	71	70	67	65	63
2	71	65	60	61	57	54	52
3	64	57	51	53	49	45	44
4	59	50	44	47	42	38	37
5	54	45	38	42	37	33	32
6	50	40	34	38	33	28	28
7	46	36	30	34	29	25	25
8	43	33	27	32	26	22	22
9	40	30	24	29	24	20	20
10	37	28	22	27	22	18	18



Some luminaires use fluorescent or high intensity discharge (HID) lamps that contain small amounts of mercury. Such lamps are labeled, "Contain Mercury" and/or the symbol "HG". Lamps that contain mercury must be disposed of in accordance with local requirements. Information regarding lamp recycling and disposal can be found at www.lamprecycle.org

